

EARLY DAYS  
OF TV: WHAT EVER  
HAPPENED TO CHANNEL 1?

\$1.25 MAR. 1982

# Radio- Electronics

Laser-scanned and compact  
**DIGITAL AUDIO DISC**

For super hi-fi

How it works:

**ROAD INFORMATION SYSTEM**

New use for FM SCA

Experimenter's notebook

**OPERATIONAL AMPLIFIERS**

How to design your own circuits

Build your own

**UHF ANTENNA PREAMP**

For better TV Reception

**GENERATORS**

workbench

**PLUS:**

HOBBY CORNER  
COMPUTER CORNER  
SERVICE CLINIC  
STATE-OF-SOLID-STATE



390736 DHM 09976093 GV A NOV82

MR ROBERT DAHM  
997 GRAND AV  
AURORA IL 60505



THE

# performers.

3 SMASH HITS... the 60 Series family  
Ruggedness • Safety • Overload Protection



These VOM's have X-TRA™ rugged construction that can take a 5 ft. drop onto a concrete floor! They're safety engineered throughout with an unusual diode and multiple fuse arrangement providing overload protection for all ranges. Single selector switch reduces errors, in fact, the 60's eliminate over 90% of costly repairs from VOM misuse.

**MODEL 60 VOM**—28 ranges, approved by Mining Enforcement and Safety Administration (2G-2880), only \$140.00. Model 60-A has 1½% DC accuracy plus mirrored scale, only \$151.00.

**MODEL 60-NA VOM**—50 ranges, 1½% DC accuracy, mirrored scale, multiplier switch, only \$191.00.

**MODEL 64 FET-VO**—FET design (high input impedance), Low-Power Ohms-LPΩ™—for in circuit testing, junction test circuit, exclusive MICRO POWER-TMP™ for long battery life under continuous operation, only \$202.00.

Prices include test leads, new screw-on insulated alligator clips for probes, batteries, spare fuses, instruction manual and 1 year warranty.

For a demonstration, contact your Triplett distributor, Mod Center or representative.

Triplett Corporation, Bluffton, Ohio 45817  
(419) 358-5015, TWX (810) 490-2400.

LOW AS **\$140**



Triplett performance... a tough act to follow

**TTT TRIPLETT**



# We take the nail-biting out of mail-order shopping.

## 16K RAM KITS . . . 13.95

Set of 8 NEC 4116 200 ns. Guaranteed one full year.

## DISKETTES

### ALPHA DISKS . . . 21.95

Single sided, certified Double Density 40 Tracks, with Hub-ring. Box of 10 Guaranteed one full year.

### VERBATIM DATALIFE

|                   |       |
|-------------------|-------|
| MD 525-01, 10, 16 | 26.50 |
| MD 550-01, 10, 16 | 44.50 |
| MD 557-01, 10, 16 | 45.60 |
| MD 577-01, 10, 16 | 34.80 |
| FD 32 or 34-9000  | 36.00 |
| FD 32 or 34-8000  | 44.95 |
| FD 34-4001        | 48.60 |

## DISKETTE STORAGE

|                                     |       |
|-------------------------------------|-------|
| 5 1/4" PLASTIC LIBRARY CASE         | 2.50  |
| 8" PLASTIC LIBRARY CASE             | 3.50  |
| PLASTIC STORAGE BINDER w/ Inserts   | 9.95  |
| PROTECTOR 5 1/4" (50 Disk Capacity) | 21.95 |
| PROTECTOR 8" (50 Disk Capacity)     | 24.95 |

## PRINTERS

|                              |         |
|------------------------------|---------|
| ANADEX DP 9500               | 1295.00 |
| ANADEX DP 9501               | 1295.00 |
| C-ITOH 25 CPS PARALLEL       | 1440.00 |
| C-ITOH 25 CPS SERIAL         | 1495.00 |
| C-ITOH 45 CPS PARALLEL       | 1770.00 |
| C-ITOH 40 CPS SERIAL         | 1870.00 |
| EPSON MX-80                  | \$CALL  |
| EPSON MX-80 F/T              | \$CALL  |
| EPSON MX-100 GRAPHIC         | \$CALL  |
| EPSON GRAFTRAX               | 90.00   |
| IDS-445G PAPER TIGER         | 779.00  |
| IDS-460G PAPER TIGER         | 945.00  |
| IDS-560G PAPER TIGER         | 1195.00 |
| NEC SPINWRITER 3510 S. RO    | 2195.00 |
| NEC SPINWRITER 3530 P. RO    | 2195.00 |
| NEC SPINWRITER 7710 S. RO    | 2645.00 |
| NEC SPINWRITER 7730 P. RO    | 2645.00 |
| NEC SPINWRITER 7700 D SELLUM | 2795.00 |
| NEC SPINWRITER 3500 SELLUM   | 2295.00 |
| OKIDATA MICROLINE 80         | 389.00  |
| OKIDATA MICROLINE 82A        | 569.00  |
| OKIDATA MICROLINE 83A        | 799.00  |
| OKIDATA MICROLINE 84         | 1199.00 |
| QUME 9/45                    | 2149.00 |
| MALIBU 200 DUAL MODE         | 2695.00 |

## APPLE HARDWARE

|                        |        |
|------------------------|--------|
| VERSA WRITER DIGITIZER | 259.00 |
| ABT APPLE KEYPAD       | 119.00 |

|                                  |        |
|----------------------------------|--------|
| MICROSOFT Z-80 SOFTWARE          | 299.00 |
| MICROSOFT RAMCARD                | 159.00 |
| VIDEX 80 x 24 VIDEO CARD         | 299.00 |
| VIDEX KEYBOARD ENHANCER II       | 129.00 |
| VIDEX ENHANCER REV 0-6           | 99.00  |
| VIDEX SOFT SWITCH                | 29.00  |
| M & R SUPERTERM 80 x 24 VIDEO 80 | 315.00 |
| NEC 12" GREEN MONITOR            | 199.00 |
| NEC 13" COLOR MONITOR            | 399.00 |
| SANYO 12" MONITOR (B & W)        | 249.00 |
| SANYO 12" MONITOR (GREEN)        | 269.00 |
| SANYO 13" COLOR MONITOR          | 469.00 |
| SSM AIO BOARD (INTERFACE) A & T  | 165.00 |
| SSM AIO BOARD (INTERFACE) KIT    | 135.00 |
| ZENITH 13" HI RES. GREEN MON     | 139.00 |
| APPLE FAN                        | 44.95  |
| T/G JOYSTICK                     | 54.95  |
| T/G PADDLE                       | 34.95  |
| VERSA E-Z PORT                   | 21.95  |
| MICRO SCI A40 W/CONTROLLER       | 479.00 |
| MICRO SCI A40 W/O CONTROLLER     | 409.00 |
| MICRO SCI A70 W/CONTROLLER       | 629.00 |
| MICRO SCI A70 W/O CONTROLLER     | 549.00 |
| THE MILL-PASCAL SPEED UP         | 329.00 |
| PROMETHEUS VERSACARD             | 229.00 |

## MODEMS

|                               |        |
|-------------------------------|--------|
| NOVATION CAT ACOUSTIC MODEM   | 145.00 |
| NOVATION D-CAT DIRECT CONNECT | 165.00 |
| NOVATION AUTO-CAT AUTO ANS    | 219.00 |
| NOVATION APPLE-CAT            | 349.00 |
| UDS 103 LP DIRECT CONNECT     | 175.00 |
| UDS 103 JLP AUTO ANS          | 209.00 |
| HAYES MICROMODEM II (APPLE)   | 299.00 |
| HAYES 100 MODEM (S-100)       | 325.00 |
| HAYES SMART MODEM (RS-232)    | 249.00 |
| HAYES CHRONOGRAPH             | 225.00 |
| LEXICON LX-11 MODEM           | 109.00 |

## ISOLATORS

|                |       |
|----------------|-------|
| ISO-1 3-SOCKET | 53.95 |
| ISO-2 6-SOCKET | 53.95 |

## BARE DRIVES

### TANDON 5 1/4 INCH

|                          |        |
|--------------------------|--------|
| 100-1 SINGLE HEAD 40 TRK | 219.00 |
| 100-2 DUAL HEAD 40 TRK   | 299.00 |
| 100-3 SINGLE HEAD 80 TRK | 299.00 |
| 100-4 DUAL HEAD 80 TRK   | 429.00 |

### TANDON THINLINE 8 INCH

|                   |        |
|-------------------|--------|
| 848-1 SINGLE SIDE | 459.00 |
| 848-2 DUAL SIDE   | 549.00 |

## MICRO PRO

### APPLE CP/M®

|            |        |
|------------|--------|
| WORDSTAR*  | 259.00 |
| SUPERSORT* | 145.00 |
| MAILMERGE* | 90.00  |
| DATASCOPE* | 215.00 |
| SPELLSTAR* | 169.00 |
| CALCSTAR*  | 239.00 |

### CP/M®

|           |        |
|-----------|--------|
| WORDSTAR  | 310.00 |
| SUPERSORT | 195.00 |
| MAILMERGE | 110.00 |
| DATASCOPE | 245.00 |
| SPELLSTAR | 195.00 |
| CALCSTAR  | 169.00 |

## MICROSOFT

|          |        |
|----------|--------|
| APPLE    |        |
| FORTRAN* | 165.00 |

|                         |        |
|-------------------------|--------|
| BASIC COMPILER*         | 315.00 |
| COBOL*                  | 595.00 |
| Z-80 SOFTWARE           | 299.00 |
| RAMCARD                 | 159.00 |
| TYPING TUTOR            | 17.95  |
| OLYMPIC DECATHLON       | 24.95  |
| TASC APPLESOFT COMPILER | 159.00 |

### CP/M®

|                |        |
|----------------|--------|
| BASIC 80       | 299.00 |
| BASIC COMPILER | 319.00 |
| FORTRAN 80     | 369.00 |
| COBOL 80       | 595.00 |

## APPLE SOFTWARE

|                                 |        |
|---------------------------------|--------|
| MAGIC WINDOW                    | 79.00  |
| DB MASTER (NEW)                 | 179.00 |
| PFS: PERSONAL FILING SYSTEM     | 79.00  |
| PFS: REPORT                     | 79.00  |
| Z-TERM*                         | 89.95  |
| ASCII EXPRESS                   | 63.95  |
| HAYDEN APPLESOFT COMPILER       | 149.00 |
| EASY WRITER-PRO                 | 199.00 |
| EXPEDITER II APPLESOFT COMPILER | 73.95  |
| A-STAT COMP. STATISTICS PKG.    | 119.00 |
| SUPER TEXT II                   | 129.00 |

## PERSONAL SOFTWARE

|                       |        |
|-----------------------|--------|
| DESKTOP PLAN II       | 159.00 |
| CCA DATA MGMT. SYSTEM | 89.00  |
| VISIPILOT             | 159.00 |
| VISITREND/VISIPILOT   | 199.00 |
| VISIDEX               | 159.00 |
| VISITERM              | 129.00 |
| VISICALC 3.3          | 159.00 |
| VISIFILES             | 199.00 |

## We built a reputation on our prices and your satisfaction.

We guarantee everything for 30 days. If anything is wrong, return the item and we'll make it right. And, of course, we'll pay the shipping charges.

We accept Visa and Master Card on all orders; COD orders, up to \$300.00.

Add \$2.00 for standard UPS shipping and handling on orders under 50 lbs, delivered in continental U.S. Call for shipping charges over 50 lbs. Foreign, FPO and APO orders, add 15% for shipping. Californians add 6% sales tax.

Prices quoted are for stock on hand and subject to change without notice.

To order, or for information, call:  
**(213) 706-0333**

31245 LA BAYA DRIVE, WESTLAKE VILLAGE, CALIFORNIA 91362

CIRCLE 45 ON FREE INFORMATION CARD

**Alpha  
Byte**  
**COMPUTER  
PRODUCTS**



# Save on Scanners! NEW Rebates!

Communications Electronics™ the world's largest distributor of radio scanners, celebrates 1982 with big savings on Bearcat scanners. Electra Company, the manufacturers of Bearcat scanners is offering consumer rebates on their great line of scanners, when purchased between February 1 and March 15, 1982.

With your scanner, you can monitor the exciting two-way radio conversations of police and fire departments, intelligence agencies, mobile telephones, energy/oil exploration crews, and more. Some scanners can even monitor aircraft transmissions! You can actually hear the news before it's news. If you do not own a scanner for yourself, now's the time to buy your new scanner from Communications Electronics. Choose the scanner that's right for you, then call our toll-free number to place your order with your Visa or Master Card.

We give you excellent service because CE distributes more scanners worldwide than anyone else. Our warehouse facilities are equipped to process thousands of scanner orders every week. We also export scanners to over 300 countries and military installations. Almost all items are in stock for quick shipment, so if you're a person who prefers fact to fantasy and who needs to know what's really happening around you, order your scanner today from CE!

## NEW! Bearcat® 350

**The Ultimate Synthesized Scanner!**  
List price \$599.95/CE price \$399.00/\$50.00 rebate  
Your final cost is a low \$349.00

**7-Band, 50 Channel • Alpha-Numeric • No-crystal scanner • AM Aircraft and Public Service bands • AC/DC Bands: 30-50, 118-136 AM, 144-174, 421-512 MHz.** The new Bearcat 350 introduces an incredible breakthrough in synthesized scanning: Alpha-Numeric Display. Push a button—and the Vacuum Fluorescent Display switches from "numeric" to word descriptions of what's being monitored. 50 channels in 5 banks. Plus, Auto & Manual Search, Search Direction, Limit & Count, Direct Channel Access, Selective Scan Delay, Dual Scan Speeds, Automatic Lockout, Automatic Squelch, Non-Volatile Memory. Order your Bearcat 350 today!

## Bearcat® 300

List price \$549.95/CE price \$349.00/\$50.00 rebate  
Your final cost is a low \$299.00

**7-Band, 50 Channel • Service Search • No-crystal scanner • AM Aircraft and Public Service bands • Priority Channel • AC/DC Bands: 30-50, 118-136 AM, 144-174, 421-512 MHz.** The Bearcat 300 is the most advanced automatic scanning radio that has ever been offered to the public. The Bearcat 300 uses a bright green fluorescent digital display, so it's ideal for mobile applications. The Bearcat 300 now has these added features: Service Search, Display Intensity Control, Hold Search and Resume Search keys, Separate Band keys to permit lock-in/lock-out of any band for more efficient service search.



## NEW! Bearcat® 350

## FREE Bearcat® Rebate Offer

Get a coupon good for a \$50 rebate when you purchase a Bearcat 350 or 300. \$25 rebate on model 250 or 20/20. \$15 rebate on model 210XL. \$10 rebate on model 160 or 4-6 Thin Scan. To get your rebate, mail rebate coupon with your original dated sales receipt and the Bearcat model number from the carton to Electra. You'll receive your rebate in four to six weeks. Offer valid only on purchases made between February 1, 1982 and March 15, 1982. All requests must be postmarked by March 31, 1982. Limit of one rebate per household. Coupon must accompany all rebate requests and may not be reproduced. Offer good only in the U.S.A. Void where taxed or prohibited by law. Resellers, companies, clubs and organizations—both profit and non-profit—are not eligible for rebates. Employees of Electra Company, their advertising agencies, distributors and retailers of Bearcat Scanners are also not eligible for rebates. Please be sure to send in the correct amount for your scanner. Pay the listed CE price in this ad. Do not deduct the rebate amount since your rebate will be sent directly to you from Electra. Orders received with insufficient payments will not be processed and will be returned. Offer subject to change without notice.

## Bearcat® 250

List price \$429.95/CE price \$279.00/\$25.00 rebate  
Your final cost is a low \$254.00

**6-Band, 50 Channel • Crystallless • Searches Stores • Recalls • Digital clock • AC/DC Priority Channel • 3-Band • Count Feature.** Frequency range 32-50, 146-174, 420-512 MHz. The Bearcat 250 performs any scanning function you could possibly want. With push button ease you can program up to 50 channels for automatic monitoring. Push another button and search for new frequencies. There are no crystals to limit what you want to hear. A special search feature of the Bearcat 250 actually stores 64 frequencies and recalls them, one at a time, at your convenience.

## NEW! Bearcat® 20/20

List price \$449.95/CE price \$289.00/\$25.00 rebate  
Your final cost is a low \$264.00

**7-Band, 40 Channel • Crystallless • Searches AM Aircraft and Public Service bands • AC/DC Priority Channel • Direct Channel Access • Delay** Frequency range 32-50, 118-136 AM, 144-174, 420-512 MHz. The Bearcat 20/20 automatic scanning radio replaces the Bearcat 220 and monitors 40 frequencies from 7 bands, including aircraft. A two-position switch, located on the front panel, allows monitoring of 20 channels at a time.

## Bearcat® 210XL

List price \$349.95/CE price \$229.00/\$15.00 rebate  
Your final cost is a low \$214.00

**6-Band, 18 Channel • Crystallless • AC/DC** Frequency range: 32-50, 144-174, 421-512 MHz. The Bearcat 210XL scanning radio is the second generation scanner that replaces the popular Bearcat 210 and 211. It has almost twice the scanning capacity of the Bearcat 210 with 18 channels plus dual scanning speeds and a bright green fluorescent display. Automatic search finds new frequencies. Features scan delay, single antenna, patented track tuning and more!

## Bearcat® 160

List price \$299.95/CE price \$194.00/\$10.00 rebate  
Your final cost is a low \$184.00

**5-Band, 16 Channel • AC only • Priority Dual Scan Speeds • Direct Channel Access** Frequency range: 32-50, 144-174, 440-512 MHz. The Bearcat 160 is the least expensive Bearcat crystallless scanner. Smooth keyboard. No buttons to punch. No knobs to turn. Instead, finger-tip pads provide control of all scanning operations.

## NEW! Bearcat® 100

**The first no-crystal programmable handheld scanner.** Allow 30-120 days for delivery after receipt of order due to the high demand for this product.

List price \$449.95/CE price \$299.00  
**8-Band, 16 Channel • Liquid Crystal Display Search • Limit • Hold • Lockout • AC/DC** Frequency range: 30-50, 138-174, 406-512 MHz.

The world's first no-crystal handheld scanner has compressed into a 3" x 7" x 1 1/4" case more scanning power than is found in many base or mobile scanners. The Bearcat 100 has a full 16 channels with frequency coverage that includes all public service bands (Low, High, UHF and "T" bands), the 2-Meter and 70 cm. Amateur bands, plus Military and Federal Government frequencies. It has chrome-plated keys for functions that are user controlled, such as lockout, manual and automatic scan. Even search is provided, both manual and automatic. Wow... what a scanner!

The Bearcat 100 produces audio power output of 300 milliwatts, is track-tuned and has selectivity of better than 50 dB down and sensitivity of 0.6 microvolts on VHF and 1.0 microvolts on UHF. Power consumption is kept extremely low by using a liquid crystal display and exclusive low power integrated circuits.

Included in our low CE price is a sturdy carrying case, earphone, battery charger/AC adapter, six AA Ni-cad batteries and flexible antenna. For earliest delivery from CE, reserve your Bearcat 100 today.

### TEST ANY SCANNER

Test any scanner purchased from Communications Electronics™ for 31 days before you decide to keep it. If for any reason you are not completely satisfied, return it in original condition with all parts in 31 days, for a prompt refund (less shipping/handling charges and rebate credits).

## Bearcat® Four-Six ThinScan™

List price \$189.95/CE price \$124.00/\$10.00 rebate  
Your final cost is a low \$114.00

Frequency range: 33-47, 152-164, 450-508 MHz. The incredible, Bearcat Four-Six Thin Scan™ is like having an information center in your pocket. This four band, 6 channel crystal controlled scanner has patented Track Tuning on UHF, Scan Delay and Channel Lockout. Measures 2 3/4 x 6 1/4 x 1 1/4". Includes rubber ducky antenna. Order crystal certificate for each channel. Made in Japan.

## Fanon Slimline 6-HLU

List price \$169.95/CE price \$109.00  
**Low cost 6-channel, 3-band scanner!**

The Fanon Slimline 6-HLU gives you six channels of crystal controlled excitement. Unique Automatic Peak Tuning Circuit adjusts the receiver front end for maximum sensitivity across the entire UHF band. Individual channel lockout switches. Frequency range 30-50, 146-175 and 450-512 MHz. Size 2 3/4 x 6 1/4 x 1 1/4". Includes rubber ducky antenna. If you don't need the UHF band, get the Fanon model 6-HL for \$99.00 each, and save money. Same high performance and features as the model HLU without the UHF band. Order crystal certificates for each channel. Made in Japan.

### OTHER SCANNERS & ACCESSORIES

|  |          |
|--|----------|
| NEW! Regency† D810 Scanner                         | \$319.00 |
| NEW! Regency† D300 Scanner                         | \$219.00 |
| NEW! Regency† D100 Scanner                         | \$169.00 |
| NEW! Regency† H604 Scanner                         | \$129.00 |
| Regency† M400 Scanner                              | \$259.00 |
| Regency† M100 Scanner                              | \$199.00 |
| Regency† R1040 Scanner                             | \$149.00 |
| SCMA-6 Fanon Mobile Adapter/Battery Charger        | \$49.00  |
| CHB-6 Fanon AC Adapter/Battery Charger             | \$15.00  |
| CAT-6 Fanon carrying case with belt clip           | \$15.00  |
| AUC-3 Fanon auto lighter adapter/Battery Charger   | \$15.00  |
| PSK-6 Base Power Supply/Bracket for SCMA-6         | \$20.00  |
| SP50 Bearcat AC Adapter                            | \$9.00   |
| SP51 Bearcat Battery Charger                       | \$9.00   |
| SP58 Bearcat 4-6 ThinScan™ carrying case           | \$12.00  |
| MA506 Regency carrying case for H604               | \$15.00  |
| FB-E Frequency Directory for Eastern U.S.A.        | \$12.00  |
| FB-W Frequency Directory for Western U.S.A.        | \$12.00  |
| FFD Federal Frequency Directory for U.S.A.         | \$12.00  |
| TSG† Top Secret† Registry of U.S. Government Freq. | \$10.00  |
| ASD Frequency Directory for Aircraft Band          | \$10.00  |
| B-4 1.2 V AAA Ni-Cad batteries (set of four)       | \$9.00   |
| A-135cc Crystal certificate                        | \$3.00   |

Add \$3.00 shipping for all accessories ordered at the same time.

### INCREASED PERFORMANCE ANTENNAS

If you want the utmost in performance from your scanner, it's essential that you use an external antenna. We have six base and mobile antennas specifically designed for receiving all bands. Order #A60 is a magnet mount mobile antenna. Order #A61 is a gutter clip mobile antenna. Order #A62 is a trunk-lip mobile antenna. Order #A63 is a 3/4 inch hole mount. Order #A64 is a 3/8 inch snap-in mount, and #A70 is an all band base station antenna. All antennas are \$35.00 and \$3.00 for UPS shipping in the continental United States.

### BUY WITH CONFIDENCE

To get the fastest delivery from CE of any scanner, send or phone your order directly to our Scanner Distribution Center. Be sure to calculate your price using the CE prices in this ad. Michigan residents please add 4% sales tax. Written purchase orders are accepted from approved government agencies and most well rated firms at a 10% surcharge for net 10 billing. All sales are subject to availability, acceptance and verification. All sales on accessories are final. Prices, terms and specifications are subject to change without notice. Out of stock items will be placed on backorder automatically unless CE is instructed differently. Most products that we sell have a manufacturer's warranty. Free copies of warranties on these products are available prior to purchase by writing to CE. International orders are invited with a \$20.00 surcharge for special handling in addition to shipping charges. All shipments are F.O.B. Ann Arbor, Michigan. No COD's please. Non-certified and foreign checks require bank clearance. Minimum order \$35.00.

Mail orders to: Communications Electronics™, Box 1002, Ann Arbor, Michigan 48106 U.S.A. Add \$7.00 per scanner or phone product for U.P.S. ground shipping and handling, or \$14.00 for faster U.P.S. air shipping to some locations. If you have a Visa or Master Card, you may call anytime and place a credit card order. Order toll free in the U.S.A. Dial 800-521-4414. If you are outside the U.S. or in Michigan, dial 313-994-4444. Dealer inquiries invited. Order without obligation today!

Scanner Distribution Center™ and CE logos are trademarks of Communications Electronics™.

† Bearcat is a federally registered trademark of Electra Company, a Division of Masco Corporation of Indiana.

‡ Regency is a federally registered trademark of Regency Electronics Inc. AD #1121081

Copyright 1982 Communications Electronics™



854 Phoenix □ Box 1002 □ Ann Arbor, Michigan 48106 U.S.A.  
Call TOLL-FREE (800) 521-4414 or outside U.S.A. (313) 994-4444



**SPECIAL FEATURE**

- 39 **DIGITAL AUDIO DISCS**  
Soon, for about the price of a good turntable, you'll be able to have true digital sound-reproduction in your listening room. **Len Feldman**

**BUILD THIS**

- 51 **TELEPHONE IN-USE MONITOR**  
A simple device to tell you when a multi-phone system is in use. **Christopher M. Dunn**
- 59 **UHF-TV ANTENNA PREAMP**  
How to get 25 dB of gain on UHF channels. **Ray Pichulo**

**TECHNOLOGY**

- 4 **VIDEO ELECTRONICS**  
Tomorrow's news and technology in this quickly changing industry. **David Lachenbruch**
- 23 **SATELLITE/TELETEXT NEWS**  
The latest happenings in communications technology. **Gary H. Arlen**
- 47 **AUTOMATIC ROAD INFORMATION SYSTEM**  
A new and practical use for FM SCA. **Len Feldman**
- 78 **STATE-OF-SOLID-STATE**  
Musical IC's. **Robert F. Scott**

**CIRCUITS AND COMPONENTS**

- 54 **DESIGNING WITH OP-AMPS**  
How operational amplifiers work and how you can use them in your own circuits. **Joseph J. Carr**
- 63 **TROUBLESHOOTING DIGITAL CIRCUITS**  
An easy transition from working with analog-circuit problems to digital ones. **Robert L. Goodman**
- 66 **ALL ABOUT PULSE GENERATORS**  
An introduction to a very useful tool for checking out digital logic-circuits. **Charles Gilmore**
- 70 **HOBBY CORNER**  
Turn a calculator into a capacitance meter (or ohmmeter, speedometer, etc.). **Earl "Doc" Savage, K4SDS**

**VIDEO**

- 43 **WHATEVER HAPPENED TO CHANNEL 1?**  
Why do TV tuners start with channel 2? **David A. Ferre**
- 52 **TV-IF ALIGNMENT**  
A simple approach to what really isn't as complex a process as it looks. **Jack Darr**
- 80 **SERVICE CLINIC**  
Vertical-retrace-line problems. **Jack Darr**
- 81 **SERVICE QUESTIONS**  
R-E's Service Editor solves technicians' problems. **Jack Darr**

**COMPUTERS**

- 76 **COMPUTER CORNER**  
Games (computer) people play. **Les Spindle**

**RADIO**

- 74 **COMMUNICATIONS CORNER**  
How speech scramblers work. **Herb Friedman**

**EQUIPMENT REPORTS**

- 26 **Realistic PRO-2020 Programmable Scanner**
- 35 **GC Electronics Magmeter Microwave Oven Tester**

**DEPARTMENTS**

- |                                  |                  |
|----------------------------------|------------------|
| 14 Advertising and Sales Offices | 16 Letters       |
| 118 Advertising Index            | 90 Market Center |
| 83 Books                         | 84 New Products  |
| 92 Computer Market Center        | 6 What's News    |
| 119 Free Information Card        |                  |

**ON THE COVER**

So far, the only way you could hear real digital sound reproduced on your own equipment was to invest in a \$3000 PCM attachment for your VCR. Shortly, though, digital audio, using your existing amplifier and speakers, will be available for about the cost of a good turntable. New techniques—particularly in the area of laser scanning—will put 60 minutes of ultra-high-fidelity audio on one side of a disc you can hold in the palm of your hand. To find out what's in store, and how it works, turn to page 39.

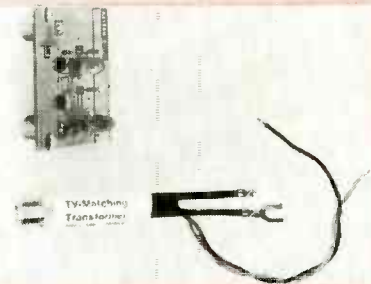

**GOOD UHF TELEVISION RECEPTION** has always been more difficult to get than VHF. Part of the solution lies in a good antenna-system. An antenna-mounted preamplifier can also help. A preamp you can build that offers 25-dB of gain is described starting on page 59.

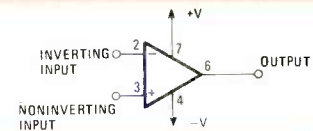

**OPERATIONAL AMPLIFIERS (OP-AMPS)** are an important—but frequently misunderstood—member of the IC family. Learn what makes them so useful and how to work with them beginning on page 54.

Radio-Electronics, (ISSN 0033-7862) Published monthly by Gernsback Publications, Inc., 200 Park Avenue South, New York, NY 10003. Second-Class Postage Paid at New York, N.Y. and additional mailing offices. One-year subscription rate: U.S.A. and U.S. possessions, \$13.00. Canada, \$16.00. Other countries, \$20.50 (cash orders only, payable in U.S.A. currency.) Single copies \$1.25. © 1982 by Gernsback Publications, Inc. All Rights reserved. Printed in U.S.A.

**Subscription Service:** Mail all subscription orders, changes, correspondence and Postmaster Notices of undelivered copies (Form 3579) to Radio-Electronics Subscription Service, Box 2520, Boulder, CO 80322.

A stamped self-addressed envelope must accompany all submitted manuscripts and/or artwork or photographs if their return is desired should they be rejected. We disclaim any responsibility for the loss or damage of manuscripts and/or artwork or photographs while in our possession or otherwise.

# VIDEO ELECTRONICS

DAVID LACHENBRUCH  
CONTRIBUTING EDITOR

## VCR DILEMMA

How to cope with the legal problems posed by the technological revolution is becoming a major political issue. Nowhere else is that as evident as it is in the case of home videotaping. In this instance, the immediate issue is whether private individuals who tape copyrighted programs off the air, or from cable TV, should pay for the privilege—and if so, how. The Appeals Court ruling in the Betamax case held that taping of such shows for personal viewing is a violation of the Copyright Law, and that manufacturers and sellers of VCR's are contributory infringers of the law. The three-judge court's decision indicated strongly that because Congress hadn't considered video technology when it passed the recent, revised, Copyright Law, perhaps congressional action would be necessary to cope with the problem.

Although the decision is being appealed to the Supreme Court, the action is likely to occur in Congress, where legislation has been introduced both to permit free taping and to add a fee to VCR's and/or videocassettes to be paid to the copyright holders of TV programs. The major antagonists are the electronics manufacturers, represented by the EIA, and the big movie companies, represented by Motion Picture Association of America. The EIA and its adherents argue that "time-shift" taping is merely another way of viewing a program at a more convenient time, accomplished in the privacy of the taper/viewer's home, and that the copyright owner of the program has already been paid for the televising of the show. The MPAA counters that home taping robs the copyright owner of his product without compensation and, at the very least, diminishes the value of the program in re-runs.

## RENTABETA

In pre-recorded videocassettes, rental is becoming a major business. One study has indicated that for every program cassette sold, 20 are rented. But in the past, movie-cassette rental was open only to the 3% of the population who owned video recorders. Now the opportunity is being extended to the other 97%—the non VCR owners—through Rentabeta, developed by Superscope.

The principle of Rentabeta is simple—"the take-home movie in a video player." The rental package includes a Toshiba portable VCR, specially modified so that it is a play-only machine, in a case which can be locked by the dealer so the cassette cannot be removed. The customer chooses the cassette he wishes, it's loaded by the dealer into the player, and he carries the entire package home. Although rentals are expected to differ from dealer to dealer, the suggested price for rental of a machine loaded with one cassette is \$8. Dealers may supply more than one cassette and leave the player unlocked so that the viewers can change cassettes themselves. Rentabeta players can be modified so they can't be rewound, permitting each cassette to be viewed only once. That has been suggested as a possible method of keeping positive track of the number of times each cassette has been viewed, so that producers of the rented movies can be paid royalties.

## KODAK ANSWERS SONY

Responding to Sony's Mavica electronic still-camera (see **Radio-Electronics**, January 1982), Eastman Kodak President Colby Chandler said that his company had the capability to build an all-electronic camera. However, the solid-state sensor alone would cost as much as an entire film-camera, and picture information per frame would be about one-quarter that of a 110-size film frame or  $1/20$  of a 35-mm frame. He said that an electronic sensor with a million picture elements could make an acceptable 2×4-inch print, but he noted that a 110 frame has more than 2 million elements, and 35mm over 10 million (while Sony's Mavica sensor has 280,000).

He hinted at a possible Eastman Kodak electronic film-viewing system combining chemical and electronic technology, in these words: "Along with their initial print order, users of such a system might receive an image carrier that drops easily into a videoplayer attached to a TV set. With a hand-held remote unit, consumers might have selective control of images on the TV screen. At the touch of a button, the user could enlarge its image and freeze it for closer viewing. At the touch of another, the viewer could encode the film frame. Now the image—as the viewer has chosen to see it—would return to view in the form selected, when next it is inserted in the player." He indicated that that is one product being evaluated for the consumer market. **R-E**



**ADVANCE IS PROUD TO INTRODUCE**  
**The  HITACHI Line**  
**of High Quality Oscilloscopes**  
**All Hitachi Instruments**  
**Are Backed by**  
**A Two-Year Warranty**

**AT LAST A 100MHz OSCILLOSCOPE**  
**WORTH WAITING FOR**  
**WITH NO WAITING**

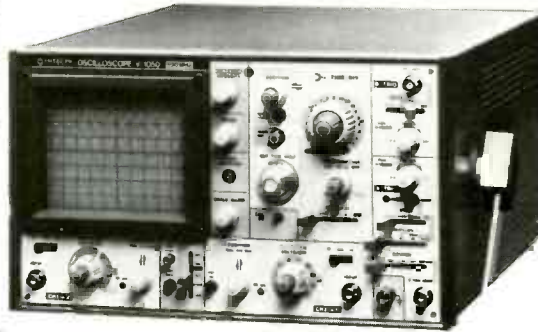

**CALL FOR**  
**INTRODUCTORY**  
**OFFER**

**HITACHI**  
**100MHz**  
**OSCILLOSCOPE**  
**MODEL V-1050**

**V-202 & V352**  
**20MHz & 35MHz DUAL TRACE**  
**OSCILLOSCOPES**



- 20kV CRT supply
- Large, bright 8 x 10 cm screen
- Four-trace operation (Ch1, Ch2, A trigger, B trigger)
- High sensitivity 500 uV/div (5MHz)
- High accuracy  $\pm 2\%$  (+10°C to 35°C)
- Alternate timebase operation
- Full TV triggering

**IN STOCK FOR**  
**IMMEDIATE DELIVERY**

Type  
 Hitachi 150BNB31 rectangular mean type tube with 20kV acceleration potential and metal backed phosphor

**VERTICAL DEFLECTION (2 identical Channels)**

Bandwidth and Rise Time  
 DC to at least 100MHz and rise time 3.5ns or less. DC to at least 5MHz and rise time 70ns or less at 10 X magnification. Lower -3db point, AC coupling 10Hz or less. 10x probe: 1Hz or less.

**HORIZONTAL DEFLECTION**

Time Base A  
 20ns/div. to 0.5s/div. in 23 calibrated steps, 1-2-5 sequence. Uncalibrated continuous control between steps 1: < 2.5

Time Base B  
 20ns/div. to 50ms/div. in 20 calibrated steps 1-2-5 sequence. 10x mag extends fastest sweep rate to 2ns/div.

Calibrated Sweep Delay  
 Continuous calibrated control between 0.5 and 10x time base A setting.

- NEW**
1. Square CRT with internal graticule (illuminated scale)
  2. High-accuracy voltage axis and time axis set at  $\pm 3\%$  (certified at 10° to 35°C)
  3. High-sensitivity 1mV/div
  4. Low drift
  5. Dynamic range 8 div.
  6. TV sync-separator circuit
  7. Built-in signal delay line (V-352)
  8. X-Y operation
  9. Sweep-time magnifier (10 times)
  10. Trace rotation system
  11. Fine-adjusting, click-positioning function

**UP TO \$500**  
**WITH SPECIAL REBATES**

**V-550B 50MHz, DUAL TRACE DELAYED SWEEP**  
**PORTABLE OSCILLOSCOPE**



Delayed sweep permits 1,000 X Magnification

Variable Hold-off Circuitry Facilitates Pulse Measurement

- Large, Bright 8 x 10cm Screen
- High Sensitivity 1mv/div (10MHz)
- 5 ns/div Sweep Rate
- 3rd Channel Display (Trigger View)
- Variable Trigger Hold-off
- Full TV Triggering
- Single Sweep
- Automatic Focus Correction

**ADVANCE ELECTRONICS**

**THE TEST EQUIPMENT SPECIALISTS**

**TOLL FREE HOT LINE**  
**800-223-0474**



54 WEST 45th STREET, NEW YORK, N.Y. 10036 212-687-2224

# WHAT'S NEWS

## New device cuts HV transmission losses

A new type of thyristor (silicon controlled rectifier) that promises to slash operating costs of high-voltage direct current (HVDC) power-transmission lines, was described by GE scientist Victor Temple at the International Electron Devices Meeting at Washington, DC, last December. Thyristors are power semiconductor-devices that are used to switch and control large amounts of electric power, turning it on and off in a few microseconds.

HVDC lines can carry twice as much power as AC lines with the same peak voltage rating,

thus slashing transmission costs. But the high costs of the converter stations that turn the AC into DC for long-distance transmission and back into AC for local distribution can cut deeply into those savings.

Thyristors for HVDC application are made from thin, .04-inch thick slices of silicon that are three inches in diameter. Normally they are activated by an electrical gate current. The new thyristor is activated by weak pulses of light carried on fiber-optic cables. Because of its innovative design, it can handle large currents while consuming little power itself, thus reducing converter-station losses.

Light-activated thyristors are

not new, but all previous types have had the disadvantage that the weak gate signal activates only a small portion of the thyristor. The current pouring through heats that portion to unsafe temperatures, and may cause melting breakdown.

In the new thyristor, resistors inserted in the silicon wafer between amplifying stages limit the current to safe levels. A resistor is etched in the wafer between the gate-amplifying stage and the pilot-amplifying stage. Another resistor is inserted between the pilot and the main stage.

In addition to HVDC converter stations, GE's light-fired thyristor has potential power-control applications in heavy industry, such as steel mills, and in locomotives.

## Tektronix opens direct mail center

On January 1, 1982, Tektronix opened a direct-order channel, through which purchasers, by calling a toll-free number, may obtain information or order instruments.

The National Marketing Center, in Beaverton, OR, will expand customer service as well as meet the needs of new electronics purchasers. By calling 1-800-547-1845, customers can reach experienced sales engineers who will supply immediate technical consultation, applications assistance, and answers to a wide variety of measurement and safety problems.

The Center offers a direct contact for customers who purchase just one or two instruments and would not normally be served by a field service engineer.

The toll-free number will be staffed from 5 am EST till 8 pm EST.

## Right to videotape supported by EIA

The right to private citizens to tape television programs for their own use must be protected

by law at once, testified Jack Wayman, Senior Vice President of the Consumer Electronics Group of the Electronic Industries Association, before the U.S. Senate Judiciary Committee. That legislation is necessary, he said, as a result of the recent court decision that holds it illegal for consumers to videotape selected programs off the air, even for private, non-commercial use.

Wayman pointed out that, in general, copyright owners are not damaged by private taping of TV. "Surveys show," he said, "that 70 to 90 percent of all VCR owners use their VCR's primarily to 'time shift'—to view programs they could not have watched at the time of transmission." That kind of taping indirectly benefits the copyright owner by increasing the broadcast audience and thus the value of the program to the broadcaster.

If Senate Bill 1758, legalizing private copying, is not passed immediately, Wayman said, some movie company might obtain an injunction against VCR's. That could cause severe economic damage not only to manufacturers, but to the dozens of American companies that distribute the product, and the more than 25,000 retail outlets that are now selling VCR's as well as blank and pre-recorded tapes. The industry could be paralyzed for a long time, while the matter remained in litigation, possibly going all the way to the Supreme Court.

The analogous right to record audio material has never been seriously challenged, as long as the recordings were not offered for sale, though drastic penalties have been imposed for selling such recordings.

## Fort Worth will get a videotext system

Tandy Corp./Radio Shack plan to install and operate an electronic information base (videotext) in the Fort Worth/Tarrant County area. Objectives will be to provide subscribers with continuously updated information,

*continued on page 12*

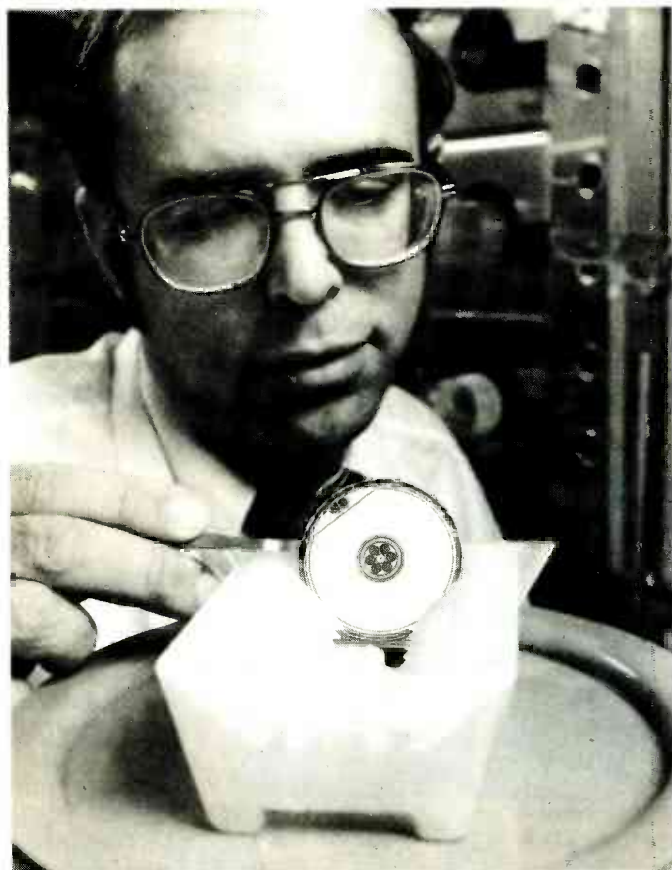

GE's NEW THYRISTOR, inspected here by Dr. Victor A.K. Temple, promises great reductions in high-voltage DC power-line costs. Through its innovative design, it can handle large currents while consuming little power itself, reducing the conversion losses of HVDC transmission systems. Work on the device, still in the early developmental stage, is being sponsored by the Electrical Power Research Institute, the research arm of the electric utility industry.



Accurate, Timely, Thorough . . .

## RCA 1982 TELEVISION SERVICE DATA

**Accurate** because it is prepared by service-experienced RCA Technical Publications editors who work closely with the engineers who design RCA Consumer Electronics products . . . **Timely** because it is promptly mailed (postpaid) directly to subscribers when the product is introduced . . . **Thorough** because it offers all of the following features that are essential for proficient servicing:

- **Easy-to-Trace Schematics**
- **Circuit Board Composite Views**
- **Chassis and/or Instrument Layout Diagrams**
- **Instrument Disassembly/Reassembly Instructions**
- **Service Adjustment Procedures**
- **Replacement Parts Lists**

- Complete coverage of all color and b/w TV Models Introduced in 1982
- TV Service Bulletins
- Ten-year RCA Service Data Index
- Saddlestitched format with drilled holes for easy insertion in optional three-ring binders



### And More . . .

Your yearly subscription to RCA TELEVISION SERVICE DATA includes:

- **Complete Service Data** for all color and b/w TV models introduced during 1982
- **Service Bulletins** that keep you abreast of the latest circuit changes, recommended servicing procedures, and parts information
- **Ten-Year RCA Service Data Index** that references RCA Service Data by both model and chassis, and includes RCA Warranty Obligation Codes and a separate listing of RCA Service Bulletins

- WITH TWO DURABLE VINYL-COVERED, THREE-RING BINDERS
- WITHOUT BINDERS

**Only \$56.85\***

**Only \$44.95\***

### \*INCLUDES RCA'S "PARTS INFORMATION SERVICE" . . .

Quarterly mailings from RCA Distributor & Special Products Division that give you replacement parts price schedules, Tuner - and Module-to-Chassis cross references, and other parts-related information that servicers and dealers have been asking for . . . making your 1982 RCA TELEVISION SERVICE DATA subscription an even bigger bargain.

## RCA FIELD-SERVICE GUIDE

Key field-service information from regular RCA Color TV service data . . . in a convenient, easy-to-use volume that covers two years of RCA Color TV models . . . complete chassis and tuner schematic diagrams and board views . . . chassis top and back views . . . field-service adjustments . . . parts lists . . . model index . . . troubleshooting tips . . . quick find indexes and cross references . . . each volume 17" X 11", Saddlestitched.

**VOLUME 8 (1979-1980)**  
RCA Color TV Chassis  
CTC 85, -86, -87, -88, -89,  
-90, -91, -92, -93, -96 -97,  
-99, -101

Only **\$12.95**

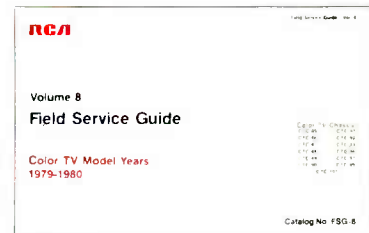

## 1982 RCA SERVICE DATA SUBSCRIPTION ORDER FORM

CHECK APPROPRIATE BOX/INDICATE QUANTITIES AND PRICE TOTALS/ENCLOSE CHECK

MAIL TO: **RCA TECHNICAL PUBLICATIONS 1-450**  
600 N. SHERMAN DRIVE  
INDIANAPOLIS, IN 46201



| 1982 SERVICE DATA SUBSCRIPTION                        | PRICE       | QUANTITY | PRICE TOTAL |
|---|-------------|----------|-------------|
| <input type="checkbox"/> TELEVISION, WITH TWO BINDERS | \$56.85 ea. | _____    | \$ _____    |
| <input type="checkbox"/> TELEVISION, WITHOUT BINDERS  | \$44.95 ea. | _____    | \$ _____    |
| <input type="checkbox"/> ADDITIONAL TV DATA BINDERS   | \$ 5.95 ea. | _____    | \$ _____    |
| <b>FIELD-SERVICE GUIDE</b>                            |             |          |             |
| <input type="checkbox"/> VOLUME 8                     | \$12.95 ea. | _____    | \$ _____    |

(Please Print)

NAME \_\_\_\_\_ TOTAL (AMOUNT OF YOUR CHECK\*) \$ \_\_\_\_\_

STREET ADDRESS \_\_\_\_\_

CITY \_\_\_\_\_ STATE \_\_\_\_\_ ZIP CODE \_\_\_\_\_

\*MAKE CHECK PAYABLE TO RCA CONSUMER ELECTRONICS

8203RE

MARCH 1982

# Choose your training!

# Only NRI gives you so many ways to get started on your TV/Video/Audio servicing career.

Only NRI gives you such a choice of practical experience projects with your training in servicing TV, video-cassette recorders and disc units, and audio systems. You can elect to build

NRI's 25" (diagonal) color TV with state-of-the-art fully-computerized programmable controls. Or, take your bench training on the latest model RCA programmable videocassette recorder

with exclusive videotaped lessons. Or concentrate on the world of audio as you work with a complete AM/FM stereo sound system. Any way you go, it's your choice... more choices than any other school.

**Train with this programmable RCA videocassette recorder**





## Each Course Complete

No matter which hands-on training program you select, your NRI course is complete. You get all 58 lessons covering every aspect of the field. TV, audio, and videocassette are just a start. You learn to install and service car radios and stereo systems... antenna systems including satellite TV... video disc players... cable TV... microprocessor controls and much more. NRI training is complete, thorough, and effective.

## Learn at Home in Your Spare Time

NRI trains you at home, at your convenience. No need to quit your job or tie up your evenings with night



Train as you assemble this fully-computerized, programmable 25" diagonal color TV

## Professional Instruments Included

You'll work with the famous NRI Discovery Lab<sup>®</sup>, where theory comes alive, exploring concepts and learning by doing. You'll use the Beckman LCD digital multimeter to read currents and resistances, keep it for professional troubleshooting. You'll build a CMOS digital frequency counter, another valuable servicing tool. And, depending on which experience project you choose, you'll also build your own 5" solid-state oscilloscope and a 10-function TV pattern generator. Use them for learning, use them for earning.

## NRI Picked by the Pros

A national survey of successful TV repairmen shows that

more than half had home-study training, and among them, it's NRI 3 to 1 over any other school. That's why, more than 67 years and a million and a quarter students later, NRI is still the leader. You can't beat the up-to-the-minute training for effectiveness and value. See how NRI can do it for you.

## Send for Free Catalog... No Salesman Will Call

Send today for our free, 100-page catalog which shows you all the kits and equipment you get, detailed lesson outlines, and convenient time payment plans. Or check out other fast-moving opportunity fields like Microcomputers & Microprocessors, Electronic Design Technology, Digital and Communications Electronics, and more. Mail the postage-paid card today and choose your training. If card has been removed, please write.

Learn by doing with NRI hands-on projects and professional instruments that you use and keep.

school pressures. NRI "fast-track" training makes learning easier... Action Audio Cassettes guide you step by step... NRI "hands-on" projects give you practical bench experience as you progress. You not only get theory, you actually build and test electronic circuits using professional equipment included with your course.



Train on this AM/FM stereo system complete with speakers



### NRI Schools

McGraw-Hill Continuing  
Education Center  
3939 Wisconsin Ave.  
Washington, D.C. 20016

We'll give you tomorrow.

# WHAT'S NEWS

continued from page 6

on demand, 24 hours a day.

News will be from local, regional, state, and national sources and will include sports, special events, business and financial news, and weather information.

Equipment used will be the TRS-80 Model II computer and the newly developed Communications Multiplexer.

According to Charles Phillips of Radio Shack, "We have not made a final decision on whether or not a subscription fee will be charged, but while much of the information will be free to the viewer, certain items will carry an access charge. We also plan to offer advertisers the opportunity to sponsor certain information pages."

The system will be offered to residents of the test area in early 1982.

## RCA's Satcom III relays cable TV

The third RCA communications satellite, Satcom III-R, launched last November into a geosynchronous orbit 23,000 miles above the equator, is intended to serve customers in the cable-TV industry. The 2,385-pound satellite was placed in position at 132 degrees West. It was the 11th U.S. domestic commercial satellite to go into orbit.

Like the earlier Satcoms, Satcom III-R has 24 transponders each of which can carry 1,400 voice circuits, one FM/color TV transmission, or 64 million bits

per second of computer data.

The Satcom satellites cover all 50 states and Puerto Rico. More than 4,000 earth stations, serving 14 million homes, have access to those spacecraft. Without the spacecraft, thousands of miles of ground cables and microwave links would be required to perform the same service.

Satcom III-R is powered by two solar array panels and three nickel-cadmium batteries. Maximum output is 950 watts at 35 volts (regulated) at the beginning of service and 750 watts at the end of the satellite's 10-year life. The batteries supply power during the two solar eclipse periods that take place each year.

## New high-current cell supplies 5-15 amperes

A new high-current lithium thionyl-chloride cell just announced by the Altus Corp of San Jose, CA, is capable of putting out 5 amperes continuously and up to 15 amperes in short pulses.

The new flat-disc cell, designated the AL250, has an open-circuit voltage of 3.5 volts, operates at temperatures from -40 to +70 degrees centigrade, and can stand prolonged storage at extreme temperatures without noticeable losses in capacity or response time. Its shelf life is estimated at more than 10 years.

The cell is said to be abso-



ALTUS AL250, 3.5-VOLT, 5-AMPERE CELLS

lutely safe under abusive conditions, such as incineration, crushing, or penetration.

## FCC urged to speed satellite TV licenses

The Satellite Television Corporation (STC), a subsidiary of COMSAT, has urged the FCC to process pending direct-broadcast satellite (DBS) applications on an individual basis.

Individual processing will "...eliminate the possibility that consideration of a few troublesome proposals would delay the issuance of authorizations to applicants whose DBS systems clearly will serve the public interest."

STC was the U.S. pioneer in proposing DBS service for the United States. If the FCC moves expeditiously to approve DBS applications in early 1982, STC will be able to initiate its DBS pay-TV service in late 1985, or early 1986.

STC has asked for FCC approval to offer a satellite-to-home subscription television service using DBS satellites. It would offer three channels of premium programming, without advertising. Individual subscribers would receive the scrambled signals using 2½-foot dish antennas.

## New message service between U.S. cities

RCA Network Services, an operating unit of RCA Communications, Inc., has filed an application with the FCC to construct and operate a nationwide digital electronic message-service (DEMS) among the nation's fifty major metropolitan areas.

The company believes that the first six areas—Atlanta, Chicago, Houston, Los Angeles, New York, and San Francisco—could be operational within 15 months of FCC approval and that the entire network could be in operation in seven years.

The DEMS network will provide high-speed, end-to-end private-line and switched services to the public. It is designed to handle digital bit-streams at rates ranging from 2.4 kilobits/second to 1.5 megabits/second, offering a flexible service to handle a wide variety of user applications: communicating word-processors, remote computer entry, high-speed facsimile, and videoconferencing.

RCA's proposed service will use satellite and microwave facilities for long-haul transmissions and the new Digital Transmission System (DTS) technology for transmission within cities.

R-E

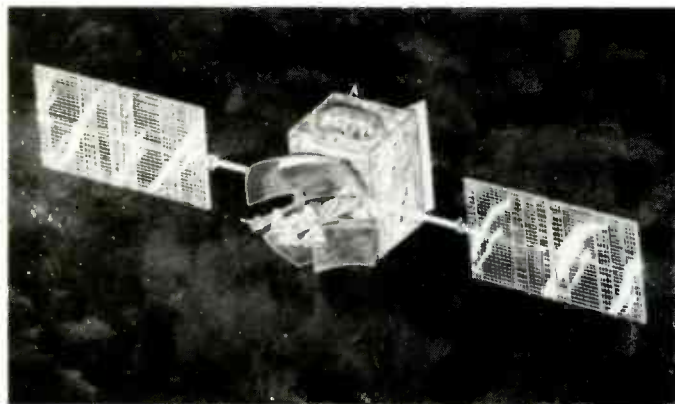

RCA's SATCOM III-R SATELLITE



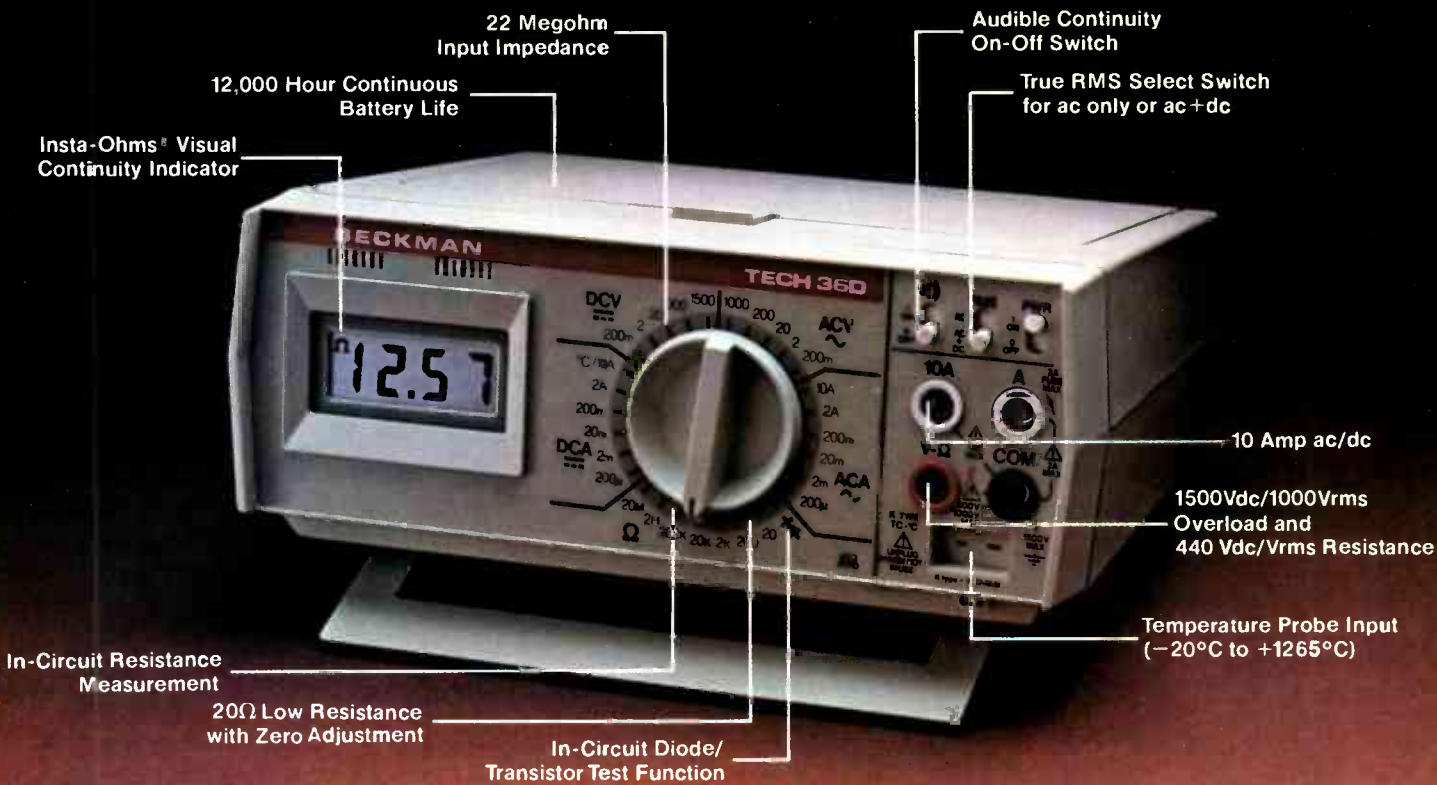

# Introducing the TECH™ 360 DMM. Never has it been so easy to do so much for so little.

Beckman's TECH 360 bench/portable DMM puts unmatched capability and convenience at your fingertips.

You can select from 8 functions and 31 ranges with one turn of the single selector switch.

On or off the bench, you can accurately measure all complex waveforms with True RMS AC functions. Extend resistance measurement to 1/100 ohm resolution. Read temperatures from  $-20^{\circ}\text{C}$  to  $1265^{\circ}\text{C}$ . Perform continuity checks

quickly, with audible and visible indications. Measure up to 10 amps without adding special adaptors. All with 0.1% basic Vdc accuracy.

## 12,000 hour battery life

Designed for ultimate ease of operation, the TECH 360 delivers 12,000 hours continuous service (up to 4 years of normal use) from standard heavy-duty batteries. You'll never have to search for power outlets or contend with ground loop errors. The expense of rechargeable battery packs is eliminated.

The TECH 360 is available for just \$289 (U.S. only), including batteries. The companion TECH 350 (without RMS and temperature measuring capability) is priced at \$229.

For information on the complete line of Beckman DMMs and accessories, call your local distributor today. For the one nearest you call: (714) 993-8803 or write Beckman Instruments, Inc., Electro-Products Group, 210 South Ranger Street, Brea, California 92621.



Convenient storage and multiple viewing angles are featured in the new line of Beckman bench/portable DMMs.

CIRCLE 46 ON FREE INFORMATION CARD

# BECKMAN

# Free

## HEATHKIT CATALOG

Discover the newest in electronics  
for your home and business...

- Computer hardware and software
- Earth Station
- Self-study educational courses
- Precision test instruments
- Computerized weather instruments
- Complete Solar Hot Water Systems
- Automotive and home energy savers
- Color TVs and video accessories
- Fine stereo high-fidelity components
- Amateur radio gear

...all in easy-to-build,  
money-saving kits.



Send for the all-new, free Heathkit Catalog today!

104 pages describe  
over 400 exciting  
kits for your  
electronics hobby.

If coupon is missing,  
write Heath Company,  
Department 020-852,  
Benton Harbor,  
MI 49022

Please send my free Heathkit Catalog.  
I am not currently receiving one.  
Mail to: **Heath Co., Dept. 020-872,**  
**Benton Harbor, MI 49022**

### free

Name \_\_\_\_\_

Address \_\_\_\_\_

City \_\_\_\_\_ State \_\_\_\_\_

CL-754 \_\_\_\_\_ Zip \_\_\_\_\_

CIRCLE 49 ON FREE INFORMATION CARD

## Radio- Electronics

Hugo Gernsback (1884-1967) founder  
**M. Harvey Gernsback**, editor-in-chief  
**Larry Steckler**, CET, publisher  
**Arthur Kleiman**, managing editor  
**Josef Bernard**, K2HUF, technical editor  
**Carl Laron**, WB2SLR, assistant editor  
**Jack Darr**, CET, service editor  
**Leonard Feldman**  
 contributing hi-fi/video editor  
**Robert F. Scott**, semiconductor editor  
**Herb Friedman**, communications editor  
**Gary H. Arlen**, contributing editor  
**David Lachenbruch**, contributing editor  
**Earl "Doc" Savage**, K4SDS, hobby editor  
**Ruby Yee**, production manager  
**Robert A. W. Lowndes**, production  
 associate  
**Joan Burwick**, production assistant  
**Joan Roman**, circulation director  
**Arline R. Fishman**,  
 advertising coordinator

Cover photo by Robert Lewis

**Radio-Electronics** is indexed in *Applied  
Science & Technology Index* and *Readers  
Guide to Periodical Literature*.

Gernsback Publications, Inc.  
200 Park Ave. S., New York, NY 10003  
President: M. Harvey Gernsback  
Vice President: Larry Steckler

**ADVERTISING SALES 212-777-6400**  
Larry Steckler  
Publisher

**EAST**  
Stanley Levitan  
Radio-Electronics  
200 Park Ave. South  
New York, NY 10003  
212-777-6400

**MIDWEST/Texas/Arkansas/Okla.**  
Ralph Bergen  
The Ralph Bergen Co., Inc.  
540 Frontage Road—Suite 325  
Northfield, Illinois 60093  
312-446-1444

**PACIFIC COAST  
Mountain States**  
Marvin Green  
Radio-Electronics  
413 So. La Brea Ave.  
Los Angeles, Ca 90036  
213-938-0166-7

**SOUTHEAST**  
Paul McGinnis  
Paul McGinnis Company  
60 East 42nd Street  
New York, N.Y. 10017  
212-490-1021

MPA





Facts from Fluke on low-cost DMM's

# For a measurement like this, every millivolt matters.

In digital multimeters, accuracy and resolution go hand in hand. After all, an extra millivolt of resolution means nothing unless you can trust its accuracy. For critical measurements like checking avionics, calibrating medical systems, or simply verifying the performance of your circuit, it takes a precision DMM to fill the bill.

The new 4½-digit Fluke 8050A delivers 0.03% basic dc accuracy and 0.005% of full scale resolution. Measure ac and dc voltages with 10 µV of sensitivity. Or resolve 10 nA of current and 1D milliohms of resistance. All guaranteed for one full year.

That's the kind of performance you demand in a

bench/portable DMM. And it's from Fluke, the leader in DMM's with a thirty year reputation for reliable, high-quality precision instrumentation.

Of course, there's more to the 8050A story. With our hybrid True RMS converter you get honest, accurate ac answers to 50 kHz without missing any significant distortion components. A dB function features 16 selectable reference impedances. And the relative mode lets you make offset measurements in all instrument functions.

You'll also find all the other dependable Fluke features on the new 8050A. Conductance for those high resistance and leakage measurements to 100,000 Megohms. Extensive overload protection and safety features. A full line of accessories. And a low price of only \$369 U.S.

For all the facts on the new 8050A's accuracy and reliability, call toll free 800-426-0361; use the coupon below; or contact your Fluke stocking distributor, sales office or representative.

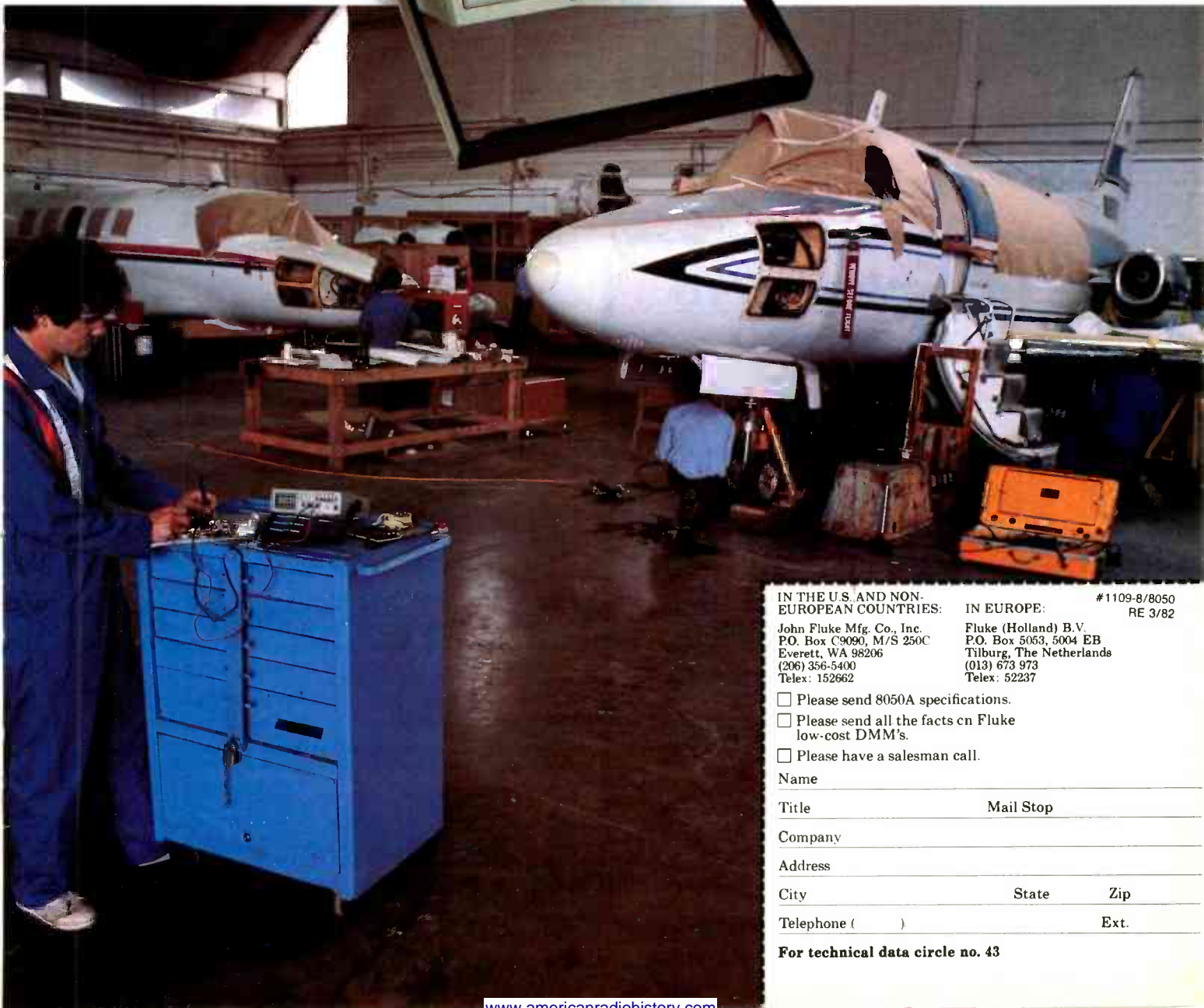

IN THE U.S. AND NON-EUROPEAN COUNTRIES: #1109-8/8050  
RE 3/82

John Fluke Mfg. Co., Inc.  
P.O. Box C9090, M/S 250C  
Everett, WA 98206  
(206) 356-5400  
Telex: 152662

IN EUROPE:  
Fluke (Holland) B.V.  
P.O. Box 5053, 5004 EB  
Tilburg, The Netherlands  
(013) 673 973  
Telex: 52237

- Please send 8050A specifications.
- Please send all the facts on Fluke low-cost DMM's.
- Please have a salesman call.

Name \_\_\_\_\_

Title \_\_\_\_\_

Mail Stop \_\_\_\_\_

Company \_\_\_\_\_

Address \_\_\_\_\_

City \_\_\_\_\_

State \_\_\_\_\_

Zip \_\_\_\_\_

Telephone ( ) \_\_\_\_\_

Ext. \_\_\_\_\_

For technical data circle no. 43

# PROTEUS I™ a lead synthesizer that has it all!



You've always had a lot of options.

You could have the convenience and easy operation of a normalized synthesizer if you were willing to give up the versatility of modular equipment.

Or the unlimited spectrum of tone colors and timbres of modules if you didn't mind the cumbersome patch cords and time required to set up or change a patch.

You could have programmable presets if you could raise the bucks, or low-cost equipment if you could stand the snap-crackle-pop.

You could even have such technically innovative features as computer control of voice and sequence if you had the technical savvy to design it all and make it work.

Now you have another option YOU CAN HAVE IT ALL. Wide range, precise, low-noise, presets, meaningful patch bay and an easy-to-use computer interface.

All at a price that's nothing but unbelievable.

Want to know more? Proteus I's Using/Assembly manual which includes a demo tape will answer all of your questions. The price, \$10.00 is refundable upon purchase of the kit.

PART OF THE NEW GENERATION FROM

**PAIA Electronics, Inc.**

1020 W. Wilshire, Oklahoma City, OK 73116 (405)843-9626

CHARGE ORDER? Call our 24 hour Demo/Order line

405-843-7396

- Send the easy-to-assemble Proteus I Kit, \$499.00 enclosed. (Freight Collect)
- Tell me more. Rush the Assembly/Using manual & demo tape for Proteus I. (\$10.00 enclosed, refundable)
- Send free catalog

Name: \_\_\_\_\_

Address: \_\_\_\_\_

City: \_\_\_\_\_ State: \_\_\_\_\_ Zip: \_\_\_\_\_

Visa \_\_\_\_\_ MC \_\_\_\_\_ Card No. \_\_\_\_\_

PAIA Electronics, Dept. 3R, 1020 W. Wilshire, Okla. City, OK 73116

CIRCLE 80 ON FREE INFORMATION CARD

# LETTERS

## UNICORN-1 ROBOT

I was impressed by the very thorough series of articles, "Unicorn-1 Robot," that appeared in **Radio-Electronics**, August 1980 through June 1981. However, there appear to be a few errors that should be noted.

In the March 1981 issue (page 65), the relay driver circuit will not work as explained in the text. As shown, the 2N2222 transistor and relay will be turned on in absence of a command. That is opposite the condition that is desired. In other words, what is required at the transistor base is a logic-low to de-energize the relay in the stand-by mode.

There are a couple of modifications that can be made without altering the printed-circuit boards. The choices are:

Latch Board: take the output signal from the Q pins 6 and 8, or:

Relay Driver Board: drive the transistor directly from the decoder board or latch board by eliminating the octal inverter

(2813A) and placing jumper wire between input and output pins of the IC socket.

The suggestion to use PNP transistors is not recommended because that places 5-volts across the base-emitter junction and the driver in series; that could damage the transistor.

In the April 1981 issue (page 68), Fig. 80, and (page 69), Fig. 82, the latch board input and output signals on pins 9 and 11 of the 7474 IC are reversed.

WALTER PALANKER,  
Magnolia, NJ

## PROGRAMMING FLAW

I am the proud owner of a new personal computer system, and because of that, your October 1981 issue of **Radio-Electronics** caught my eye. I got a lot out of that issue!

I did a lot of shopping around before I decided on the TRS-80, 16K, color outfit. Along with it, I purchased some software

*continued on page 22*

# For truly superb FM-stereo reception...

The **G.A.M. Stereo One** vertical antenna

- Transforms fuzzy stations into 'tape quality'
- Reduces multipath problems
- Up to twice the power of the conventional dipole antenna
- Receives from all directions
- Pulls in stations you never knew existed
- Sturdy, stainless steel and PVC construction
- Silver plated brass joints for ultra-sensitive signal passage
- Built to withstand weather stands just 76" tall
- May be mounted on a mast, windowsill, balcony, or just stand it in the corner

Test it yourself! We offer an honest-to-goodness 30 day MONEY-BACK guarantee. If it doesn't measure up to your standards, send it back for a refund of the purchase price.

The suggested list price for Stereo One is \$69.95

BUY DIRECT AND SAVE \$10.00

Send your check or money order for \$59.95 + 3.50 (shipping and handling) to: (N.Y. residents, please add 7% sales tax)

VISA & MASTER CARD buyers may call toll free 1-800-448-8490 9-5 EST Mon-Fri  
N.Y. Residents please call 1-315-482-2589



**Castle Marketing**

Dept. RE  
Holland Street  
P.O. Box 219  
Alexandria Bay,  
New York 13607

CIRCLE 58 ON FREE INFORMATION CARD

# PRINTED CIRCUIT KITS MAKE CARDS QUICKLY



ONLY Vector kits contain:

- Positive photo-resist coated AND uncoated copper laminate—no messy photo-reversal—no spraying, dipping, or baking.
- 4 types of art aids: rub transfers, ink, tape, cut and peel—use 1 or all.
- 1:1 circuit art rub transfers—IC sets, pads, lines, connectors, symbols, letters, and numbers.
- Everything included—just add water and sunlamp or bright sunshine.
- Liquid etchant and developer—no dry chemical mixing problems.
- Process choices—make circuit on copper and etch for 1 card. Make circuit on film, expose, develop and etch for 1 or many cards.

ART AIDS + mylar film + sunlamp cards + developer & etchant = 1 or many PC's  
+ card + etchant = 1PC

32X-A-1 kit makes 7 PC cards, \$46.41, 32X-1 starter kit makes 2 cards, \$18.24  
If not available locally, factory order include \$3.00 shipping, U.S. only  
Prices subject to change without notice

510177

Vector Electronic Co., 12460 Gladstone Av., Sylmar, CA 91342

CIRCLE 57 ON FREE INFORMATION CARD



# More ways to C the value... with B&K-PRECISION

Now you can choose the capacitance measurement instrument you need from the industry's most complete line. For high-speed sorting, there's the 835 Digital Capacitance Comparator; and for less specialized applications, the 830 Autoranging C-Meter and the 820 Manual Ranging C-Meter. All are GSA listed.

The 835 is a rugged production tool for isolating out-of-tolerance capacitors in the shortest possible time. Program-in acceptable high and low capacitance limits and then start testing. The 835 indicates "LO," "GOOD" or "HI." It also indicates capacitance values on an autoranging C-meter.

Combining autoranging and portability, the B&K-PRECISION 830 C-meter offers features that are tough to match at any price. Resolution is 0.1 pF, with readings

displayed on a large 3-1/2-digit LCD display. Basic accuracy is 0.2%, much greater than the tolerance of most capacitors. Ease of operation is another strength of the 830. Even untrained workers can quickly learn its operation, though its performance also makes it ideal for engineering lab use. A selectable "range hold" is also featured.

For field or bench applications suited to manual ranging, B&K-PRECISION offers the 820—the industry's best C-meter value. The 820 displays readings to a full 1 Farad on a 4-digit LED display. Accuracy is within 0.5%.

All of the B&K-PRECISION C-measurement products are protected against charged capacitors. They all

also allow you to measure unmarked capacitors, verify capacitor tolerance, measure cable capacitance, select and match capacitors for critical applications, perform quality assurance, measure complex networks, set trimmer capacitors and check capacitance in switches and other components. Options include the CF-10 test fixture for volume sorting; and for the 830 and 820, rechargeable batteries, AC charger and carrying case.

For immediate delivery or more details, see your local distributor, and see why B&K-PRECISION continues to be the leading supplier of digital capacitance measurement instruments. For the name of your nearest distributor call toll-free 800-621-4627.

**B&K PRECISION** DYNASCAN CORPORATION

6460 W. Cortland Street • Chicago, IL 60635 • 312/889-9087

International Sales, 6460 W. Cortland Street, Chicago, IL 60635 USA; TELEX: 25-3475

Canadian Sales, Atlas Electronics, Ontario



Model 820 \$185  
Model 830 \$229  
Model 835 \$675

CIRCLE 41 ON FREE INFORMATION CARD

**Learning  
electronics  
is no picnic.**

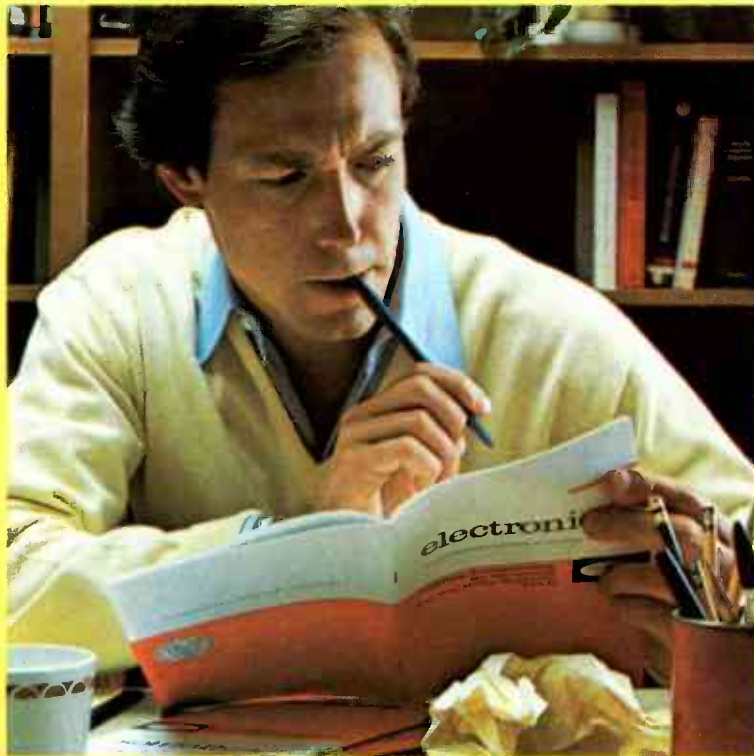

**At any level it  
takes work and  
a few sacrifices.  
But with CIE,  
it's worth it.**



Whoever said, "The best things in life are free," was writing a song, not living a life. Life is not just a bowl of cherries, and we all know it.

You fight for what you get. You get what you fight for. If you want a thorough, practical, working knowledge of electronics, come to CIE.

You can learn electronics at home by spending just 12 hard-working hours a week, two hours a day. Or, would you rather go bowling? Your success is up to you.

At CIE, you *earn* your diploma. It is not handed to you simply for putting in hours. But the hours you do put in will be on your schedule, not ours. You don't have to go to a classroom. The classroom comes to you.

### Why electronics training?

Today the world depends on technology. And the "brain" of technology is electronics. Every year, companies the world over are finding new ways to apply the wonders of electronics to control and program manufacturing, processing...even to create new leisure-time products and services. And the more electronics applications there are, the greater the need will be for trained technicians to keep sophisticated equipment finely tuned and operating efficiently. That means career opportunities in the eighties and beyond.

### Which CIE training fits you?

Beginner? Intermediate? Advanced? CIE home study courses are designed for ambitious people at all entry levels. People who may have:

1. No previous electronics knowledge, but do have an interest in it;
2. Some basic knowledge or experience in electronics;
3. In-depth working experience or prior training in electronics.

You can start where you fit and fit where you start, then go on from there to your Diploma, FCC License and career.

### Many people can be taught electronics.

There is no mystery to learning electronics. At CIE you simply start with what you know and build on it to develop the knowledge and techniques that make you a specialist. Thousands of CIE graduates have learned to master the simple principles of electronics and operate or maintain even the most sophisticated electronics equipment.

### CIE specializes exclusively in electronics.

Why CIE? CIE is the largest independent home study school that specializes exclusively in electronics. Nothing else. CIE has the electronics course that's right for you.

Learning electronics is a lot more than memorizing a laundry list of

facts about circuits and transistors. Electronics is interesting! It is based on recent developments in the industry. It's built on ideas. So, look for a program that starts with ideas and builds on them. Look to CIE.

### Programmed learning.

That's exactly what happens with CIE's Auto-Programmed® Lessons. Each lesson uses famous "programmed learning" methods to teach you important principles. You explore them, master them completely, before you start to apply them. You thoroughly understand each step before you go on to the next. You learn at your own pace.

And, beyond theory, some courses come fully equipped with electronics gear (the things you see in technical magazines) to actually let you perform hundreds of checking, testing, and analyzing projects.

### Experienced specialists work closely with you.

Even though you study at home, you are not alone! Each time you return a completed lesson, you can be sure it will be reviewed, graded and returned with appropriate instructional help. When you need additional individual help, you get it fast and in writing from the faculty technical specialist best qualified to

answer your question in terms you can understand.

### CIE prepares you for your FCC License.

For some jobs in electronics, you must have a Federal Communications Commission (FCC) License. For others, some employers tend to consider your license a mark in your favor. Either way, your license is government-certified proof of your knowledge and skills. It sets you apart from the crowd.

More than half of CIE's courses prepare you to pass the government-administered exam. In continuing surveys, nearly 4 out of 5 graduates who take the exam get their licenses! You can be among the winners.

### Associate Degree

Now, CIE offers an Associate in Applied Science Degree in Electronics Engineering Technology. In fact, all or most of every CIE Career Course is directly creditable towards the Associate Degree.

### Today is the day. Send now.

Fill in and return the postage-free card attached. If some other ambitious person has removed it, cut out and mail the coupon. You'll get a FREE school catalog plus complete information on independent home study. For your convenience, we'll try to have a CIE representative contact you to answer any questions you may have.

Mail the card or the coupon or write CIE (mentioning name and date of this magazine) at: 1776 East 17th Street, Cleveland, Ohio 44114.



Pattern shown on oscilloscope screen is simulated.

## CIE Cleveland Institute of Electronics, Inc.

1776 East 17th Street, Cleveland, Ohio 44114

Accredited Member National Home Study Council

**YES...** I want to learn from the specialists in electronics — CIE. Send me my FREE CIE school catalog...including details about the Associate Degree program...plus my FREE package of home study information.

Print Name \_\_\_\_\_

Address \_\_\_\_\_ Apt. \_\_\_\_\_

City \_\_\_\_\_

State \_\_\_\_\_ Zip \_\_\_\_\_

Age \_\_\_\_\_ Phone (area code) \_\_\_\_\_

Check box for G.I. Bill bulletin on Educational Benefits:  Veteran  Active Duty

**MAIL TODAY!**

RE--33

## LETTERS

continued from page 16

which included the "Computer Learning Lab." When I ran that particular program I discovered what I thought to be a major flaw in programming. That error was verified by my local dealer. I wrote to Tandy at the address listed in your magazine. That was over a month ago, and I thought that you might be interested to learn that no one has had the decency to acknowledge either the probable software problem or my letter.

Naturally, my impression is that the sales for Tandy stop short of customer service.

Thank you for your attention and for a truly informative magazine.  
MRS. WENDY C. LOOMIS,  
Binghamton, NY

Dear Mrs. Loomis:

Thank you for purchasing a Color Computer from Radio Shack. I am distressed to hear that you discovered a programming bug, notified Radio Shack, and that no one has gotten back to you to solve or confirm your problem.

Not having seen a copy of the article in the October 1981 issue of *Radio-Electronics* to which you referred, and not knowing which address you were told to write to, I cannot comment on why there has been no response to your problem.

The only programming error which we have found since releasing the "Color Computer Learning Lab" is in the chapter covering Sorts (Lesson 14). The sort routine, as shown in the manual and on the tape, will not sort the last value. Changing line 230 as follows will fix the problem:

230 FOR B = A+1 TO N.

That change should be made on pages 93 and 98 of your manual and to the program tape. Our customer-service group has this correction, and should have sent it to you. Any further problems concerning the Color Computer or the software for the Color machine should be sent to: TRS-80 Customer Service, 400 Atrium, One Tandy Center, Ft. Worth, TX 76102.

You should include a phone number where possible, as sometimes it is quicker to call with the information or answer.

Radio Shack believes very strongly in support after sale. I am truly sorry for any inconvenience we may have caused you. Be assured that we will make every effort to assure that it does not happen again.

BARRY O. THOMPSON,  
Product Line Manager—Color Computer

### VHS DECKS

Your magazine and several others continually state that Akai has the only VHS decks with stereo sound. That isn't so; we have several Panasonic NV-8200 VHS decks, as well as some Sony Beta SLO-323 decks, both of which have two-channel audio, and have been giving us excellent service, since we put them into use last summer.

Also, with the increased interest in getting the best audio/video performance from one's own equipment, it might be interesting to your readers if you could come up with a circuit to add video and audio input jacks safely to existing receivers that lack this capability.

JIM CASSEDY,  
Production Technician, Alcon Video/  
Film Prods.,  
San Francisco, CA

### CX DECODER

There are a couple of small corrections to be made to the first part of the "CX Decoder" article, appearing in the December 1981 *Radio-Electronics*.

On page 46, the last sentence in the first paragraph of column 3 should read: "That higher bias also results in a higher gain in the peak mode than in the CX mode when expansion is not taking place." On the schematic, the value of R29 was left out; that should be 1K. I'm sure that I confused the draftsman, because my schematic shows pin 11 of IC4 connected both to -15 volts and ground. In any case, pin 11 of IC4 should go to ground, and not to -15 volts.

We will pack an errata slip with each kit-part order to catch those three points. The only other potential problem that I noted is that the print of the PC board seems to have blurred lightly, and you may get complains of shorting between adjacent conductors, because the board is so tightly laid out.

Aside from that, I am delighted with the article.

JOEL M. COHEN

R-E

# YOU'LL NEVER OUTGROW THE HOBBY-BLOX™ MODULAR CIRCUIT BUILDING SYSTEM

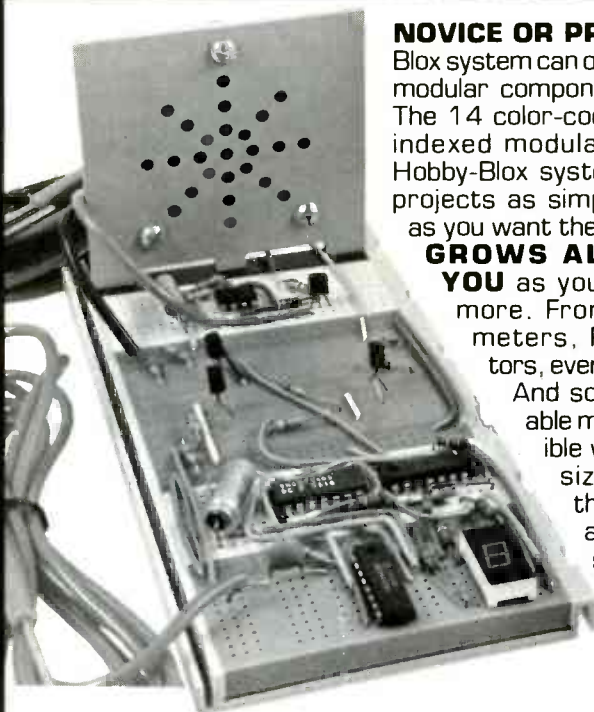

**NOVICE OR PRO**, the Hobby-Blox system can offer you exciting modular component challenges. The 14 color-coded and cross-indexed modular units in the Hobby-Blox system can create projects as simple or complex as you want them to be.

**GROWS ALONG WITH YOU** as you learn and do more. From Digital Voltmeters, Pulse Generators, even Slot Machines.

And solderless, reusable modules compatible with DIP's of all sizes make even the most elaborate systems a snap.

Patents Pending.  
© A P PRODUCTS  
INCORPORATED 1980.

**FREE CATALOG** and the name of your nearest Hobby-Blox dealer — call toll-free [800] 321-9668. In Ohio, call collect [216] 354-2101.



A P PRODUCTS INCORPORATED  
9450 Pineneedle Drive  
P.O. Box 603  
Mentor, Ohio 44060  
[216] 354-2101  
TWX: 810-425-2250

In Europe, contact A P PRODUCTS GmbH  
Baumlesweg 21 • D-7031 Weil 1 • W. Germany



# SATELLITE/TELETEXT NEWS

GARY ARLEN  
CONTRIBUTING EDITOR

## AUCTION SELLS TRANSPONDERS

In an unusual effort to allocate transponders aboard Satcom IV (which was due to go up in January), RCA Americom—which operates the satellite—sponsored an auction at swanky Sotheby Parke Bernet gallery in New York, better known for selling expensive art items. When the 45-minute action was over, six companies had paid a total of \$90.1 million for the seven transponders which were being offered. The highest bid was \$14.4 million, offered by "Transponder Leasing Co." That bought transponder two, probably for future voice and data communications services. Some names were familiar, and all of them paid more than \$10.7 million per transponder. Among them were Home Box Office, which will operate on transponder 15; RCTV, the new service offering "The Entertainment Channel" of cultural and theatrical performances, which purchased transponder 11; Warner Amex Satellite will use transponder four; UTV Cable Network, a new entertainment and merchandising service, will have transponder 23; Inner City Broadcasting will go on transponder 16, and Bill Batts, an individual representing a Tennessee religious broadcasting group, will transmit on transponder three.

All of those allocations are in addition to the previous commitments—including some video as well as data services—which were already set for the new bird.

Meanwhile, some of the new Satcom IV residents are expanding their other transponder activities. HBO, of course, is well ensconced on several other current and future birds. RCTV recently entered into an agreement with Spanish International Network, which would give RCTV use of another Satcom IV transponder.

## THE FCC'S TELETEXT NON-STANDARD

In keeping with official Washington's policy of "deregulation," the FCC has decided not to establish a formal teletext technical standard for the U.S., choosing instead to let the "marketplace" decide which format should be used. That means that competing French, British, and Canadian technologies will have to fight it out to win allies who will use their respective technologies on U.S. television stations. CBS says that it intends to begin transmitting teletext nationally during 1982; that could encourage its affiliates to adopt the French Antiope format, which CBS favors. Meanwhile, others are beginning to use other formats; for example, WKRC-TV Channel 12 in Cincinnati is planning to test the British Prestel format.

Although it won't adopt formal teletext standards, the FCC is currently considering a number of related technical issues. The Commission will consider the possibility of permitting teletext to be transmitted via lines 14 through 18, plus lines 20 and 21 of the vertical blanking-interval. The FCC is also considering possible future use of lines 10-13, using a phased-in schedule, once it is confirmed that those lines won't cause visual degradation of regular video images on TV receivers.

## AROUND THE SATELLITE CIRCUIT

The continuing scramble skyward by several leading program suppliers promises to offer ever-more attractive shows during the coming year. Among the newest entries is "The Disney Channel," a service due to get under way early next year (1983). It will use two transponders aboard Westar V, which will be launched this fall. Walt Disney Productions and Westinghouse Broadcasting are cooperating to develop the 16-hour-per-day channel of pay-cable programming.

**American Satellite Co.** will provide all-digital satellite transmission for the Home Music Store, a new home-recording service offered by Digital Music Co. The electronic feed, due to get under way in July (1982) will provide cable-TV subscribers with master-tape-quality digital music for listening and licensed recording. Cable subscribers will need a special decoder to input the high-quality audio feed into their tape recorders. Music will be uplinked from Los Angeles to ASC's Westar transponders.

**Comsat has proposed** to provide the first full-time satellite TV service from the U.S. to an overseas location. The new service, due to begin in Fall 1982, will permit continuous video transmission from the U.S. to Australia, where it will be used by that nation's Channel 9. Comsat officials say that the type of international feed, which will be uplinked from a new facility in Southern California and travel via a Pacific Intelsat bird, is the forerunner of a "new kind of international TV service which will develop in the next few years."

R-E

# The \$149<sup>95</sup> personal computer.

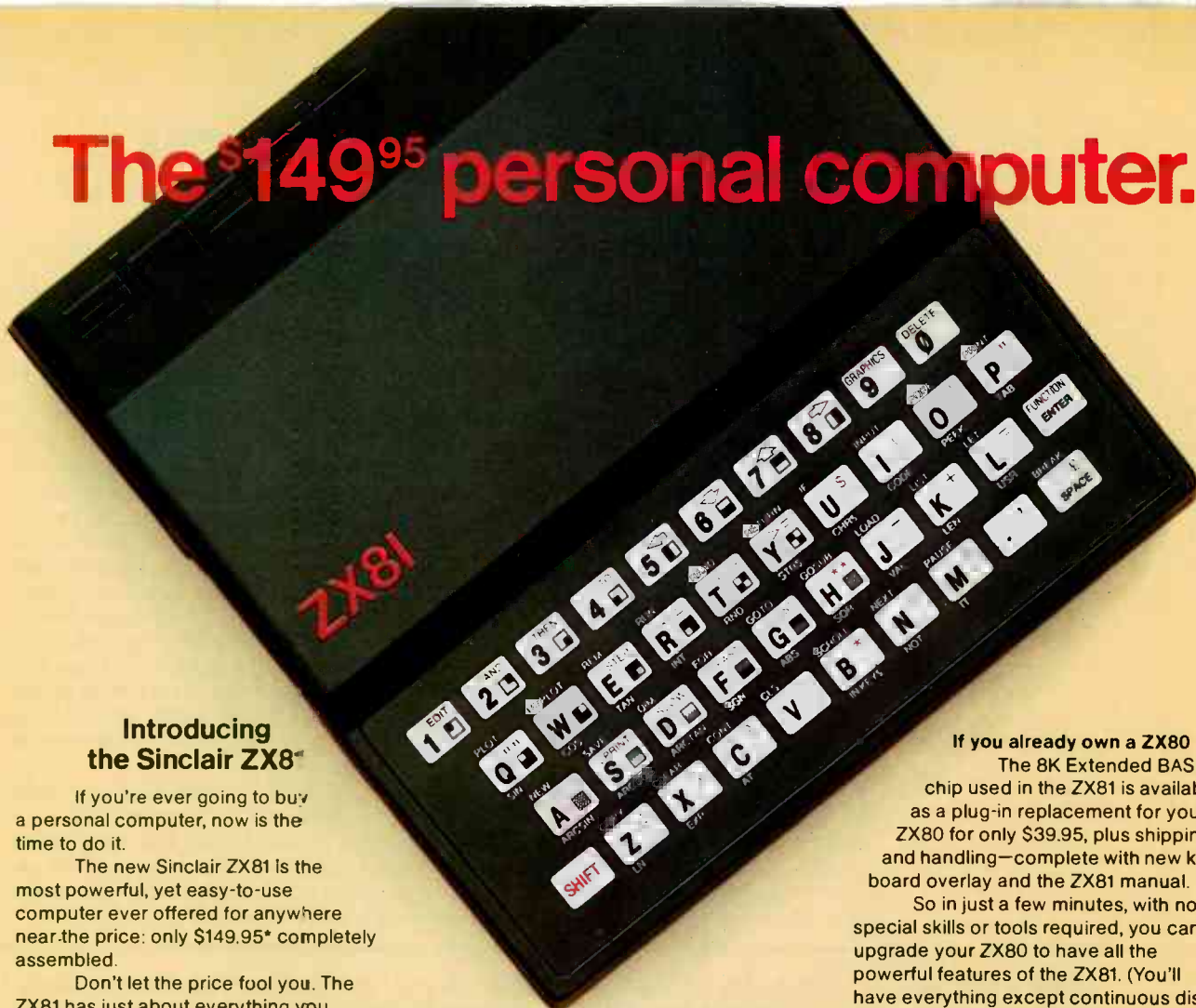

## Introducing the Sinclair ZX81\*

If you're ever going to buy a personal computer, now is the time to do it.

The new Sinclair ZX81 is the most powerful, yet easy-to-use computer ever offered for anywhere near the price: only \$149.95\* completely assembled.

Don't let the price fool you. The ZX81 has just about everything you could ask for in a personal computer.

### A breakthrough in personal computers

The ZX81 is a major advance over the original Sinclair ZX80—the world's largest selling personal computer and the first for under \$200.

In fact, the ZX81's new 8K Extended BASIC offers features found only on computers costing two or three times as much.

Just look at what you get:

- Continuous display, including moving graphics
- Multi-dimensional string and numerical arrays

\* Plus shipping and handling. Price includes connectors for TV and cassette, AC adaptor, and FREE manual.

- Mathematical and scientific functions accurate to 8 decimal places
- Unique one-touch entry of key words like PRINT, RUN and LIST
- Automatic syntax error detection and easy editing
- Randomize function useful for both games and serious applications
- Built-in interface for ZX Printer
- 1K of memory expandable to 16K

The ZX81 is also very convenient to use. It hooks up to any television set to produce a clear 32-column by 24-line display. And you can use a regular cassette recorder to store and recall programs by name.

## If you already own a ZX80

The 8K Extended BASIC chip used in the ZX81 is available as a plug-in replacement for your ZX80 for only \$39.95, plus shipping and handling—complete with new keyboard overlay and the ZX81 manual.

So in just a few minutes, with no special skills or tools required, you can upgrade your ZX80 to have all the powerful features of the ZX81. (You'll have everything except continuous display, but you can still use the PAUSE and SCROLL commands to get moving graphics.)

With the 8K BASIC chip, your ZX80 will also be equipped to use the ZX Printer and Sinclair software.

### Order at no risk\*\*

We'll give you 10 days to try out the ZX81. If you're not completely satisfied, just return it to Sinclair Research and we'll give you a full refund.

And if you have a problem with your ZX81, send it to Sinclair Research within 90 days and we'll repair or replace it at no charge.

\*\*Does not apply to ZX81 kits.

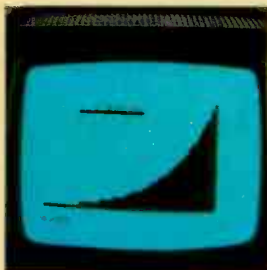

**NEW SOFTWARE:** Sinclair has published pre-recorded programs on cassettes for your ZX81, or ZX80 with 8K BASIC. We're constantly coming out with new programs, so we'll send you our latest software catalog with your computer.



**ZX PRINTER:** The Sinclair ZX Printer will work with your ZX81, or ZX80 with 8K BASIC. It will be available in the near future and will cost less than \$100.



**16K MEMORY MODULE:** Like any powerful, full fledged computer, the ZX81 is expandable. Sinclair's 16K memory module plugs right onto the back of your ZX81 (or ZX80, with or without 8K BASIC). Cost is \$99.95, plus shipping and handling.



**ZX81 MANUAL:** The ZX81 comes with a comprehensive 164-page programming guide and operating manual designed for both beginners and experienced computer users. A \$10.95 value, it's yours free with the ZX81.



# The \$99<sup>95</sup> personal computer.

## Introducing the ZX81 kit

If you really want to save money, and you enjoy building electronic kits, you can order the ZX81 in kit form for the incredible price of just \$99.95\*. It's the same, full-featured computer, only you put it together yourself. We'll send complete, easy-to-follow instructions on how you can assemble your ZX81 in just a few hours. All you have to supply is the soldering iron.

### How to order

Sinclair Research is the world's largest manufacturer of personal computers.

The ZX81 represents the latest technology in microelectronics, and it picks up right where the ZX80 left off. Thousands are selling every week.

We urge you to place your order for the new ZX81 today. The sooner you order, the sooner you can start enjoying your own computer.

To order, simply call our toll free number, and use your MasterCard or VISA.

To order by mail, please use the coupon. And send your check or money order. We regret that we cannot accept purchase orders or C.O.D.'s.

**CALL 800-543-3000.** Ask for operator #509. In Ohio call 800-582-1364. In Canada call 513-729-4300. Ask for operator #509. Phones open 24 hours a day, 7 days a week. Have your MasterCard or VISA ready.

These numbers are for orders only. For information, you must write to Sinclair Research Ltd., 2 Sinclair Plaza, Nashua, NH 03061.

# sinclair

| AD CODE 03RE                         | PRICE†   | QTY. | AMOUNT |
|--------------------------------------|----------|------|--------|
| ZX81                                 | \$149.95 |      |        |
| ZX81 Kit                             | 99.95    |      |        |
| 8K BASIC chip (for ZX80)             | 39.95    |      |        |
| 16K Memory Module (for ZX81 or ZX80) | 99.95    |      |        |
| Shipping and Handling                | 4.95     |      | \$4.95 |
| TOTAL                                |          |      |        |

MAIL TO: Sinclair Research Ltd., One Sinclair Plaza, Nashua, NH 03061.

NAME \_\_\_\_\_

ADDRESS \_\_\_\_\_

CITY/STATE/ZIP \_\_\_\_\_

† U.S. Dollars

# Remove Vocals

Remove the lead vocal and substitute your own voice with most stereo recordings using our new, low cost VOCAL ZAPPER™. Great for practice, professional demos or just for fun.

WITH THE

**VOCAL ZAPPER™**



FROM

**PAIA Electronics, Inc.**

1020 W. Wilshire, Oklahoma City, OK 73116 • (405)843-9626

- Rush my Vocal Zapper Kit, \$24.95 plus \$3 postage & handling enclosed.
- Send assembled Vocal Zapper, \$39.95 plus \$3 postage & handling enclosed.
- Send Free Catalog

name \_\_\_\_\_

address \_\_\_\_\_

city \_\_\_\_\_ state \_\_\_\_\_ zip \_\_\_\_\_

Visa  MC  card no. \_\_\_\_\_

PAIA Electronics, Dept. 3R, 1020 W. Wilshire, Okla. City, OK 73116

**CIRCLE 81 ON FREE INFORMATION CARD**

# EQUIPMENT REPORTS

## Realistic PRO-2020 Programmable Scanner



**CIRCLE 101 ON FREE INFORMATION CARD**

THE INCREASING AVAILABILITY OF FREQUENCY-SYNTHESIZED SCANNERS HAS BEEN A BOON TO LISTENING ENTHUSIASTS. ONE OF THE NEWEST SCANNERS IS THE REALISTIC PRO-2020 PROGRAMMABLE AM/FM

| Realistic          | PRO2020 |   |      |   |   |      |   |   |           |    |
|--------------------|---------|---|------|---|---|------|---|---|-----------|----|
| OVERALL PRICE      |         |   |      |   |   |      |   |   |           |    |
| EASE OF USE        |         |   |      |   |   |      |   |   |           |    |
| INSTRUCTION MANUAL |         |   |      |   |   |      |   |   |           |    |
| PRICE/VALUE        |         |   |      |   |   |      |   |   |           |    |
|                    | 1       | 2 | 3    | 4 | 5 | 6    | 7 | 8 | 9         | 10 |
|                    | Poor    |   | Fair |   |   | Good |   |   | Excellent |    |

scanner from Radio Shack (One Tandy Center, Fort Worth, TX 76102). Covering 30-50, 108-136, 138-174, and 410-512 MHz, it has one of the widest tun-  
*continued on page 34*

"In Just A Few Days, I'll Show You How To Do

# REAL MATH

On Your Calculator!"

$$\int_a^b f \sum_{n=1}^{\infty} a_n \frac{df}{dx} \lim_{n \rightarrow \infty}$$

- Quick. •Guaranteed.
- Easy. •Fun, Too!



**INTRIGUED BY CALCULATORS?** Then you can step up your math skills *fast!* Use my *new method* in guidebook form. It's called **CALCULATOR CALCULUS**. This space-travel spinoff is sure-fire, so it has a **simple guarantee** — just return it for an **immediate refund** if you are **not astounded** at the problems you're solving with it!

But the point is - you won't want to send it back. For this is the **easiest, fastest shortcut** ever! The day you receive your copy in the mail you'll want to put it to work. It's that exciting and helpful.

My name is Dr. George McCarty. I teach math at the University of California. I wrote this guidebook to cut through the confusion. I guide you with **examples** you follow step-by-step on your calculator — you do simple **exercises** — then you solve practical problems with real precision!

**POWER METHODS.** Need to evaluate functions, areas, volumes — solve equations — use curves, trig, polar coordinates — find limits for sequences and series? It's all here!

If you're in the biological, social or physical sciences, you'll be doing Bessel functions, carbon dating, Gompertz growth curves, half-life, future value, marginal costs, motion, cooling, probability, pressure — and plenty more (even differential equations).

Important numerical techniques? Those algorithms are here, too: rational and Padé approximation, bracketing, continued fractions, Euler's method, Heun's method, iteration functions, Newton's method, predictor-corrector, successive substitutions, Simpson's method and synthetic division.

**LOOK AT WHAT USERS SAY:** Samuel C. McCluney, Jr., of Philadelphia writes:

"**CALCULATOR CALCULUS IS GREAT!** For ten years I have been trying to get the theory of calculus through my head, using home-study courses. It was not until I had your book that it became clear what the calculus was all about. Now I can go through the other books and see what they are trying to do. With your book and a calculator the whole idea becomes clear in a moment, and is a MOST REFRESHING EXPERIENCE. I program some of the iterative prob-

lems you suggest and it always **GIVES ME A THRILL** to see it start out with a wild guess and then approach the limit and stop."

Professor John A. Ball of Harvard College (author of the book *Algorithms for RPN Calculators*) writes: "I wish I had had as good a calculus course."

Professor H. I. Freedman of the U. of Alberta, writing in *Soc. Ind. Appl. Math Review*, states:

"There can be no question as to the usefulness of this book...lots of exercises...very clearly written and makes for easy reading."

Tektronix Engineer Bill Templeton says "**CALCULATOR CALCULUS is the best, most clearly written book I have seen for improving your math skills.**"

**I WANT YOU TO DO THIS.** Get my complete kit, with a TI-35 calculator, plus its 200 p. Student Math Book, **AND** the guidebook, **ALL** for \$44.95 (for shipping to USA add \$2, or \$5 by AIR; Foreign \$5, or \$10 AIR; in Calif. add \$2.70 tax).

If you already have a scientific calculator, you can invest in the guidebook, **CALCULATOR CALCULUS**, for only U.S. \$19.95 (to USA or foreign: add \$1 for shipping, or \$4 by AIR; in Calif. add \$1.20 tax).

As pennywise Ben Franklin said, "*An investment in knowledge pays the best dividends.*" **GET STARTED NOW** — Tax deductible for professionals.

**MONEY-BACK GUARANTEE!** Send for it today. Be sure to give me your complete mailing address with your check or money order. If you want to charge it (Visa or MC), tell me your card no. and exp. date. Prompt shipment guaranteed.

Thank you! EduCALC Publications, Dept. G-4  
Box 974, Laguna Beach, California 92652  
In Calif. (also AK and HI), call 714-497-3600;  
elsewhere TOLL FREE 24-hour Credit Card orders:  
800-854-0561, Ext. 845; Dept. G-4

# C.E.T.

FOR TECHNICIANS WHO ARE READY FOR THE FUTURE

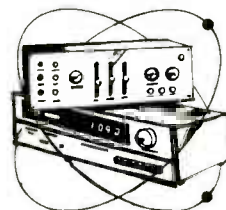

**CERTIFIED ELECTRONICS TECHNICIAN**

Certification is available in the following areas:

- AUDIO
- COMMUNICATIONS
- INDUSTRIAL
- MATV
- MEDICAL
- RADIO-TV

Write to: THE INTERNATIONAL SOCIETY OF CERTIFIED ELECTRONICS TECHNICIANS  
2708 West Berry, Fort Worth, TX 76109

Please send me:

- Free booklet: CAREERS IN THE ELECTRONICS INDUSTRY (a stamped self-addressed envelope is enclosed)
- Information about the CET Test.
- A list of test administrators in my state/country.
- I am already a CET. Send me information about IS CET membership. CET No. \_\_\_\_\_

NAME \_\_\_\_\_

ADDRESS \_\_\_\_\_

CITY \_\_\_\_\_ STATE \_\_\_\_\_

ZIP \_\_\_\_\_ PHONE ( ) \_\_\_\_\_





# GET BURGLARS COMING AND GOING.

Every 10 seconds, a burglary takes place somewhere in the United States. There was a 20% rise in violent crime during 1980, the highest in 10 years.

Luckily, we have two unique products to help keep you from becoming another crime statistic.

## 1. Portable intrusion alarm

How can you protect your home or business without spending a fortune on a perimeter security system? How about when you're sleeping in a hotel room, an easy mark for the growing population of hotel burglars?

Simply place the pocket-sized SensAlert™ in any room, aiming the sensor towards doors or windows. As soon as an intruder enters, the movement triggers a piercing alarm.

At home, a SensAlert in every room protects you while you're in the house. It's different from (and less expensive than) perimeter security systems, which are turned on while you're away. Even place SensAlert at your backyard gate while you sunbathe; the tone tells you someone's arrived.

Carry a SensAlert in your briefcase or pocket when you travel, to protect the entire hotel room, not just the door.

There's no installation and no electric wire; SensAlert is battery-operated. It can be set to work either in the daytime or at night.

A free sign for your door knob is included with each order. It warns that the room is protected by SensAlert.

Put SensAlert in your desk drawer at the office. It will go off if anyone opens it while you're out.

A built-in light allows you to use SensAlert as an emergency flashlight. The alarm can also be triggered manually, for a distress signal.

## 2. Plug-in theft protection

Valuable electrical equipment is at the top of a burglar's hit list. Typewriters, adding machines, TV's, stereos, tape recorders, power tools.

It only takes a few seconds to unplug and carry off a TV or typewriter. A quick, easy theft and resale. You're vulnerable at home and at the office.

Before Alertmate™, you had two choices: bolt appliances to furniture, or invest in a costly and complex security system.

Now, you can simply plug the Alertmate into the wall outlet, secure it with one screw, and plug in the appliance.

If a thief pulls out the plug, a piercing alarm goes off. And keeps going. A definite theft deterrent! The only way to deactivate the alarm is to plug the appliance back in, or dial the correct number code. The alarm will also ring if the cord is cut.

A free sticker is included. It states that the equipment is protected by Alertmate, and gives you a space to write in the name of an individual who has the combination.

When you want to move equipment

yourself, you simply deactivate the alarm with the combination. Protect each piece of expensive equipment inexpensively and easily, with Alertmate.

## 30-day free trial

It could cost you over \$1,000 to install security systems giving you the same amount of protection as SensAlert and Alertmate.

1. Alertmate, the plug-in alarm for valuable equipment, is only \$24.95 including the free sticker plus \$2.50 postage and handling.

2. SensAlert, the portable intrusion alarm with flashlight, soft-tone feature, and free door hanger, is \$39.95 plus \$2.50 postage and handling.

Order both at \$64.90 and pay the \$2.50 postage and handling only once: (Total: \$67.40) Batteries not included. Credit card holders: use our toll free number.

**Order Toll Free:**  
**(800) 423-6383**

**In California: (800) 352-6207**

**SUNSHINE  
EXPRESS**

4357 Chase Avenue  
Los Angeles, CA 90066  
© Copyright 1981 Sunshine Express

# EQUIPMENT AND TRAINING NO OTHER SCHOOL CAN MATCH.

**NTS HOME TRAINING INVITES YOU TO EXPLORE MICROCOMPUTERS,  
DIGITAL SYSTEMS AND MORE, WITH STATE-OF-THE-ART EQUIPMENT  
YOU ASSEMBLE AND KEEP.**

Without question, microcomputers are the state of the art in electronics. And NTS is the only home study school that enables you to train for this booming field by working with your own production-model microcomputer.

We'll explain the principles of troubleshooting and testing your microcomputer and, best of all, we'll show you how to program it to do what you want.

You'll use a digital multimeter, a digital logic probe and other sophisticated testing gear to learn how to localize problems and solve them.

Send for the full color catalog in the electronics area of your choice—discover *all* the advantages of home study with NTS!

NTS also offers courses in Auto Mechanics, Air Conditioning and Home Appliances. Check card for more information.

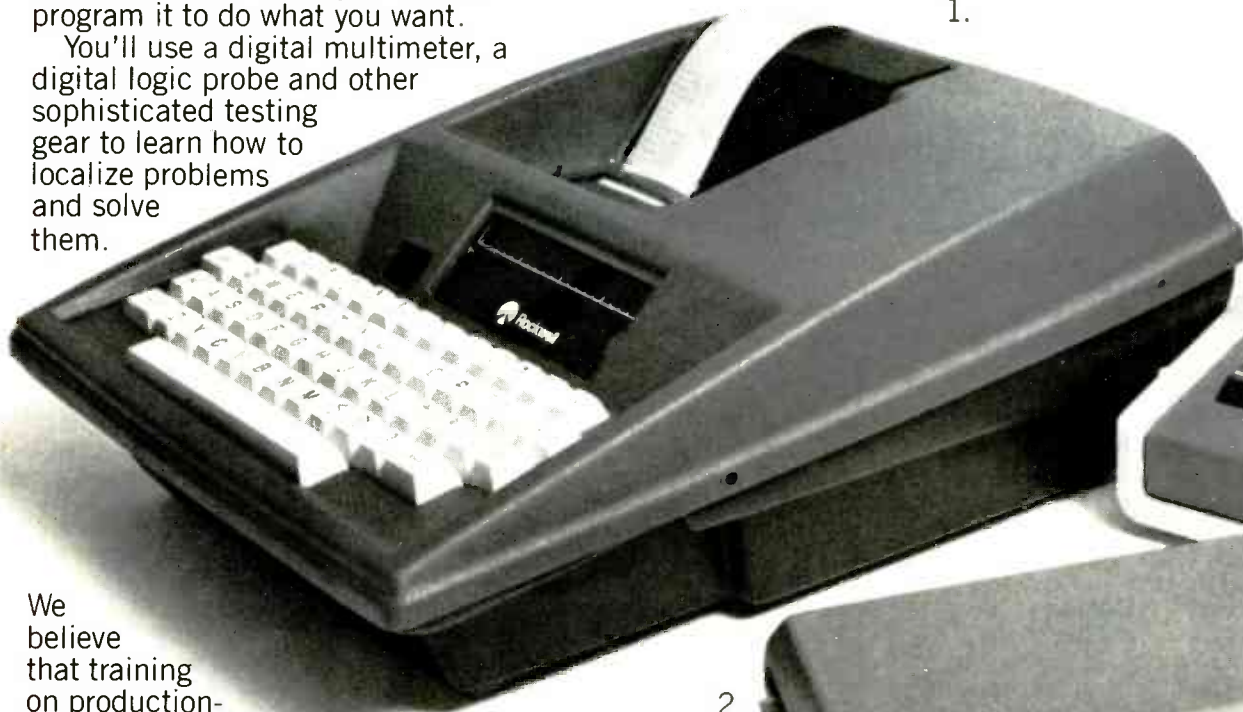

We believe that training on production-model equipment, rather than home-made learning devices, makes home study more exciting and relevant. That's why you'll find such gear in most of NTS's electronics programs.

For instance, to learn Color TV Servicing you'll build and keep the 25-inch (diagonal) NTS/HEATH digital color TV.

In Communications Electronics you'll be able to assemble and keep your own NTS/HEATH 2-meter FM transceiver, plus test equipment.

But no matter which program you choose, NTS's Project Method of instruction helps you quickly to acquire practical know-how.

2.







Simulated TV Reception

4.

3.

**1. The NTS/Rockwell AIM 65**

**Microcomputer** A single board unit with on-board 20 column alphanumeric printer and 20 character display. A 6502-based unit 4K RAM, expandable.

**2. The NTS/KIM-1 Microcomputer** A single board unit with 6 digit LED display and on-board 24 key hexadecimal calculator-type keyboard. A 6502 based microcomputer with 1K RAM, expandable.

**3. The NTS/HEATH H-89 Microcomputer** features floppy disk storage, "smart" video terminal, two Z80 micro-processors, 16K RAM memory, expandable to 48K. **4. The NTS/HEATH GR-2001 Digital Color TV (25" diagonal)** features specialized AGC-SYNC muting, filtered color and new solid-state high voltage tripler rectifier.

# NTS NATIONAL TECHNICAL SCHOOLS

TECHNICAL-TRADE TRAINING SINCE 1905  
Resident and Home-Study Schools  
4000 SO. FIGUEROA ST., LOS ANGELES, CA. 90037



**NATIONAL TECHNICAL SCHOOLS**

4000 South Figueroa Street, Dept. 206-032  
Los Angeles, California 90037

Please rush FREE color catalog on course checked below

- |   |   |
|---|---|
| <input type="checkbox"/> MicroComputers/MicroProcessors | <input type="checkbox"/> Auto Mechanics     |
| <input type="checkbox"/> Communications Electronics     | <input type="checkbox"/> Air Conditioning   |
| <input type="checkbox"/> Digital Electronics            | <input type="checkbox"/> Home Appliances    |
| <input type="checkbox"/> Industrial Technology          | <input type="checkbox"/> Color TV Servicing |

Name \_\_\_\_\_ Age \_\_\_\_\_

Address \_\_\_\_\_

Apt. \_\_\_\_\_ City \_\_\_\_\_

State \_\_\_\_\_ Zip \_\_\_\_\_

- Check if interested in G.I. information.  
 Check if interested ONLY in classroom training in Los Angeles.

THESE 1981 B&K OSCILLOSCOPES  
ARE IN STOCK AND AVAILABLE  
FOR IMMEDIATE DELIVERY

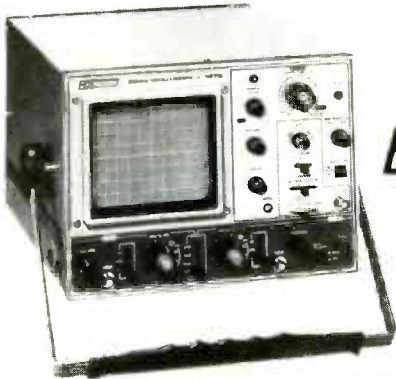

**BK PRECISION**

- 1479A Dual-Trace 30 MHz
- 1477 Dual-Trace 15 MHz
- 1432 Dual-Trace 15 MHz Portable
- 1476 Dual-Trace 10 MHz
- 1466 Single-Trace 10 MHz
- 1405 Single-Trace 5 MHz
- 1420 Dual-Trace 15 MHz Portable

CALL FOR OUR  
EARLY BIRD SPECIAL LOW PRICE

**PORTABLE  
OSCILLOSCOPES**  
BATTERY OPERATED



Non-Linear Systems

Call For Our Prices

MS-15



Single Trace 15MHz

MS-215



Dual Trace 15 MHz

MS-230



Dual Trace 30MHz

**FLUKE** DIGITAL MULTIMETERS

- Six functions
- 3½-digit resolution
- dc voltage
- ac voltage
- dc current
- ac current
- resistance
- diode test
- 0.25% basic dc accuracy
- LCD display
- Overload protection

Model 8022B:  
The Troubleshooter

\$139

Model 8020B:  
The Analyst

\$189

Model 8024A:  
The Investigator

\$239



**NEW**

• Seven functions

- dc voltage
- ac voltage
- dc current
- ac current
- resistance
- diode test
- conductance (1/R)
- 3½-digit resolution
- 0.1% basic dc accuracy
- LCD display
- Overload protection
- Two year parts and labor warranty

• Nine functions

- dc voltage
- ac voltage
- dc current
- ac current
- resistance
- diode test
- conductance (1/R)
- logic level and continuity detect
- temperature (K-type thermocouple)
- Peak hold on voltage and current functions
- Selectable audible indicator for continuity or level detection
- 3½-digit resolution
- 0.1% basic dc accuracy
- LCD display
- Overload protection

**KEITHLEY MODEL 130  
DIGITAL MULTIMETER**



\$125.

|            | RANGE                         | ACCURACY |
|------------|-------------------------------|----------|
| DC VOLTAGE | 200mV, 2V, 20V, 200V, 1000V   | .5%      |
| AC VOLTAGE | 200mV, 2V, 20V, 200V, 750V    | 1%       |
| DC CURRENT | 2mA, 20mA, 200mA, 2000mA, 10A | 2%       |
| AC CURRENT | 2mA, 20mA, 200mA, 2000mA, 10A | 3%       |
| RESISTANCE | 200Ω, 2kΩ, 20kΩ, 200kΩ, 20MΩ  | .5%      |

**DATA PRECISION  
Model 938  
0.1%, 3½-Digit, LCD DIGITAL  
CAPACITANCE  
METER**



\$219

- WIDE RANGING — from 199.9 pF full scale (0.1 pF resolution) up to 1999 μF full scale, in eight ranges...virtually every capacitance you'll ever need to measure.
- FAST AND EASY TO USE — Direct reading, pushbutton ranges. Just plug in and read.
- EXCEPTIONALLY ACCURATE — provides ±0.1% basic accuracy.
- TOUGH AND COMPACT — Built to take rough usage without loss of calibration accuracy. Fits and goes anywhere, takes very little bench space, always handy for quick capacitance checkout, matching, calibration, and tracking.
- PORTABLE — Palm-sized, light-weight, operates up to approximately 200 hours on a single 9V alkaline battery.
- EASY READING — big, clear, high-contrast 3½-digit LCD display, a full 0.5" high, readable anywhere.
- VALUE PACKED — Outstanding measurement capability and dependability. Outperforms DC time-constant meters, and even bridges costing 2 to 5 times as much.
- RELIABLE — warranted for 2 full years.



# WESTON

The Roadrunner  
Model 6100

**SPECIAL**



# KEITHLEY

Model 169  
BENCH/PORTABLE DMM

- 3½ Digit liquid crystal display
  - 0.25% basic accuracy
  - 26 Ranges
- \$189.00**



## 80MHz Counter with Period Function



MODEL 1820

- 5Hz to 80MHz reading guaranteed—100MHz typical
- Period measurements from 5Hz to 1MHz.
- Period average, auto and manual positions
- One PPM resolution
- Totalizes to 999999 plus overflow
- Elapsed time measurements from .01 to 9999.99 seconds plus overflow
- One-megohm input resistance
- Bright .43" high LED readouts

Call For Our Price

## New Low Distortion Function Generator

**BK PRECISION**



MODEL 3010

- Generates sine, square and triangle waveforms
- Variable amplitude and fixed TTL square-wave outputs
- 0.1 Hz to 1MHz in six ranges
- Push button range and function selection
- Typical sine wave distortion under 0.5% from 0.1Hz to 100kHz
- Variable DC offset for engineering applications
- VCO external input for sweep-frequency tests

Call For Our Price

## New Sweep/Function Generator

**BK PRECISION**



MODEL 3020

- Four instruments in one package—sweep generator, function generator, pulse generator, tone-burst generator
- Covers 0.02Hz-2MHz
- 1000:1 tuning range
- Low-distortion high-accuracy outputs
- Three-step attenuator plus vernier control
- Internal linear and log sweeps
- Tone-burst output is front-panel or externally programmable

Call For Our Price

**SAVE UP TO \$500**

# HITACHI

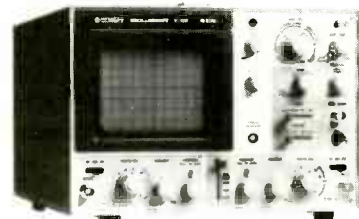

- V-151B 15 MHz Single Trace
- V-152B 15 MHz Dual Trace
- V-202 20 MHz Dual Trace
- V-301 30 MHz Single Trace
- V-302B 30 MHz Dual Trace
- V-352 35 MHz Dual Trace
- V-550B 50 MHz Dual Trace, Dual Time Base
- V-1050 100 MHz Dual Trace, Dual Time Base

Call For  
Special  
REBATE OFFER

We carry a full line of multimeters, oscilloscopes, frequency counters, audio and RF generators, power supplies and accessories.

Just call our Toll-Free number and one of our experts will answer all your questions about test equipment.

|                    |              |
|--------------------|--------------|
| HITACHI            | KEITHLEY     |
| Non-Linear Systems |              |
| FLUKE              | HICKOK       |
| VIZ formerly VIZ   | TRIPLET      |
| PHILIPS            | WESTON       |
| Simpson            | BK PRECISION |
| LEADER             | DORIC        |
| DATA PRECISION     |              |

## ADVANCE ELECTRONICS

THE TEST EQUIPMENT SPECIALISTS

TOLL FREE HOT LINE  
**800-223-0474**



54 WEST 45th STREET, NEW YORK, N.Y. 10036  
IN NEW YORK STATE 212-687-2224

## EQUIPMENT REPORTS

continued from page 26

ing ranges available on the program-able-scanner market.

The *PRO-2020* will scan up to 20 channels and has automatic up- and down-search capability as well. Mobile or fixed-station operation is possible, and a 9-volt battery is used as a backup to hold memory in case of power failure.

The large fluorescent display indicates channel number, frequencies, scan status, search monitoring, and

other functions. A priority feature for any of the 20 channels is included. Functions, channel selections, etc. are entered using a large 24-button keypad; there is audible feedback (the scanner "beeps" at you) each time a programming key is pressed. A LOCK OUT key allows you to disable unwanted channels temporarily, and a built-in SKIP function lets the scanner jump over those unwanted channels, speeding up the scan rate.

Fast (9 channels/second) and slow (4 channels/second) search and scan speeds can be selected using the keypad. A keypad-selected DELAY function can be used if you want to keep the

scanner on a channel for two seconds after the end of a transmission; that function allows you to catch a reply transmission that you might otherwise have missed by moving immediately to the next active channel.

### Inside the cabinet

The dual-conversion (10.7 MHz and 455 kHz) superheterodyne circuitry uses an LSI microprocessor chip, an LSI phase-locked-loop system, seven CMOS IC's, eight additional IC's, 40 transistors, and 45 diodes.

Spurious-signal rejection is specified as 50 dB for VHF frequencies; spurious-signal rejection for UHF frequencies is not indicated. IF selectivity is +9 kHz at -6 dB; +15 kHz -50 dB.

The sensitivity of this model is greatly improved compared to previous Radio Shack scanners. When checked against a competitive scanner costing nearly twice as much, the apparent sensitivity was nearly identical; when we measured the sensitivity of the two units, they were within 0.1 dB of each other. The claimed sensitivity was 0.5  $\mu$ V for the low and high bands, and 1.0  $\mu$ V for the VHF aircraft-band and at UHF frequencies.

This large (10 x 11 x 3) scanner also includes a screw-on collapsible whip antenna for close-in reception. A rear-apron external-antenna jack allows the use of a rooftop antenna for improving the quality of long distance and weak-signal reception.

The instruction manual is well written and useful. It contains concise step-by-step programming information as well as an informative practical guide to scanner applications and frequency allocations.

A block diagram is also included; although it would be of little use in the maintenance of the receiver, it does give the technically-inclined user some idea of how the scanner works.

### Our test

Signal sensitivity was found to be uniformly good over all frequency-ranges. Measurements showed the *PRO-2020* to be virtually identical to the most sensitive of its competitors. While search and scan speeds are not as rapid as those of some other scanners, the receiver does have a unique feature—a sophisticated window-detector that assures the user that the scanner will stop precisely on frequency, without overshoot or undershoot.

In this age of bells and whistles, the Realistic *PRO-2020* offers high performance and straightforward design at a reasonable cost. The *PRO-2020* sells for \$299.95 and is available at Radio Shack stores.

R-E

## ADVANCE IS PROUD TO INTRODUCE the KEITHLEY Line of High Quality Digital Multimeters Featuring The New 130 Hand-Held DMM

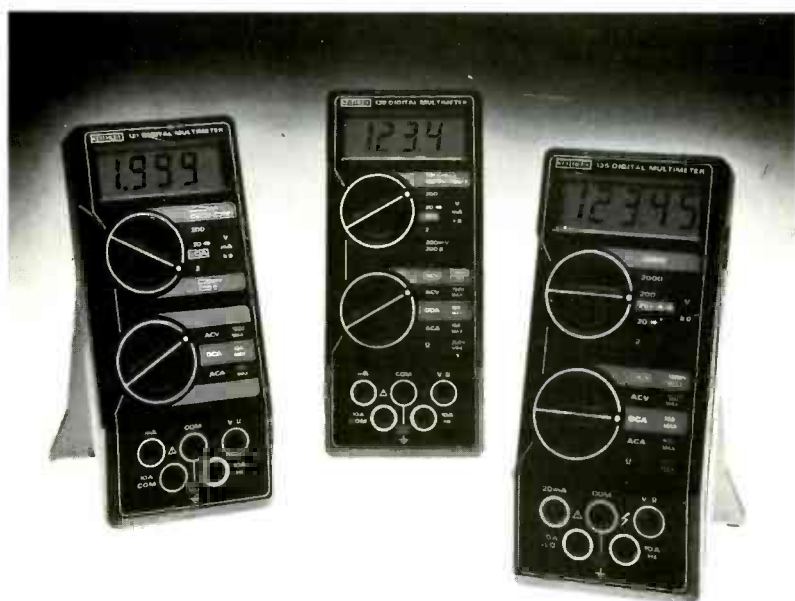

**Rugged DMMs from Keithley** — all feature large, bright LCD display, easy-to-use rotary switches, externally accessible battery and fuse, 10A current range, diode test capability, low battery indicator, cushioned components.

**Model 131.** Similar to Model 130, with increased accuracy... **\$139**

**Model 130.** Our most popular model, the price/performance champ... **\$125**

**Model 135.** First 4½-digit DMM with hand-held convenience... **\$235**

| MODEL | ACCURACY |       |     |      |          | SENSITIVITY |            |             |           |               |
|-------|----------|-------|-----|------|----------|-------------|------------|-------------|-----------|---------------|
|       | DCV      | DCA   | ACV | ACA  | $\Omega$ | DCV         | DCA        | ACV         | ACA       | $\Omega$      |
| 130   | 0.5%     | 1%    | 1%  | 2%   | 0.5%     | 100 $\mu$ V | 1 $\mu$ A  | 100 $\mu$ V | 1 $\mu$ A | 100m $\Omega$ |
| 131   | 0.25%    | 0.75% | 1%  | 2%   | 0.2%     | 100 $\mu$ V | 1 $\mu$ A  | 100 $\mu$ V | 1 $\mu$ A | 100m $\Omega$ |
| 135   | 0.05%    | 0.5%  | 1%  | 1.5% | 0.2%     | 100 $\mu$ V | 10 $\mu$ A | 100 $\mu$ V | 1 $\mu$ A | 100m $\Omega$ |

Case \$10.00 Shipping \$3.00

THE TEST EQUIPMENT SPECIALISTS  
TOLL FREE HOT LINE  
800-223-0474

54 WEST 45th STREET, NEW YORK, N.Y. 10036 212-687-2224

**ADVANCE ELECTRONICS**





**GC Electronics  
Magnameter  
Microwave Oven Tester**



CIRCLE 102 ON FREE INFORMATION CARD

| GC                 | Magnameter |   |   |      |   |   |   |      |   |    |           |
|--------------------|------------|---|---|------|---|---|---|------|---|----|-----------|
| OVERALL PRICE      | [Red bar]  |   |   |      |   |   |   |      |   |    |           |
| EASE OF USE        | [Red bar]  |   |   |      |   |   |   |      |   |    |           |
| INSTRUCTION MANUAL | [Red bar]  |   |   |      |   |   |   |      |   |    |           |
| PRICE/VALUE        | [Red bar]  |   |   |      |   |   |   |      |   |    |           |
|                    | 1          | 2 | 3 | 4    | 5 | 6 | 7 | 8    | 9 | 10 |           |
|                    | Poor       |   |   | Fair |   |   |   | Good |   |    | Excellent |

FOR MANY YEARS, THE GC ELECTRONICS Co. has been making a huge variety of parts for electronics work. They've been around for longer than I can remember, at the same address, 400 S. Wyman, Rockford, IL 61101. Now, they've gone into the test-instrument field.

This one is the *Magnameter*, catalog No. 20-226. It's a specialized microwave oven tester, for analyzing the operation of the magnetron by reading secondary voltage and current. The meter has two ranges, with a toggle switch to select between the two. With the range switch in the HIGH position, the meter reads secondary voltages up to 10 kV. In the LOW position, the meter reads up to 10 volts. That range is used to measure the plate current of the magnetron, by reading the voltage drop across the plate resistor. For those ovens with no plate resistor, a heavy-duty 10-ohm tester is included, encased in plastic with alligator clips on both ends. That can be connected in the ground loop of the power-supply circuit. If the oven has a plate resistor of a value other than 10 ohms, a handy conversion chart is included for reading current.

The construction of the instrument is good: the case is high-impact plastic, and the test leads are very heavily insulated; twice the size of ordinary ones. Rubber-booted alligator clips are used

on all three leads—ground, low, and high. After the tests are completed, a DISCHARGE switch on the side of the case can be depressed to short out any remaining charge left in the circuit. A neon lamp labelled HIGH VOLTAGE, and located on the front panel, glows whenever high voltages are present in the circuit—even if the oven is off.

The *Magnameter* is a compact instrument, and it comes with a tilt handle that can be used as a bail or stand. Test-leads are permanently connected, and all connections are made with the microwave oven's power switch turned off. The test leads are long enough to let you set the meter on top of the micro-

wave-oven chassis.

The two major faults associated with microwave ovens are shorted magnetrons and shorted power transformers. By disconnecting the plate lead to the magnetron and measuring the output voltage of the power supply, then reconnecting the plate lead and measuring the plate voltage and plate current, you can isolate those two faults very quickly, and that's the name of the game.

The *Magnameter* seems to be built to give good service for a long time. List-priced at only \$86.68, it looks like quite a lot of meter for the money; it should come in handy if you're going into that end of the electronics business. **R-E**

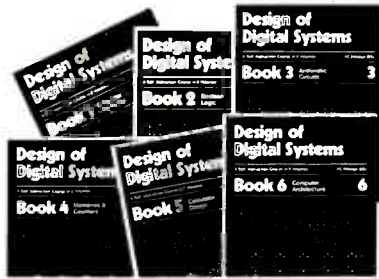

*Design of Digital Systems - six volumes*

**ADVANCED COURSE  
DESIGN OF DIGITAL SYSTEMS**

Six large-format volumes — each 11 1/2 x 8 1/2"

**CONTENTS**

The contents of Design of Digital Systems include:

Book 1: Octal, hexadecimal and binary number systems; representation of negative numbers; complementary systems; binary multiplication and division.

Book 2: OR and AND functions; logic gates; NOT, exclusive OR, NAND, NOR and exclusive-NOR functions; multiple input gates; truth tables; DeMorgan's Laws, canonical forms; logic conventions, Karnaugh mapping; three-state and wired logic.

Book 3: Half adders and full adders; subtractors; serial and parallel adders; processors and arithmetic logic units (ALUs); multiplication and division systems.

Book 4: Flip-flops; shift registers; asynchronous counters; ring, Johnson and exclusive-OR feedback counter; random access memories (RAMs); read-only memories (ROMs).

Book 5: Structure of calculators, keyboard encoding; decoding display data; register systems; control unit; program ROM; address decoding; instruction sets; instruction decoding; control program structure.

Book 6: Central processing unit (CPU); memory organization; character representation; program storage; address modes; input/output systems; program interrupts; interrupt priorities programming; assemblers; executive programs; operating systems, and time-sharing.

**OUR CUSTOMERS**

Design of Digital Systems has been bought by more than half the 50 largest corporations in America, and by Motorola, Intel, DEC, National Semiconductor, Fairchild, General Instrument, Hewlett-Packard, Heath Co., M.I.T., NASA, Smithsonian Institute, Bell Telephone Labs. And many, many more, as well as corporations and individuals in over 50 countries.

**CAMBRIDGE LEARNING Inc.**

1 Judith Drive  
North Reading,  
MA 01864

Call (617) 664-3657 to  
order by phone—free

7 days, 24 hours

- Order free by phone
- Mastercharge/VISA
- No shipping charges
- Money-back guarantee
- Tax deductible
- Save \$5

**Designing  
Digital Systems**

Two programmed learning courses:  
hardware and software; theory  
and application.

**BASIC COURSE**



*Digital Computer Logic & Electronics*

**CONTENTS**

Digital Computer Logic and Electronics is designed for the beginner. No mathematical knowledge other than simple arithmetic is assumed, though you should have an aptitude for logical thought. It consists of 4 volumes — each 11 1/2" x 8 1/2" — and serves as an introduction to the subject of digital electronics.

Contents include: Binary, octal and decimal number systems; conversion between number systems; AND, OR, NOR and NAND gates and inverters; Boolean algebra and truth tables; DeMorgan's Laws; design of logical circuits using NOR gates; R-S and J-K flip-flops; binary counters, shift registers and half-adders.

**NO RISK GUARANTEE**

There's absolutely no risk to you. If you're not completely satisfied with your courses, simply return them to CLI within 30 days. We'll send you a full refund, plus return postage.

**TAX DEDUCTIBLE**

In most cases, the full cost of CLI courses can be a tax deductible expense.

**PHONE ORDERS - FREE**

To order by phone, call (617) 664-3657 with your credit card information. It won't cost you a dime, because we'll deduct the cost of your call from the price of the courses you order.

**TO ORDER BY MAIL**

You may use the order form below if you wish, but you don't need to. Just send your check or money order (payable to Cambridge Learning, Inc.) to the address below. If you don't use the order form, make sure your address is on your check or the envelope, and write "DOS" (Design of Digital Systems), "DCE" (Digital Computer Logic & Electronics), or "both" (both courses) on your check.

Mass. Residents add 5% sales tax. We pay all shipping costs.

We also accept company purchase orders.

**AIR MAIL**

The prices shown include surface mail postage anywhere in the world. Air mail postage costs an extra \$10 for both courses (10 volumes).

**DISCOUNTS**

Call or write for details of educational and quantity discounts, and for dealer costs.

**SAVE \$5**

If you order both courses, you save \$5. Order at no obligation today.

To: Cambridge Learning Inc., 1 Judith Drive, North Reading, MA 01864

Please send me

\_\_\_ sets of Design of Digital Systems ..... \$19.95 \$ \_\_\_\_\_

\_\_\_ sets of Digital Computer Logic & Electronics ..... \$14.95 \$ \_\_\_\_\_

\_\_\_ sets of both courses ..... \$29.90 \$ \_\_\_\_\_

Enclosed is check/money order (payable to Cambridge Learning Inc.) for total \$ \_\_\_\_\_

NAME \_\_\_\_\_

ADDRESS \_\_\_\_\_

CITY/STATE/ZIP \_\_\_\_\_ R10

CIRCLE 55 ON FREE INFORMATION CARD

# NOBODY SELLS MORE TEST THAN FORDHAM BECAUSE

**BK PRECISION**

## CRT Restorer Analyzer



With High Speed Multiplex Technique  
**Model 467**  
 • Restores color and B/W picture tubes like new! Uses the most powerful restoration method known with minimal danger to the CRT. • Exclusive multiplex test technique

## Portable Digital Capacitance Meter

**Model 820**  
 • Measures capacitance from 0.1 pF to 1 Farad. • Resolves to 0.1 pF. • 10 ranges for accuracy and resolution. • 4 digit easy to read LED display. • 0.5% accuracy. • Special lead insertion jacks or banana



## Sweep/Function Generators

**Model 3015**  
 • Frequency: 2 Hz to 200 kHz, in 3 ranges. • Outputs: Sine, square or triangle. • Variable Amplitude: 15 V p-p, open circuit; 7.5 V p-p into 600 ohms. • Pulse Output: Fixed amplitude TTL level, logic high greater than 3 volts. • Accuracy:  $\pm 5\%$  F.S., to 20 kHz.

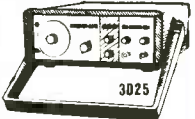

**Model 3025**  
 • Frequency: 0.005 Hz to 5 MHz in 7 ranges. • Outputs: Sine, square, triangle or haversine. • Variable Amplitude 20 V p-p, open circuit; 10 V p-p, into 50 ohms. • Accuracy:  $\pm 5\%$  F.S.

**Model 3030**  
 • Frequency: 0.001 Hz to 5 MHz in 8 ranges. • Outputs: Sine, square, triangle, pos/neg square, pos/neg ramp. • Variable Amplitude: 20 V p-p, open circuit; 10 V p-p, into 50 ohms. • Accuracy:  $\pm 1.5\%$  setting +1% F.S., 0.001 Hz to 1 MHz;  $\pm 2\%$  setting +2% F.S., 1 MHz to 5 MHz.

## Four Instruments in One

**Model 3020**  
 Four instruments in one package - sweep generator, function generator, pulse generator, tone-burst generator • Covers 0.2 Hz to 2 MHz • 1000:1 tuning range • Low-distortion high-accuracy outputs • Three-step attenuator plus vernier control • Internal linear and log sweeps

## Low Distortion Function Generator

**Model 3010**  
 • Generates sine, square and triangle waveforms • Variable amplitude and fixed TTL square-wave outputs • 0.1 Hz to 1 MHz in six ranges • Typical sine wave distortion under 0.5% from 0.1 Hz to 100 kHz.

**Dual-Trace 30 MHz Delayed Sweep Scope**  
**Model 1530**  
 • Delayed sweep operation for sweep expansion up to 1000x. • 30 MHz response; usable to 50 MHz. • 5 mV/division sensitivity, selectable 2 mV to 20 mV. • Variable hold-off for pulse train display. • Single-sweep for nonrepetitive waveforms. • Built-in triggering filters.

**BECKMAN**



## BECKMAN 3 1/2 Digit Multimeters

**TECH 310**  
 Has 7 functions and 29 ranges, plus 0.25% VDC accuracy.

**TECH 350**  
 Bright, 0.5% LCD display. Single easy-to-use switch. Separate diode test function. Low power resistance range. 22 megohms input resistance. 12,000 hour battery life.

**TECH 360**  
 Input jack for a standard K-type thermocoupling, enabling user to measure temp from  $-20^{\circ}\text{C}$  to  $+1265^{\circ}\text{C}$ . Switch selectable measurement of true RMS (AC + DC) or AC only voltages and currents.

**TECH 330**  
 Has 7 functions and 29 ranges, plus 0.1% VDC accuracy and true RMS capability (AC + DC).

**TECH 300**  
 Has 0.5% VDC accuracy and all the features of TECH 310, except the continuity test function and 10-amp current ranges.

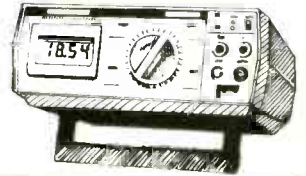

**FLUKE**

## Multimeter

• Free 10 amp current shunt. • General purpose True RMS multimeters with identical features except for power sources.

**Model 810**  
 Operates on line voltage

**Model 811**  
 Operates on line voltage and with rechargeable Ni-Cad batteries.



## Hand Held DMM with free case

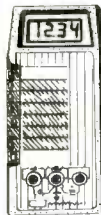

**Model D800**  
 Fluke's lowest priced DMM. An all purpose instrument for basic measurement needs. Five ranges for AC and DC voltage measurements. Four ranges for AC and DC current tests. Six resistance ranges.

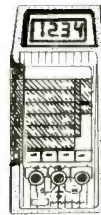

**Model D802**  
 Same as Model D800 but has a basic DC accuracy of 0.1% and Fluke conformance function for accurate high resistance measurement.

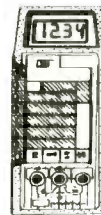

**Model D804**  
 The most powerful in the series. All features of Model D802 plus capability to check continuity and logic levels, measure temp with K-type thermocouples and capture peak readings of transients.

**Simpson**

## Meter

**Model 260-7**

• 28 time-proven ranges. • Direct dial reading of Amp-Clamp ranges. • Only 2 batteries... one 9-volt and one 1.5 volt "D" cell. • 260-7 complete with batteries, test leads and manual. • 260-7M with mirror scale. • 260-7RT in roll case. • 260-7MRT with mirror scale, in roll top case. Available with reset pushbutton releases when overload exists.

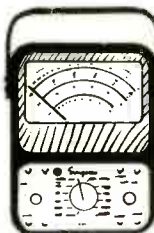

260-7

## 3 1/2 Digital Multimeter

**Model 467**

• LCD analog bargraph to indicate nulls, peaks and trends. • Differential peak hold captures maximum (peak) and minimum values of complex waveforms. • 50 u/sec pulse detection. • True RMS measuring capability.



**MLS**

## Touch/Test 20 Multimeter

• Touch selection and control of functions, ranges and power. • Large (0.53" high) LED readout. • Automatic polarity and overload indication. • In-circuit test capabilities.

**Model TT-20**

**Model TT-20B** With batteries and charger

**Model TT-21** With LCD readout

**Model TT-21B** With LCD readout, batteries and charger



TT-20

## Portable Triggered Miniscopes

MS-15



**Model MS-15** 15 MHz

**Model MS-215** 15 MHz, Dual Trace

**Model MS-230** 30 MHz, Dual Trace

**FORDHAM**

855 Conklin St., Farmingdale, N.Y. 11735  
 ■ Master Charge ■ BankAmericard  
 ■ Visa ■ COD ■ Check ■ Money Order

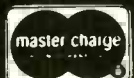



# EQUIPMENT AND TOOLS NOBODY SELLS FOR LESS!

**GLOBAL  
SPECIALTIES  
CORP**

**3½ Digit  
0.1% Digital  
Capacitance Meter**



Model 3001

**Universal Counter-Timer**



Model 5001

For the electronic measurement and display of frequency, period, interval and counted events. Unique full input signal conditioning.

**Frequency Counter**



Model 6001

• 5 Hertz to 650 MHz • 10 MHz crystal oven timebase input • Selectable 0.1, 1.0, 10 sec gate • Switchable low pass 50 KHz filter • True TTL compatibility at input

**KEITHLEY**

**Hand-Held Beeper  
Digital Multimeter**

Model 128

• LCD display. • 0.5% basic accuracy. • 3½ digit resolution. • 'Beeper' operates on all ranges and functions.

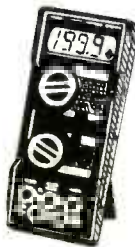

**Hand-Held Digital  
Multimeter**

Model 130

• 0.5% basic accuracy. • 3½ LCD display.

**4½ Digit  
Multimeter**

Model 135

• 0.5% basic accuracy. • 4½ digit resolution provides wide dynamic range. • LCD display.

**HITACHI**  
Hitachi Densetsu, Ltd.

**Dual Trace  
Oscilloscopes**

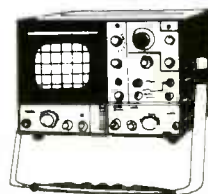

Economically priced, general-purpose oscilloscopes. Square, 5½" CRT with internal graticule (illuminated scale). High accuracy voltage axis and time axis set at ±3% (certified at 10°C and 35°C). High-sensitivity design, vertical sensitivity of 1 mV/div. available. 8-div. dynamic range ensures accurate measurement of waveforms without distortion. TV sync-separator circuit.

**20 MHz  
Model  
V-202**

**35 MHz  
Model  
V-352**

**100 MHz  
Model  
V-1050**

**LEADER**

**10 MHz  
at 1 mV  
5" Scopes**

Model LBO-513

Single Trace with probe

Model LBO-514

Dual Trace with probes

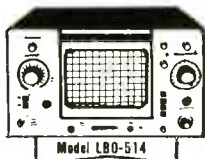

**20 MHz Oscilloscopes**

• Add and subtract modes (with CH-2 invert), permits differential measurements (Model LBO-508A only). • Front panel X-Y operation ideal for phase-shift analysis, sweep alignment and vectorscope service (Model LBO-508A only). • 17.5 nanosec rise time for easy viewing of high speed pulses and wave forms.

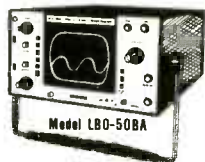

Model LBO-507A

Single Trace with probe

Model LBO-508A

Dual Trace with probes

**LUXO**

**Magnifier  
Lamp**

Model LFM-1A

Offers large viewing area for fine details, component assembly and other close work. Has unique double lens control. In grey, black, white and tan. Three diopter, 13" focus standard on all models. (45" reach).



**Magna-Lux Lamp**

Model LUX-2A

Magnifier utility lamp. The 3¼" diameter lens supplemented by a 40-watt standard appearance bulb A-15 incandescent bulb. Sold in black only, has an arm reach of 39" and includes a factory installed 3-diopter lens. Same magnification as LFM-1A.



**Weller**

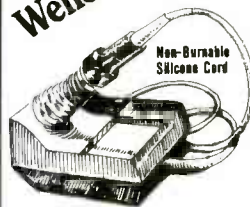

**Controlled  
Output  
Soldering  
Station**

Model WTCP-N

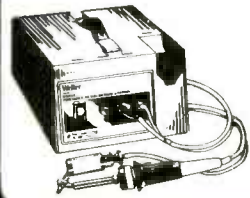

**Portable  
Desoldering  
Stations**

Model DS-600

**Weller  
Xcelite**

**Attache Style Tool Cases**



Model TC-200/ST

Smaller version of the TC-100 case. 27 interchangeable Series 99 screwdrivers and nutdrivers, for use with the straight or tee handle, plus 10 assorted snips, pliers, wire cutters and wrenches.

Model TC-150/ST

Contains 23 individual tools, 24 Series 99 interchangeable screwdriver/nutdriver blades and handles, 2 measuring tapes, soldering iron, recharger, solder.



Model TC-100/ST

53 individual screwdrivers, nutdrivers, pliers and wrenches, 31 Series 99 interchangeable screwdriver/nutdriver blades and handles, and two screwdriver/nutdriver sets.

**Service  
Master  
Tool Kit**

Model 99-SM  
24-piece kit



**VIZ**

**DC Power Supply**

Model WP-708

It's a dual DC Voltmeter

It's a triple DC Power Supply

• Three separate completely isolated DC power supplies, two 0-20V @ 0-2A, one fixed 5V @ 4A • Excellent line and load regulation • Fully adj. current limiting on the two variable supplies



**TOLL FREE (800) 645-9518** in N.Y. State call **(516)752-0050**

ITEM NO.  
WK-7

CMOS SAFE

# IC INSERTION/EXTRACTION KIT

- KIT INCLUDES**
- MOS-1416 14-16 CMOS SAFE INSERTER
  - MOS-2428 24-28 CMOS SAFE INSERTER
  - MOS-40 36-40 CMOS SAFE INSERTER
- EX-1 14-16 EXTRACTOR
  - EX-2 24-40 CMOS SAFE EXTRACTOR



**OK MACHINE & TOOL CORPORATION**  
 3455 CONNER ST., BRONX, N.Y. 10475 U.S.A.  
 PHONE (212) 994-6600 TELEX NO 125091



PRINTED IN U.S.A.

PATENT PENDING

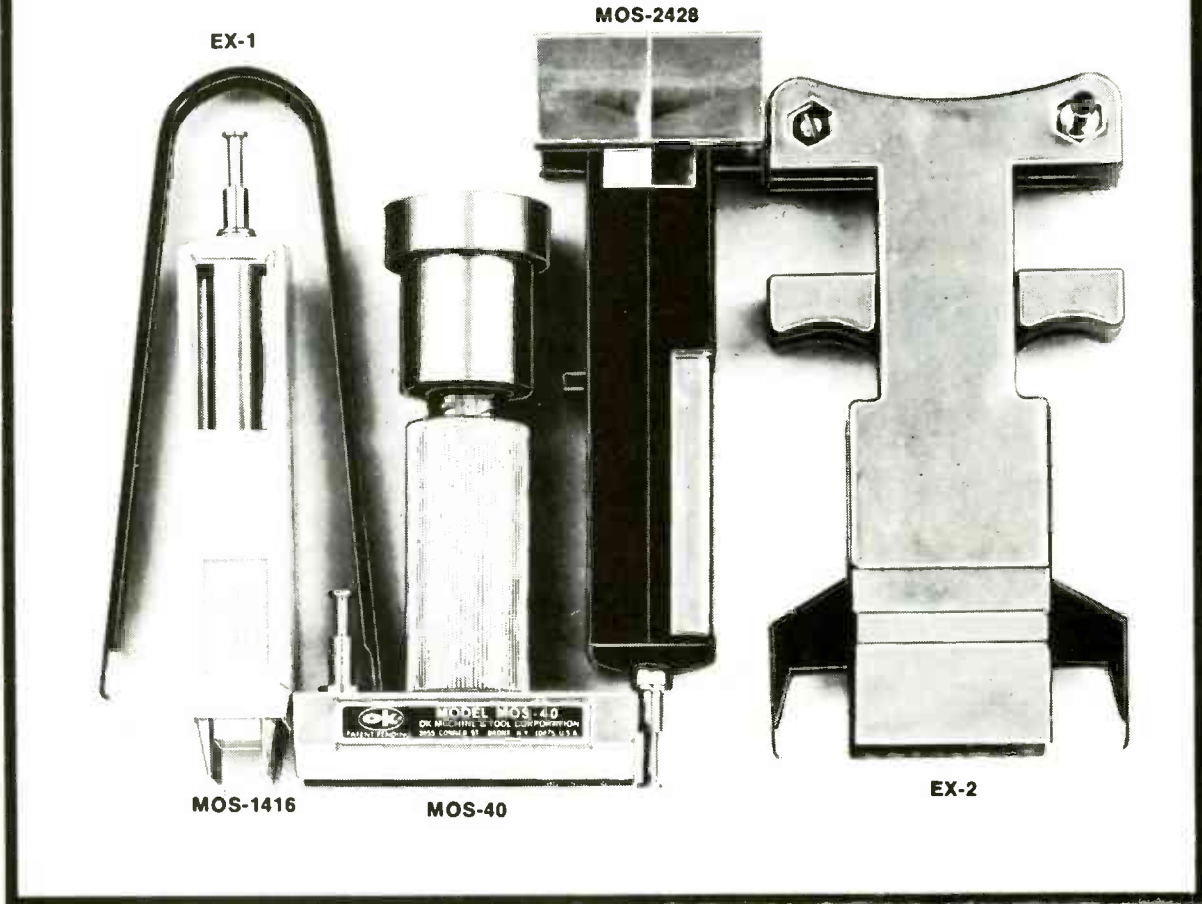

|      |                                    |
|------|------------------------------------|
| WK-7 | COMPLETE IC INSERTER/EXTRACTOR KIT |
|------|------------------------------------|

|                       |
|-----------------------|
| INDIVIDUAL COMPONENTS |
|-----------------------|

|          |                                    |
|----------|------------------------------------|
| MOS-1416 | 14-16 PIN MOS CMOS SAFE INSERTER   |
| MOS-2428 | 24-28 PIN MOS CMOS SAFE INSERTER   |
| MOS-40   | 36-40 PIN MOS CMOS SAFE INSERTER   |
| EX-1     | 14-16 PIN EXTRACTOR TOOL           |
| EX-2     | 24-40 PIN CMOS SAFE EXTRACTOR TOOL |

CALL YOUR LOCAL OK DISTRIBUTOR FOR FURTHER INFORMATION

**OK MACHINE & TOOL CORPORATION 3455 CONNER ST., BRONX, N.Y. 10475 (212) 994-6600/TELEX 125091**



# NEW TECHNOLOGY

## DIGITAL AUDIO DISC



*So far, digital-audio recording technology has confined itself to tape. Now, digital discs are about to make their debut.*

**LEN FELDMAN**  
CONTRIBUTING EDITOR

THE SPRING OF 1981 WILL PROBABLY GO down in history as the time when a major revolution in the science of sound recording took place. During April and May of that year, Holland's Philips Company and Japan's Sony Corporation, in jointly held presentations in Europe and the United States, announced their plans for the introduction of what has come to be known as the compact digital audio disc, or C-DAD.

If the companies meet their production target-dates, Japanese and European music lovers should be able to purchase a new kind of disc player in late 1982, while U.S. audio enthusiasts will have to wait a bit longer—until the beginning of 1983. From all indications, the long wait will be worthwhile, for the new digital C-DAD disc (sometimes acronyms become part of the language long before the item they represent is available) offers a level of performance that has been impossible to obtain with conventional analog records, no matter how carefully they were recorded and processed.

### C-DAD format

The new Philips-Sony C-DAD disc is shown alongside a conventional LP record in Fig. 1. It is capable of playing one hour of stereophonic music *per side*, and can also hold up to four channels of audio on a side with reduced playing time.

Information on the C-DAD disc consists of approximately six billion digital

"bits," which are linearly encoded along a helical track of pits and flats. The tiny pits are about 0.6 microns in width and 0.2 microns deep. The pits and flats represent the "ones" and "zeros" in the digital code used to store the signals. A solid-state laser beam is used to sense the sequence of pits and flats using a spot of light with a diameter several times smaller than that of a human hair. As shown in Fig. 2, the laser beam reads the presence or absence of the pits contained in the disc's surface beneath a protective plastic coating. The scanning rate is approximately 4.3 million bits-per-second. Variations in the reflected light rays are then converted into digital code and



FIG. 1—THE 4.7-INCH DIAMETER C-DAD disc contains one hour of music on a side compared to a little over 20 minutes for a conventional 12-inch LP.

finally, through D/A conversion, back into a continuous audio waveform.

Since there is no physical contact between the pickup and the surface of the disc, the pickup must be guided by a dynamic-tracking servo system. The lack of physical contact also means that record wear is totally eliminated.

Unlike the turntables used to play today's analog records, the rotating platter that spins the C-DAD disc has a variable rotational speed—200 rpm when the laser is at the circumference of the disc and around 500 rpm when it is 50 millimeters from the center, the inner radial limit. Scanning takes place from *inside* to *outside* and rotation is *counterclockwise*. The total storage capacity of the C-DAD disc is over 8 billion bits per side—far more than is necessary for the 60 minutes of playing time that has been standardized for the disc. That provides a great many additional possibilities for designing C-DAD players. Both the Philips and Sony prototype players that were shown last spring (see Fig. 3) were able to "read out" such additional useful information as the number of the selection being heard, its length, the sequence of numbers programmed to be heard, etc. Owners of C-DAD disc players will be able to make use of sophisticated programming circuitry, enabling them to determine which songs they want to hear and in what sequence they want to hear them.

### Audio quality and performance

The frequency response of the sys-

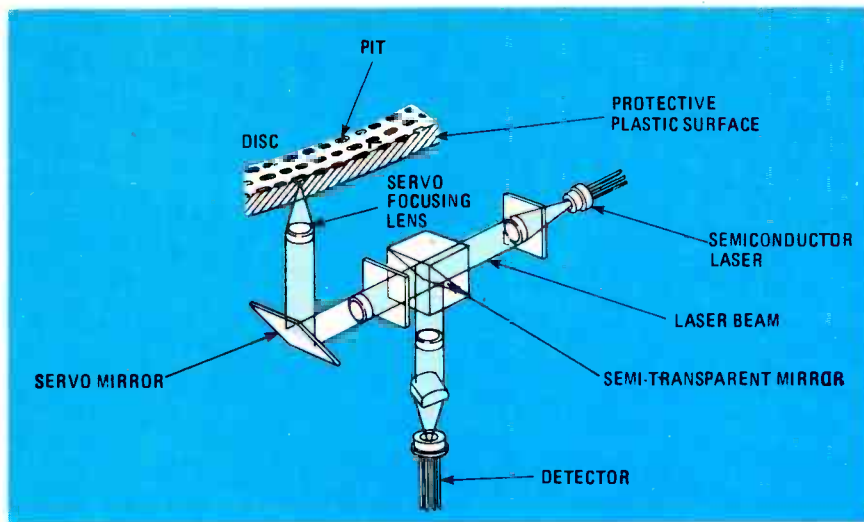

FIG. 2—THE C-DAD SYSTEM uses a tightly focused laser beam to read digital information represented by a series of pits on the disc.

TABLE 1

| Specification                  | C-DAD disc      | LP record          |
|--------------------------------|-----------------|--------------------|
| Frequency response             | 20–20,000 Hz    | 30–20,000 Hz       |
| S/N ratio                      | More than 90 dB | More than 60 dB    |
| Dynamic range                  | More than 90 dB | Max. 55 dB (1 kHz) |
| Channel separation             | More than 90 dB | 25–35 dB           |
| High-frequency distortion rate | Less than 0.05% | 0.2%               |
| Wow & flutter                  | 0%              | 0.03% (WRMS)       |
| Playing time                   | 60 Minutes      | 30 Minutes         |
| Disc diameter                  | 4.7 inches      | 12 inches          |

tem is absolutely flat from 20 Hz to 20,000 Hz. The digital sampling-frequency is 44.1 kHz, which would theoretically give a response up to 22.05 kHz. Some margin, though, is left for high-frequency cut-off filtering.

The signal-to-noise ratio for the 16-bit digitizing format is better than 90 dB (theoretically, it could be as high as 97.5 dB); dynamic range—the difference in level between softest and loudest sounds that can be handled—is also better than 90 dB. Channel separation is 90 dB as well, while total harmonic distortion, referred to peak levels, is 0.05% or less (0.03%, theoretical).

As with any true digital-sound system there is no measurable rumble or wow-and-flutter. Tracking, decoding, and rotational speeds are synchronized by a central clock generator inside the player and the clock is itself governed by information encoded in the track on the disc. Since the digital data representing the music is stored briefly in semiconductor memory in the player before being clocked out at a steady rate to the digital-to-analog converter, there can be no wow or flutter in the conventional sense.

There is also no audible intermodulation-distortion of the type that plagues conventional analog recordings to such a large degree. To fully appreciate the significance of these performance levels, see Table 1, which compares the

C-DAD system with conventional LP records.

### Competing digital-disc systems

Of the many digital-audio disc systems that have surfaced over the last several years, two besides the C-DAD system have been successfully demonstrated and been under consideration by a 51-member Digital-Audio Disc Council. That group deliberated about standardization for about three years

(and has only recently been disbanded) in Japan. The two other systems are:

1. A capacitance-pickup system, developed by JVC as an adjunct to its VHD videodisc system which is to be marketed in early 1982 and which has been given the name AHD (Audio High Density).
2. A mechanical "groove-type" system developed by Telefunken.

Discs for the variable-capacitance system (AHD) are made of conductive materials. As shown in Fig. 4, digital signals in the form of tiny pits are engraved in these discs. As a miniature metal electrode follows the pits, signals, represented by changes in electrostatic capacitance, are detected. To maintain the necessary accuracy, the pits are engraved on the surface of the disc along with pilot signals impressed on either side of the audio signal pits. Since there are no physical grooves impressed into its surface, the pilot signals are used as part of a dynamic-tracking servo system to keep the electrode stylus properly positioned along the signal track of the AHD audio disc.

In the mechanical system developed by Telefunken, playback is accomplished in a manner similar to that used by ordinary analog players (see Fig. 5). That is, signals cut into the grooves of the disc are first converted into mechanical vibrations as the stylus traces them and the vibrations are then transmitted through a pickup arm to a piezoelectric converter, where they are changed into electrical signals.

Table 2 offers a comparison of these two systems and the Sony-Philips C-DAD one. Of the three, only the Sony-Philips and the JVC systems seem likely to reach the marketplace in the near future. JVC's argument in favor of its system is based largely upon the fact that a single player would be able to



FIG. 3—C-DAD PLAYER prototypes shown in 1981. Sony's is at left; Philips' at right.



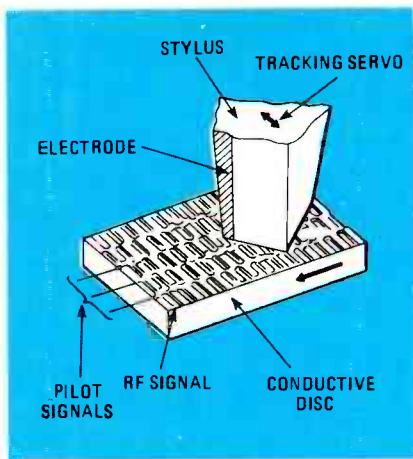

FIG. 4—JVC'S AHD digital-audio disc system works on the same principles as its VHD video-disc system.

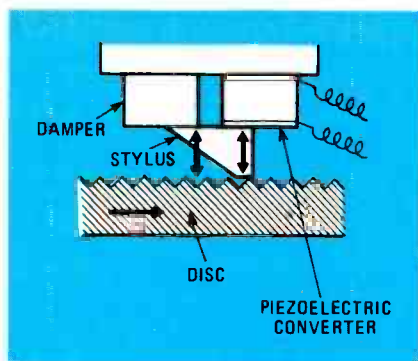

FIG. 5—THE MECHANICAL SYSTEM developed by Telefunken for digital discs is similar to that used for today's analog records.

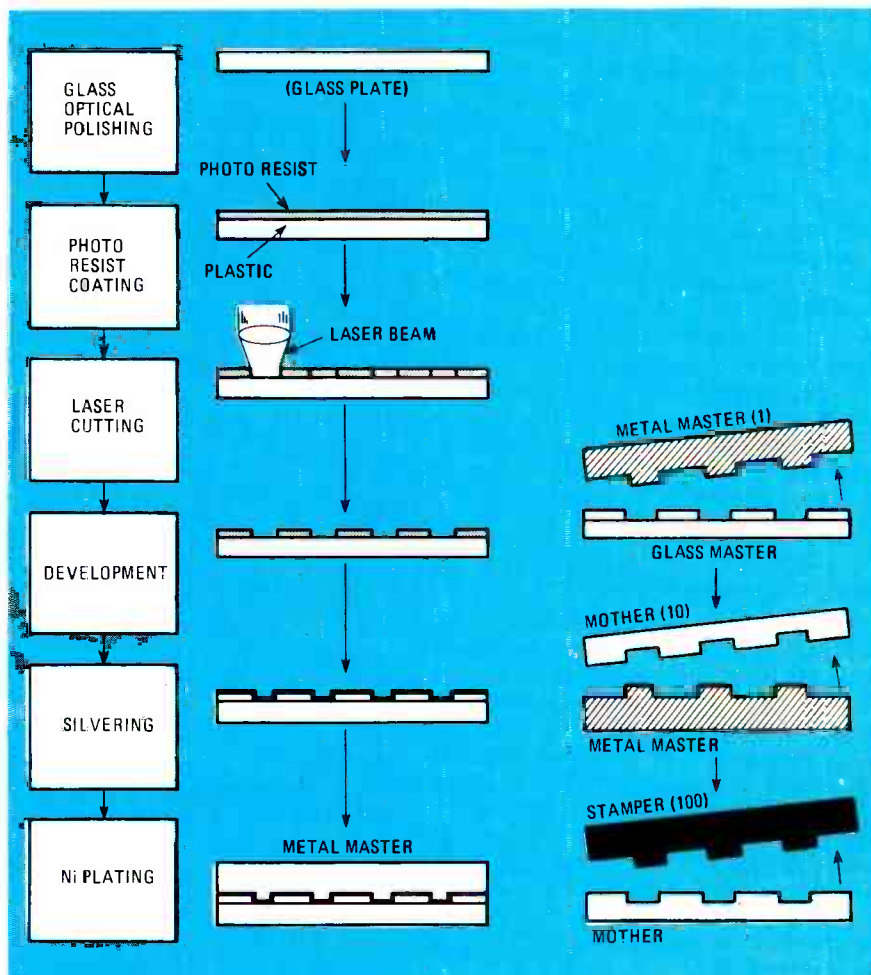

FIG. 6—STAGES INVOLVED in the manufacture of C-DAD discs. Numbers in parentheses at right indicate how many of each piece are produced.

TABLE 2

| Characteristics      | Sony-Philips            | JVC                      | Telefunken   |
|----------------------|-------------------------|--------------------------|--|
| Signal-pickup method | Optical                 | Capacitance              | Mechanical   |
| Pickup               | Non-contacting          | Contacting               | Contacting   |
| Signal location      | Beneath surface         | On surface               | On surface   |
| Grooves              | No                      | No                       | Yes  |
| Surface material     | Transparent plastic     | Carbon-impregnated vinyl | Various  |
| Disc caddy (holder)  | Not required            | Required                 | Required   |
| Disc size            | 120 mm                  | 260 mm                   | 135 mm<br>70 mm                                    |
| Playing time         | 60 minutes (2 channels) | 60 minutes (4 channels)  | 60 minutes (2 channels)<br>30 minutes (2 channels) |
| Format               | 16-bit                  | 16-bit                   | 14-bit   |

handle both its videodiscs (the VHD discs that are to be marketed in 1982) and the AHD digital-audio discs, since both use a capacitance-pickup principle. Of course, a digital-to-analog converter/processor would have to be added to the JVC system for decoding the digital-audio discs; the addition of such a D/A converter/processor would make the lower-cost argument somewhat questionable.

The JVC AHD disc, like its companion VHD disc, is a little over 10 inches in diameter and comes supplied in a "caddy" or holder that protects the

disc surface when it is not being played. The smaller, optically-tracked, C-DAD disc requires no such protective sleeve, of course, and is in no way affected by dirt or dust on its surface since the focal point of the laser beam is beneath the transparent surface of the disc. An important point that has been emphasized many times by Sony and Philips is that the small C-DAD disc and its correspondingly small player can easily be adapted for use in cars and other moving vehicles, since the vibration of a vehicle should have little or no effect upon laser tracking.

#### The trend towards C-DAD

There seems to be a growing trend towards endorsement of the C-DAD system by equipment manufacturers and "software" (recorded material) producers around the world. Matsushita Electric Company (whose line of brands includes Panasonic, Quasar, Technics and National), although committed to the JVC VHD system for videodiscs, has nevertheless indicated that it will produce disc players for the Sony-Philips system. Recently, the worldwide Polygram Group, one of the leading international record manufac-

turers, and CBS/Sony, Inc., the largest record company in Japan, announced plans to produce music programs in the C-DAD format. In 1982, for example, CBS/Sony will release more than 100 C-DAD albums in Japan simultaneously with the introduction of the C-DAD players. On the hardware side, companies such as Marantz have already demonstrated their own versions of players which are compatible with the Sony-Philips optical-laser disc system. And, while the 51-member Digital Audio Council mentioned earlier did not specifically endorse the C-DAD system, its final report noted its compact size and its applicability to mobile use, which many interpreted as being just about as close to an endorsement as such a committee would ever be likely to come.

### How C-DAD discs are made

Once you get past the hurdle of paying for a C-DAD optical-laser player (about the price of a high-end turntable), the software or discs themselves should be no more expensive, on a "per-minute-of-music" basis, than high-quality LP records. The process of making digital discs is quite different from the process currently used to make analog LP records, but once it has been mastered, it should be possible to turn out the new discs on a mass-production basis that will reduce disc prices drastically.

Mechanical cutting-techniques are impractical for digital-disc production because the pits to be carved are far too small. Instead, the process shown in Fig. 6 is used. First, a glass plate coated with photo-resist material is exposed to a digitally-modulated laser beam. The plate is then developed to form pits corresponding to the presence or absence of digital signals. After a silvering process, that glass plate becomes the "master."

It is next pressed against a nickel plate to make an inverse copy (the pits become small bumps and the flats become depressions) of the photo-etched depressions on that plate. A digital master is thus produced which, in turn, is used as the "mother" for making production "stamper." Each stage inverts the surface of the disc (pits-bumps-pits-bumps, etc.). The stamper has bumps.

The final production stages are shown in Fig. 7. Using the stamper, C-DAD discs are produced in large quantities in much the same manner as conventional analog records. The signal-bearing surface of each disc is then coated with a reflective material, followed by a coating of protective, transparent plastic. Aside from any labelling and packaging that may be required, that completes the manufacture of a single-sided disc.

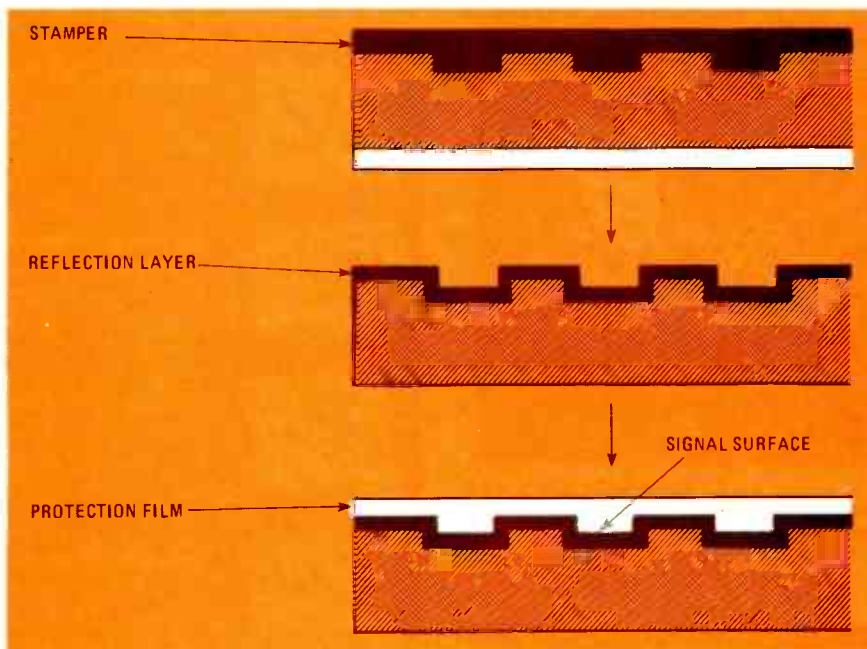

FIG. 7—FINAL STAGE in C-DAD disc production involves adding a reflective layer to the surface and protecting it with a clear plastic coating.

## “DIGITAL” vs. DIGITAL

FOR THE PAST SEVERAL YEARS 12-INCH “DIGITAL” discs have been available from companies such as Telarc, Teldec, London, and others.

It is a common misconception that those are *true* digital discs, but that is not the case.

*True* digital discs carry the audio information as a series of binary-coded numbers—that is the method used by the C-DAD.

*Digitally-mastered* discs—the 12-inchers currently on the market—are so called because the *master tapes* from which they are produced are digitally-encoded. The discs themselves carry a conventional analog signal.

Those discs do have an advantage over ones recorded using analog processes all the way through—the quality of the master tapes is higher and some of that quality is carried over into the analog pressing. Dynamic range is greater, tape hiss is non-existent, etc. The discs themselves, though, are still prone to the shortcomings of analog recordings—surface noise, restricted dynamic range, tracking problems, and so forth.

While “digital” (digitally-mastered) discs certainly represent a tremendous improvement over their all-analog predecessors, their quality is still far removed from that obtainable from all-digital recordings.

R-E

For a two-sided disc, an additional process to combine two single-sided discs would be required, but it is entirely possible to produce such two-sided discs.

### Digital source-material

Recognizing the advantages of digital recording almost as soon as it was made available on a commercial basis to recording studios several years ago, many recording companies around the world have been producing digital master-tapes for release as digitally-mastered, improved *analog* LP's (often erroneously referred to as “digital” records). Although many of those recordings have been praised as being clearly superior in sound quality to conventional LP's, they obviously cannot approach the performance levels that will be reached by C-DAD discs once they are made available. (See sidebar for more information.)

The fact that so many digital master tapes now exist in the archives of major recording studios bodes well for the future of true digital-discs. All those tapes can be used to make true digital-audio discs, with no degradation in quality from master tape to disc. The Sony-Philips system, in fact, uses the same 16-bit PCM (Pulse Code Modulation) encoding currently being used for professional digital-audio purposes. Therefore, C-DAD recordings can be made in studios using existing PCM equipment. It is also possible to translate existing analog recordings, using PCM processors, to the C-DAD format. However, should that be done, the resulting product would not exhibit the increased dynamic range and other improvements made possible by digital-recording technology.

R-E



# TELEVISION

## WHAT EVER HAPPENED TO CHANNEL 1?

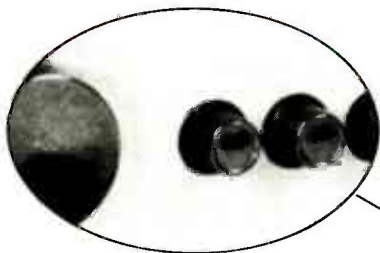

Ever wonder why your VHF-television dial starts with Channel 2? Find out why in this brief look at the early days of television and how it all began.



DAVID A. FERRE

WHEN A TELEVISION RECEIVER IS PURCHASED in the United States, you can take it anywhere in the country, plug it in, pull up the "rabbit ears," and tune in a station. That is possible because we have national broadcasting standards that are common throughout the country. Yet, at one time commercial television was going to be introduced to the American public without standards; fortunately, that "experiment" ended before it even started. But let's not get ahead of our story!

### Up to 1934

During the first few months of 1933, RCA demonstrated the first successful all-electronic television system. Broadcasts were made from the RCA experi-

mental television transmitter, W2XBS, located at the top of the Empire State Building in New York City. The characteristics of that early all-electronic television system were modest:

- Lines: 240
- Frames: 24 per second
- Scanning: sequential (no interlacing)
- Bandwidth: 2 MHz
- Video carrier: AM modulated, full sideband
- Audio carrier: AM modulated, full sideband

Yet, the results were far better than any mechanical television system had ever accomplished. For those experiments, the video carrier was at approximately 45 MHz.

It may be hard for us to appreciate

fully what RCA had accomplished in 1933. But to give you an idea: Many of the experimental television broadcasters were still using frequencies in the 2- to 3-MHz range, and bandwidths of 100 kHz. In addition, the earlier systems were mechanical using gears, motors, mirrors, etc. As television advanced, each step pointed towards non-mechanical systems, and higher bandwidths and carrier frequencies.

The Federal Communications Commission was established by an act of Congress on June 22, 1934. It was about that time that a portion of the VHF radio spectrum was allocated to television for the first time (see Fig. 1). Previously, any frequency above 30 MHz was available to experimenters. Those experimenters included a number of pioneering amateur-radio operators; there were also experimental stations that included television. In 1934, the experimenters were moved to the frequencies above 110 MHz, while television was allocated two bands, 42-56 and 60-86 MHz. There were no channels associated with the allocations, but it was a beginning; television was making its first move.

### 1934 to 1938

Progress was slow for television during those years. The depression was at its worst, and even mighty RCA lost

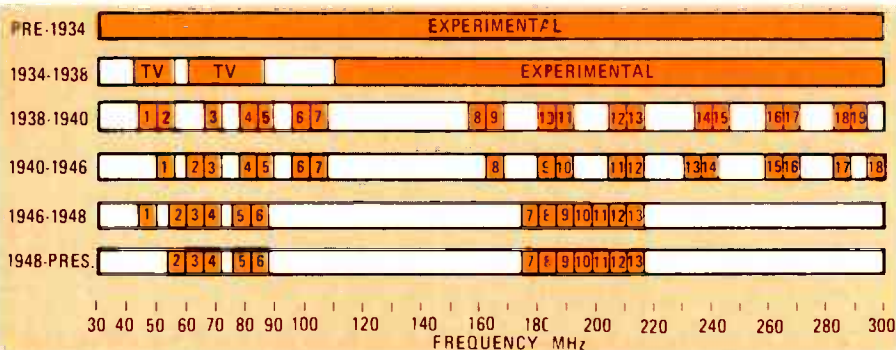

FIG. 1—HOW THE TELEVISION ALLOCATIONS have changed over the years. This chart shows the approximate frequencies of the channels; the exact frequencies are given in Table 1.

money. But advances were made in RCA's all-electronic system. In June, 1936, RCA announced the start of a massive field test. A total of 100 experimental-television receivers were distributed to RCA employees for placement in their homes and offices (see Fig. 2). RCA then began regular television broadcasts from W2XBS, using their new Radio City television studios. Those studios were linked to the Empire State Building transmitter by an experimental 177-MHz radio link and a coaxial cable. The composition of the television signal used for that test was as follows:

- Lines: 343
- Frames: 30 per second
- Scanning: interlaced (2:1)
- Bandwidth: 5.75 MHz
- Video carrier: AM modulated, full sideband
- Audio carrier: AM modulated, full sideband

On June 15, 1936, the FCC began informal hearings concerning the radio spectrum above 30 MHz. There was an increasing demand for those frequencies and a new word began to be heard at the FCC; that word was standards. The Radio Manufacturers Association (RMA), the trade association for the radio and television equipment manufacturers, had formed a sub-committee on television. They attended the June, 1936 hearings because of their interest in the possible future commercialization of television. In addition to urging definite channel allocations, the RMA had a set of television channel standards to present (see Fig. 3-a). Although those standards were incomplete in some respects, one important recommendation that the RMA made to the Commission was that the bandwidth of a television channel should be 6 MHz—the same bandwidth that is used today. The RMA television standards were:

- Lines: 441
- Frames: 30 per second
- Scanning: interlaced (2:1)
- Bandwidth: 6 MHz
- Video carrier: AM modulated, full sideband
- Audio carrier: AM modulated, full sideband

It is interesting to note that the proposed 441-line standard was beyond the capabilities of any system that had been demonstrated up to that point. It wasn't until eight months later, on February 11, 1937, that a manufacturer (Philco) gave a convincing demonstration of a television system that completely met the RMA standards.

The FCC hearings that had started on June 15, 1936, resulted in the allocation of 19 television channels, each with a bandwidth of 6 MHz. The new allocations, which are shown in Fig. 1 and Table 1, became effective October 13, 1938. The RMA revised and completed their set of television standards, which were essentially the same as the 1936



FIG. 2—ONE OF THE LAST in existence, this receiver was one of the ones used in RCA's test of the first all-electronic television system. The vertically-mounted picture tube was viewed through a mirror in the cabinet top.

standards except for one important difference: The video carrier would now be transmitted with a full upper sideband and only a partial lower sideband, as shown in Fig. 3-b. That vestigial sideband system was eventually adopted by the FCC and is used today.

Television now had allocations and channel numbers. Our mysterious Channel 1 was assigned to the 44- to 50-MHz band as shown in Table 1. RCA's experimental station quickly received a permit for one of those new television allocations and selected Channel 1!

### 1938 to 1940

The television industry was generally pleased with the FCC allocation of 19 TV channels. They were hoping for a continuous band of frequencies to simplify tuner design, and were somewhat disappointed that 12 of the 19 channels were above 150 MHz; those frequencies were virtually unused, and thought to be useful only for television-relay networks. But the seven channels between 44 and 108 MHz were enough to begin plans for commercial television operation. By then it was believed that the RMA standards would be adopted by the FCC and commercialization could begin. But not everybody agreed with the RMA standards, and the FCC wasn't about to approve any standard unless the television industry was in almost total agreement.

On October 20, 1938, just one week

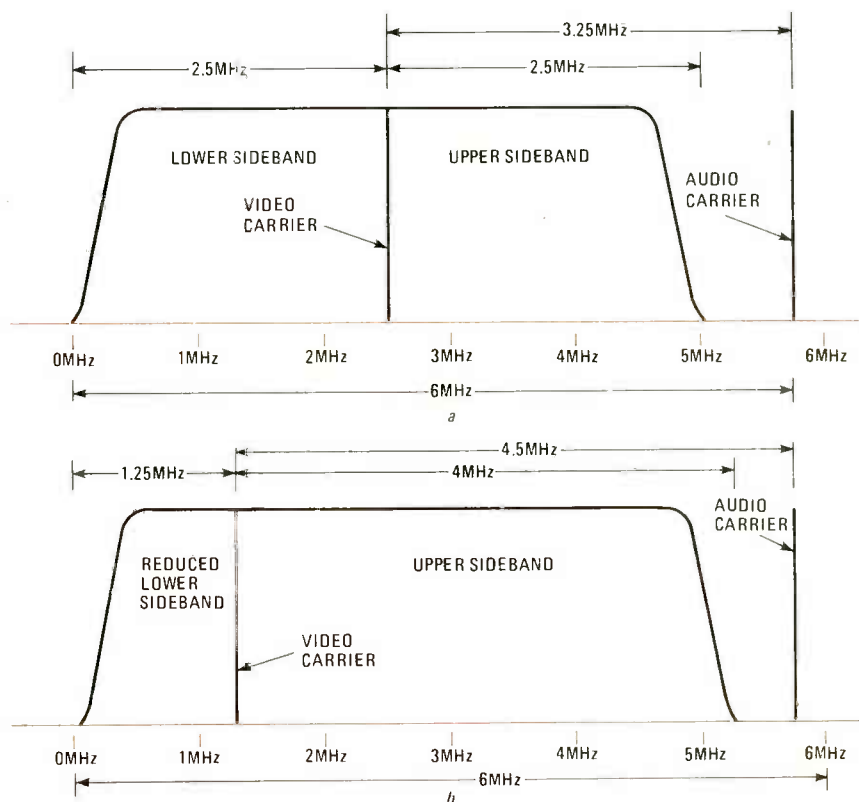

FIG. 3—THE FIRST STANDARDIZATION of a television signal, the system shown in a featured full upper and lower sidebands. A later revision, shown in b, featured a reduced lower sideband. That vestigial sideband technique is the one is use today.



TABLE 1

| Channel | Year      |           |           |              |
|---------|-----------|-----------|-----------|--------------|
|         | 1938-1940 | 1940-1946 | 1946-1948 | 1948-PRESENT |
| 1       | 44-50     | 50-56     | 44-50     | —            |
| 2       | 50-56     | 60-66     | 54-60     | 54-60        |
| 3       | 66-72     | 66-72     | 60-66     | 60-66        |
| 4       | 78-84     | 78-84     | 66-72     | 66-72        |
| 5       | 84-90     | 84-90     | 76-82     | 76-82        |
| 6       | 96-102    | 96-102    | 82-88     | 82-88        |
| 7       | 102-108   | 102-108   | 174-180   | 174-180      |
| 8       | 156-162   | 162-168   | 180-186   | 180-186      |
| 9       | 162-168   | 180-186   | 186-192   | 186-192      |
| 10      | 180-186   | 186-192   | 192-198   | 192-198      |
| 11      | 186-192   | 204-210   | 198-204   | 198-204      |
| 12      | 204-210   | 210-216   | 204-210   | 204-210      |
| 13      | 210-216   | 230-236   | 210-216   | 210-216      |
| 14      | 234-240   | 236-242   | —         | —            |
| 15      | 240-246   | 258-264   | —         | —            |
| 16      | 258-264   | 264-270   | —         | —            |
| 17      | 264-270   | 282-288   | —         | —            |
| 18      | 282-288   | 288-294   | —         | —            |
| 19      | 288-294   | —         | —         | —            |

after the allocations became effective, RCA announced that regular television programming would begin as a "public service" on April 30, 1939. That date coincided with the opening of the 1939 New York World's Fair. A number of manufacturers began producing television receivers, and by the opening of the fair they were in the stores and ready for sale. The opening ceremonies of the fair were broadcast on Channel 1 by RCA's W2XBS, and featured the President of the United States. After that event, broadcasts were scheduled on a regular basis.

By the end of May 1939, large department stores, such as Macy's in New York, offered as many as nine different models for sale; those were supplied by three manufacturers (Andrea, DuMont, and RCA). Screen sizes for those television sets ranged from 5 to 14 inches, and prices ranged from \$189.50 to \$600.00. Most of the early sets were complete receivers, but one, the *model TT-5* from RCA (shown in Fig. 4), had no audio section; if audio was desired, it had to be connected to a compatible RCA receiver. Unfortunately, sales of those early television sets were not very good, and by the end of 1939 fewer than 400 of them had been sold in the New York area.

All of the major television broadcasters (incidentally, the stations were still considered experimental) had adopted the RMA standards by the end of 1939. That included the stations in New York City, Chicago, Los Angeles, and Schenectady. The FCC was urged to adopt the RMA standards so that commercialization could begin. The FCC responded to the pressure from the TV industry by publishing rules for limited commercialization on December 22, 1939. It was a kind of Christmas present for the television industry.

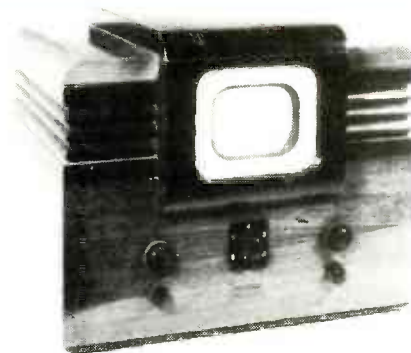

FIG. 4—THIS EARLY TELEVISION SET, the RCA *model TT-5*, was one of the first offered for sale to the general public. It featured a five-inch screen, five-channel coverage, but no audio section; it sold for \$199.50 in 1939.

At the time those rules were published, the FCC also announced that hearings would be held in January, before establishing a date for limited commercialization. At those hearings, it was made clear to the FCC that many of the broadcasters did not agree that the RMA standards were the best. Philco urged the FCC to adopt their system of television with 605 lines and 24 frames-per-second. DuMont wanted standards that included 625 lines and 15 frames-per-second. In addition, there was some vague talk about something called color television. Nevertheless, in an order issued on February 29, 1940, the FCC ruled that limited commercialization could begin on September 1, but warned that nothing should be done to encourage a large public investment in television receivers. They refused to adopt any standards, with the implication that each of the broadcasters could use whatever standards they liked best, with the public deciding who had the best system.

RCA responded to the authorization for limited commercialization with full-

page newspaper ads in early March announcing the "arrival of television," and ordered the immediate production of 25,000 television receivers. The FCC realized that limited commercialization wasn't going to work, as the sale of thousands of television sets would, in effect, "freeze" the standards, making a change to other standards almost impossible. Within a few days of the RCA newspaper ads, the FCC's permission for limited commercialization was withdrawn.

Television was also about to undergo some more changes. Frequency Modulation (FM) had been introduced by its developer, Major Edwin H. Armstrong, in 1935. Shortly after its introduction, FM was granted five experimental frequencies between 42.6 and 43.4 MHz. By 1940, the FCC had 150 applications for experimental FM stations on file that could not be processed because of lack of frequencies. As a result of hearings held on March 18, 1940, the FCC assigned FM a continuous band of frequencies (that was done to simplify tuner design), and expanded the FM allocation to include the frequencies from 42 to 50 MHz. The new allocation included the 44- to 50-MHz band that had previously been assigned to Channel 1.

But that is not what happened to Channel 1! The TV channels were renumbered with Channel 1 now assigned to 50-56 MHz band and the remaining channels were shifted around the spectrum. But when the smoke cleared, the television industry had lost one channel, leaving them with 18 allocations.

The new FM channels and the changes in the television allocations became effective on June 20, 1940; commercial FM broadcasting was authorized to begin on January 1, 1941.

#### 1940 to 1946

When the revised 18-channel TV allocations went into effect, the television industry was unhappy, to say the least. The limited commercialization plan was suspended; the FCC continued its refusal to set television standards; a television channel was lost to FM, and, because of the changes in the allocations, many of the experimental TV broadcasters had to go off the air to complete extensive transmitter changes. For example, the RCA experimental transmitter, W2XBS, had been operating on the old Channel 1 (44-50 MHz); because of the changes, they were forced to switch to the new Channel 1 (50-60 MHz).

However, soon after that things began to look up. A member of the RMA had met with the FCC to ask just what the television industry could do to win approval of a set of standards. The FCC replied that if the industry could agree on *one* set of standards, they would be

approved without delay. Quickly, the RMA organized the National Television Standards Committee (NTSC). The NTSC was open to all major interests in the television field whether they were associated with the RMA or not. Eventually, over 160 individuals became associated with the NTSC. On July 31, 1940, under the RMA's sponsorship and with the FCC's blessing, the NTSC held its first meeting.

With the opportunity to propose a set of standards to the FCC, you might have expected that the NTSC would simply have endorsed the existing RMA standards, but that is not what happened. Every aspect of the television-standards question was re-examined and discussed at length. On January 27, 1941, the NTSC met with the FCC and presented a progress report. The preliminary NTSC standard presented to the FCC at that meeting closely paralleled the RMA standards. That seemed to indicate that the RMA standards were essentially correct. There was one important difference, however: The audio carrier was to be FM. The FCC had one reservation about the proposed standard—they felt that the 441-line standard recommended by the NTSC was too low. That standard went way back to the first RMA standards of 1936, when both video sidebands were transmitted. It was common knowledge that the vestigial sideband system in use since 1938 allowed a much higher line count and, accordingly, a better television picture. The NTSC agreed to re-examine that question and said that it would present more information at hearings that were to be held in March, 1941.

Those hearings were held on March 20, 1941. The NTSC standard that was presented at the hearing was almost identical to the one proposed earlier, except that the number of lines was increased to 525 lines. (Although the number of lines seemed to be random, it was not. The line count had to be an odd number and to be related to few multiples of odd numbers, such as  $3 \times 3 \times 7 \times 7 = 441$  or  $3 \times 5 \times 5 \times 7 = 525$ , for example. That was necessary for generation of the synchronizing pulse.) The new standard was as follows:

|                |   |
|----------------|---|
| Lines:         | 525   |
| Frames:        | 30-per-second   |
| Scanning:      | interlaced (2:1)  |
| Bandwidth:     | 6 MHz   |
| Video carrier: | AM modulated, vestigial sideband                                    |
| Audio carrier: | FM modulated, $\pm 75$ kHz deviation (later $\pm 25$ kHz deviation) |

Virtually all of the participants in the hearings (they went on for four days) agreed that the NTSC Standards were correct and should be adopted quickly. The FCC was convinced that the indus-

try had finally agreed and the NTSC Standards were adopted as the national standard in April 1941. The effective date was July 1, 1941; commercial television could finally begin!

When that "Opening Day" for commercial television finally arrived, only two television stations were licensed and ready for operation; WNBT (NBC, old W2XBS) transmitting on Channel 1, and WCBW (CBS, old W2XAX) transmitting on Channel 2. Both of those stations were in New York City. Soon after (on September 1, 1941) WPTZ in Philadelphia, transmitting on Channel 3, came on the air. By the spring of 1942, a total of four commercial stations were in full operation and 10,000 television receivers had been sold.

Television's growth was halted by World War II, with the Defense Communications Board ordering the construction of new radio and television stations to end. Television programming was reduced to just four hours per week for the broadcasters already in operation (all devoted to war-related activities).

As the end of the war approached, the FCC was faced with a monumental task. The war effort had brought about an extraordinary leap in communications technology. Frequencies that had been thought to be useless were now in tremendous demand. The entire spectrum had to be re-examined, with new allocations made and old ones revised. The FCC began by holding hearings on September 28, 1944. They were promptly overwhelmed. The 18-channel television allocations in effect since 1940 were attacked by one group as being wasteful of the valuable VHF spectrum, yet another group urged an increase to 26 channels. Others urged the FCC to move all of the television allocations to UHF frequencies immediately. But the television industry argued that television had waited long enough and should develop now, using the existing allocations.

After hearings that were held on February 14, 1945, it became clear that no group was going to get everything it wanted. In the FCC's final decision, released on June 27, 1945, television's allocation was reduced to 13 channels, and FM was moved from the 42-50 MHz slot to 88-106 MHz (the band was later increased to 88-108 MHz). The television interests were very unhappy that they were left with only 13 channels, but the FM interests suffered a major blow because all of the existing stations had to go off the air and switch to new frequencies. In addition, 500,000 home-FM receivers were now obsolete.

The reduction to 13 television channels was accompanied by new and re-organized frequency allocations (see Table 1). Again the broadcasters had to go off the air to switch frequencies.

Our Channel 1 was still around, but it was moved back to the 44- to 50-MHz band that it had occupied from 1938 to 1940. In addition, there was a restriction for Channel 1: It could only be assigned as a community channel, and was limited to a maximum power of 1000 watts. Other TV channels were for metropolitan stations, with a maximum power of 50,000 watts permitted. All channels, except Channel 6, were shared with fixed and mobile services—a fact that left the television interests concerned about interference. The changes became effective March 1, 1946.

### 1946 to 1948

Even with the reduced number of channels, the boom was on! Manufacturers quickly began producing television receivers, transmitters, antennas, etc. New television stations were being built all over the United States. The FCC had identified the top 140 metropolitan cities and assigned each at least one channel; a total of 400 were to be allotted. The FCC received many more applications than it had available channels. In an effort to provide the public with as many channels as possible, the FCC routinely threw away the "safety factor" of mileage between licensed transmitters. Television-receiver sales were doing very well, with 175,000 sold by the end of 1947. Manufacturers were selling television sets as fast as they could be made, even though the sets were rather expensive. (A typical set with a 10-inch screen sold for \$375.)

But problems began to appear. Propagation theories at that time predicted that television signals would not be received over the horizon—but they were, quite readily. So, even with just 50 stations on the air, interference problems were beginning to appear. Meanwhile, the FCC had reduced the minimum distance between stations using the same channel to just 80 miles. An engineering study released by the FCC warned of interference problems if immediate action wasn't taken. That led to an FCC report, issued on May 5, 1948, that ruled that television could no longer share its frequencies with fixed and mobile services, and that the 72- to 76-MHz band could be used for fixed radio services only.

But where could the mobile services be located if they could no longer share the television allocations, and could no longer use the 72- to 76-MHz band? There was only one place to go—the television industry would have to give up another TV channel. But which channel would that be? The American Radio Relay League (an association of amateur radio operators) urged that Channel 2 be deleted so that the second harmonics of the 28-29.7-MHz amateur-radio band would not interfere with

*continued on page 89*



TRAFFIC BROADCAST ZONES  
IN WEST GERMANY (ARI)

## NEW USE FOR FM SCA AUTOMATIC ROAD INFORMATION SYSTEM

*Most people think of SCA as a means of piping mood music into stores and restaurants. West Germany has found a much more valuable way to use that service.*

LEN FELDMAN  
CONTRIBUTING HI-FI/VIDEO EDITOR

A FEW YEARS AFTER MAJOR ARMSTRONG FIRST DEMONSTRATED a workable system of wideband-FM radio broadcasting back in the 1930's, he demonstrated how a subcarrier could be used to modulate the main carrier of an FM station, and how that subcarrier could carry information that was totally different from what was being transmitted on the main carrier.

Many years later, in 1961, the basic techniques developed by Armstrong and modified by others resulted in the beginning of stereophonic broadcasting in the U.S., using subcarrier techniques which, though somewhat different from those first proposed by Armstrong, nevertheless fall into the general category for multiplexed FM.

### SCA

In 1954—several years before stereo broadcasting began—the Federal Communications Commission, concerned over

the increasing economic plight of struggling FM stations, authorized what came to be known as SCA transmissions. (SCA stands for Subsidiary Communications Authorization.) In those pre-stereo days, FM stations were permitted to transmit one or more subcarriers at frequencies between 25 kHz and 75 kHz above the main carrier, and to modulate those subcarriers with virtually any sort of useful information for use on a point-to-point basis. In other words, the station could lease its subcarriers to companies. The companies leasing the subcarriers could then charge a rental fee for receivers provided to subscribers who wanted to hear whatever was being transmitted on the subcarriers.

The best known use of those subscriber-oriented services is for commercial-free background music. Such music, brought to us by such familiar names as Muzak, has been the butt of jokes and disparaging remarks almost from the day that SCA service began. Less familiar is the fact that SCA transmissions do not always consist of background music. In many parts of the country, SCA channels are used to provide a "talking book" service for the blind. And, with the shortage of regular radio-channel space becoming acute, some enterprising broadcasters are turning to SCA to provide foreign-language or ethnic programming for audiences whose numbers are too small to justify the assignment of a station-frequency by the FCC.

With the advent of FM stereo in 1961, the space available for SCA channels was sharply reduced. Figure 1 shows the modulation spectrum of an FM-stereo transmitter. All of the frequencies given in the following discussion are referenced to the main-carrier frequency. The sum (L+R) of the two audio channels occupies spectrum space from 30 Hz to 15 kHz (the highest audio frequency permitted on FM), the stereo pilot-signal is found at 19 kHz, and the sidebands of the suppressed-carrier 38-kHz AM subcarrier signal containing the difference (L-R stereo information) occupy the space from 23 kHz to 53 kHz. That leaves only the spectrum space from 53 kHz to 75 kHz for SCA or private subcarrier use. Some guard-band space must be provided for, so the first practical subcarrier will have a frequency of around 57 kHz. Stations transmitting in stereo and also providing an

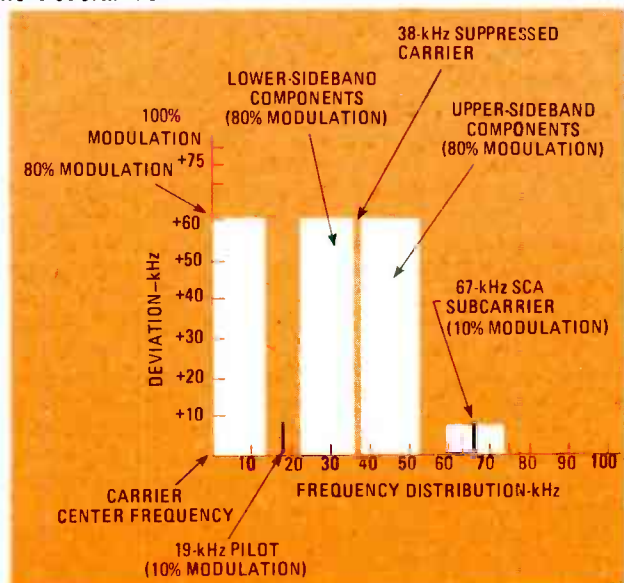

FIG. 1—AN FM-STEREO STATION that offers an SCA service does so at a frequency 67 kHz above the center frequency of its carrier.

SCA service generally select 67 kHz as their subcarrier frequency.

### Auto road information

We recently learned about a new use for SCA, which is currently in service in West Germany. The new service is helping to solve road problems in that country. As most drivers know, there are AM and FM radio stations in almost every part of this country that broadcast traffic information as part of their regular programming. The same is true in West Germany and in other European countries. But the high density of traffic in Europe has caused problems that did not exist even a few years ago.

The traffic problems, of course, are worst during rush hours, weekend peaks, vacation periods, etc. When the capacity of a road is exceeded, traffic jams occur, leading to road accidents—rear-end collisions and the like. The authorities in West Germany reasoned that information supplied promptly to drivers would help keep traffic problems to a minimum. Indeed, way back in the 1960's the government-controlled Radio Broadcast Network began giving traffic information at the end of hourly news broadcasts. It was quickly realized, however, that even such an expanded information service would be of little use unless the information were of a local nature (so that drivers in the immediate area of a problem were informed of it), and unless drivers could be readily alerted to the problem.

As early as 1969, West Germany's well known Blaupunkt radio company began working on the problem and came up with a system that made it possible to distinguish a station that broadcast traffic news and information from the many other stations on the FM broadcast band. Some time later, that system was elaborated upon and became known as ARI (Automatic Road Information). After extensive testing, the system was adopted in West Germany in 1974, and is in use today. Since then, the system has been submitted to the European Broadcasting Union (EBU) for adoption as a standard and, after practical tests in Switzerland, has been recommended to all European countries for the dissemination of traffic information. Austria introduced the system in 1976, and trials in other European countries have also been taking place to assess ARI's merits.

### The ARI system

The ARI system is used to identify stations that broadcast information about traffic conditions, as opposed to those that do not. That is especially useful to a driver who comes from another geographical area and is not familiar with local stations. Using a specially designed, ARI-equipped, radio, the driver can "tune out" stations that do not broadcast traffic information, leaving only the traffic-information stations audible.

One option in an ARI-equipped car radio automatically increases the volume to a predetermined level at the start of any traffic announcement, and returns it to its previous level at the conclusion of the announcement. Another option available in ARI-equipped radios provides a visual indication (similar to the familiar stereo-indicator light) when the driver tunes to a "traffic information" station. It is also possible to have traffic announcements override a cassette-tape program that the driver may be listening to while driving, with automatic return to the cassette when the announcement has been completed.

Still another version of the ARI-equipped radio provides an advance warning that a traffic announcement is about to be made, using a brief "signature tune" to avoid startling a driver whose radio had been muted before the announcement. A suitably equipped ARI car radio can even warn a driver when a station's signal strength falls below usable levels as he leaves the station's area of coverage. That is useful as it will allow him to tune to another ARI-equipped station in his new region of travel.

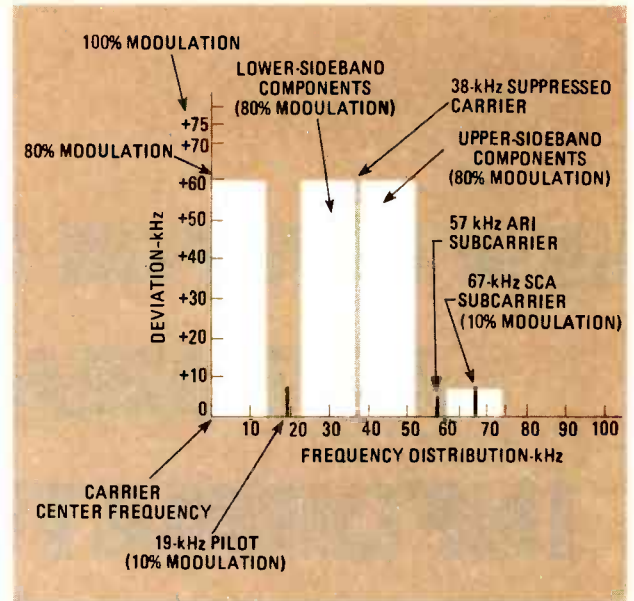

FIG. 2—THE ARI SYSTEM adds a 57-kHz subcarrier to indicate the presence of an ARI station.

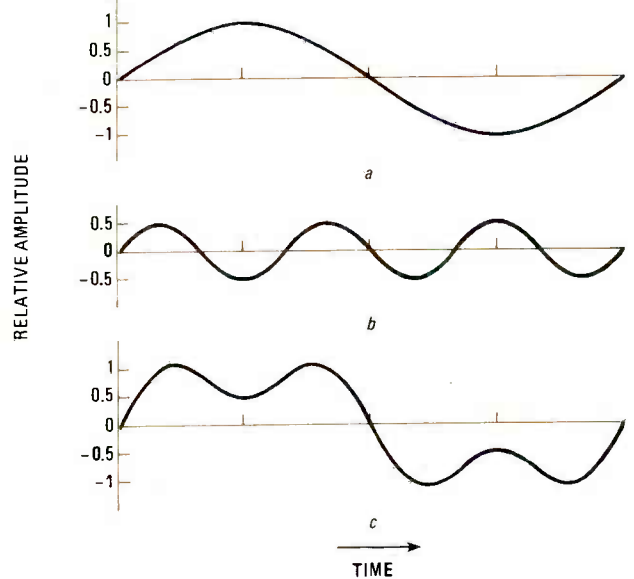

FIG. 3—THE PEAK AMPLITUDE of the 19-kHz stereo pilot-signal plus the 57-kHz ARI subcarrier does not exceed that of the pilot signal alone.

### How ARI works

An important characteristic of the ARI system is its ability to identify the station or stations in a given area that provide traffic information on a regular basis. Ordinarily, a driver would find it difficult and time consuming to single out a traffic-news station from all the others on the FM band in most metropolitan regions. With the ARI system, those stations that broadcast traffic information and are part of the ARI network transmit a continuous 57-kHz sub-carrier signal, known as the Station Identification signal (or "SK," from the German word "Senderkennung"). That signal, nestled between a normally used 67-kHz SCA subcarrier, and the upper frequency of 53 kHz that is present during FM-stereo broadcasts, is derived by tripling the 19-kHz pilot signal associated with stereo transmissions. The 57-kHz signal is therefore locked to the stereo pilot-signal both in phase and frequency relationship.

The complete modulation spectrum of an FM transmitter operating in both stereo and ARI is shown in Fig. 2. Figure 3 illustrates an important aspect of the ARI system. The 57-kHz subcarrier modulates the main carrier at half the level that the



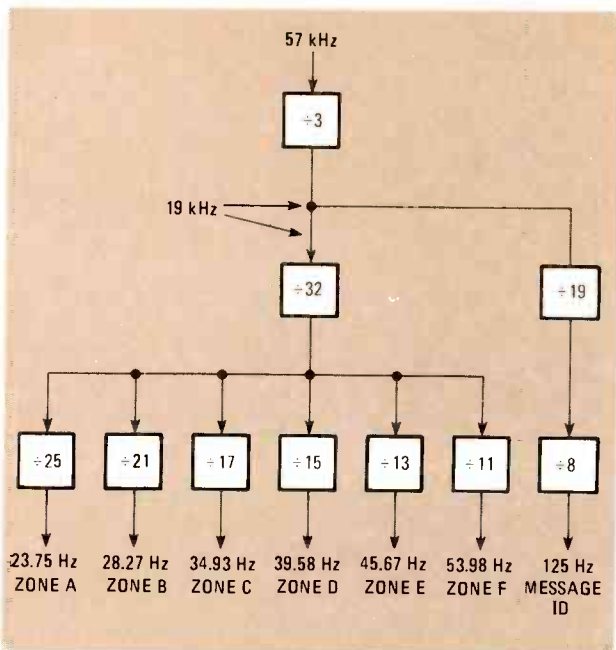

FIG. 4—ALL THE FREQUENCIES AND TONES used in the ARI signal are derived from the 19-kHz stereo pilot-tone.

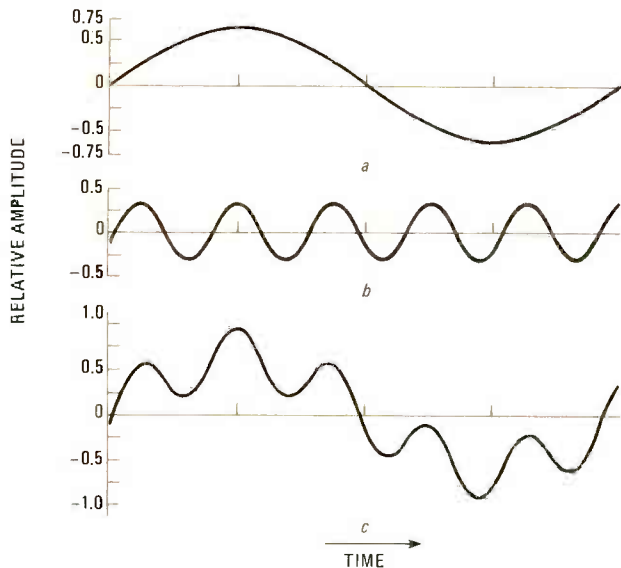

FIG. 5—ZONE-IDENTIFICATION TONE (a) is added to message-identification tone (b) to produce complex waveform (c).

19-kHz pilot signal modulates the main carrier, or between four and five percent of total modulation. The waveform shown in Fig. 3-a represents the amplitude of the 19-kHz pilot signal, while the one in Fig. 3-b is a representation of the 57-kHz ARI station-identification signal (the third harmonic of 19 kHz). Figure 3-c shows the algebraic addition of the two signals and it is clear that the peak amplitude of the resulting waveform is never greater than that of the original pilot signal. Thus, the combination of the pilot signal and the station-identification signal does not increase the frequency deviation of the main carrier. That also means that signal-to-noise ratios and station coverage-areas are not affected by the addition of the station identification signal.

#### Area identification

The limited range of FM transmissions presents both advantages and disadvantages in a traffic-information system such as that. On the one hand, drivers can be certain that the traffic information they receive applies to the region in which

they are. But it is also possible that, in certain areas, they would be able to receive more than one traffic-news station. A driver would want to be sure that he had selected the right station.

To solve that problem, Blaupunkt developed a special zone-indicating system for ARI. The total area to be covered is divided into traffic areas that correspond closely to areas covered by local radio stations. As many as six different zone identifications can be used, designated by the letters "A" through "F."

Each zone is assigned a very-low-frequency tone, which is used to modulate the 57-kHz ARI subcarrier, as shown in Fig. 4. Extensive measurements and field observations have shown that no audible interference occurs as a result of that added modulation. Zone or area identification frequencies are derived by dividing down the 19-kHz pilot tone; the values used in performing the division are also shown in Fig. 4. Depth of modulation of the 57-kHz ARI subcarrier signal is limited to just 60%.

#### Traffic message signals

While many drivers want to stay tuned to traffic-news stations throughout their travels, there are others who would prefer to hear only the traffic announcements but not the rest of the program material. For example, they might wish to converse with fellow passengers, preferring to keep the radio's volume level low, or to listen to a cassette tape for part of their trip, even though their car radio remained tuned to an ARI station.

For that reason, it was decided to use a seventh low-frequency tone, at a frequency of 125 Hz, to modulate the 57-kHz subcarrier and serve as a message-identification signal. The modulation level of that extra signal is set at half the value used for zone-identification tones and the tone is transmitted for the entire duration of the traffic message. Figure 5 shows how the modulating frequency of a zone or area identification adds to the 125 Hz "message identification" modulating frequency, with the latter having 50% of the amplitude of the former.

An important advantage of the ARI system is that all of the tones it uses, as well as the basic 57-kHz subcarrier itself, are derived from the stereo pilot-frequency through division or multiplication of the 19-kHz stereo pilot signal. Because of that relationship to the 19-kHz stereo pilot-signal, the design of the ARI radio receiver is greatly simplified.

#### What's available

The simplest and least expensive type of ARI receiver is one in which only traffic-news station-identification is used. In that type of receiver, an indicator light comes on when the driver tunes to a traffic-information station. If he wishes, he can push a button to mute all other stations, allowing only the ARI-equipped one(s) to come through. A somewhat more sophisticated receiver is one that combines station identification and message indication. Still another type can interrupt the playing of a tape cassette when a traffic message begins, switching to FM reception for the duration of the message, and then switch back to the cassette.

The ultimate ARI system uses a car radio with signal-search capability combined with an ARI circuit. The signal-search feature is designed to stop only at traffic-information stations and, when leaving the area of the local transmitter, it automatically searches for another traffic-information station. If, having left one zone and entered another, no other station with the same identification letter can be received, a warning tone informs the driver that a new zone-letter should be selected.

Reports from West Germany indicate that the ARI system has proven to be of great benefit. With all industrialized countries looking for unused communications channels, SCA frequencies offer a convenient means for providing new and innovative forms of point-to-point communications. R-E

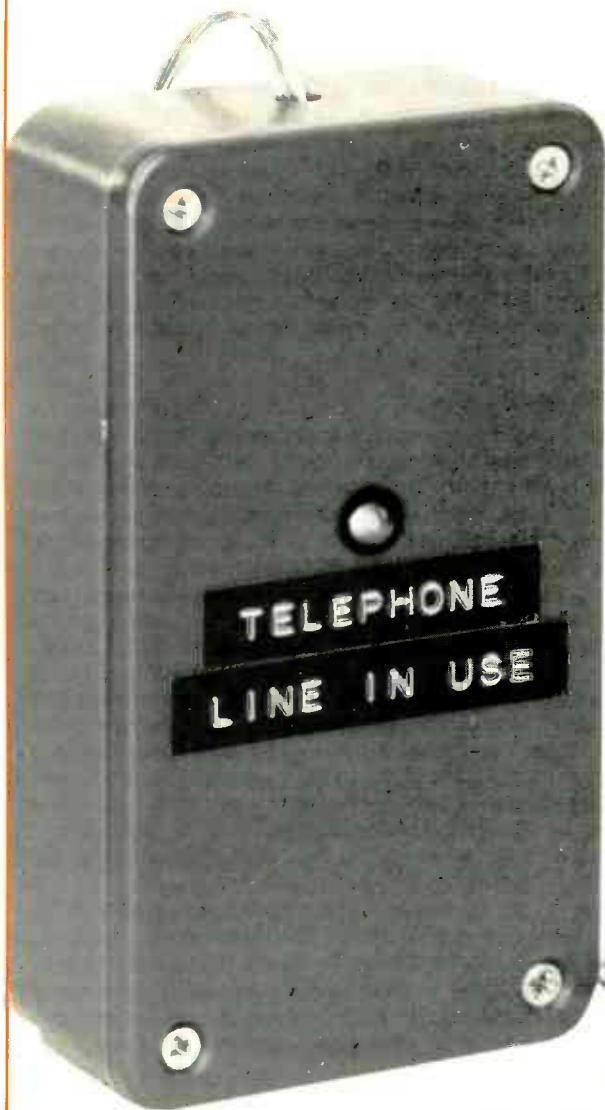

CHRISTOPHER M. DUNN

EVER PICK UP THE EXTENSION PHONE IN your home, only to find out that the line is already in use, and have someone get upset because you're interrupting his (or her) call? (It's always my sister talking to one of her boyfriends.) Well, if you have that annoying situation, or would just like to know when the phone line is in use, this simple and inexpensive device will do the trick.

What the phone-line monitor does is to flash an LED whenever a telephone connected to that line is off its hook. Most of the parts needed to build it can most likely be found in your junk box, and construction is simple—the monitor can easily go on a piece of perforated board.

## TELEPHONE IN-USE MONITOR

*Do you embarrass easily? This phone line monitor will eliminate unintentional eavesdropping by indicating when a phone line's in use.*

### How it works

Let's look at what happens to the telephone line when someone takes a phone off the hook. Normally, with all phones hung up, a potential of approximately 48-volts DC exists across the two wires of the line. If any phone is picked up, it shunts across the line, and the voltage drops down to about six volts. That change is what is used to trip the monitor.

The circuit is shown in Fig 1. With the monitor connected across the phone line's red and green wires, and with all phones on-hook, a relatively strong potential is developed across resistor R2 (through R1 and R3—more about them later). That positive voltage keeps the base-emitter junction of transistor Q1 biased off. With Q1 off, there is no base current for transistor Q2; it is off, too. That keeps IC1 from flashing the LED because the return path back to the battery is not complete. This IC, an LM3909 is a low-power LED-flasher that needs only an electrolytic capacitor to flash an LED from

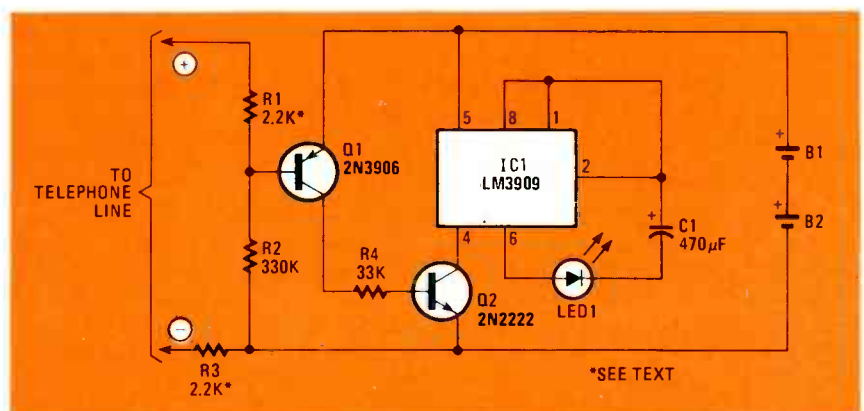

FIG. 1—BOTH POLARITY AND VOLTAGE at phone lines must be known in order for monitor to work. Use a voltmeter to determine them.



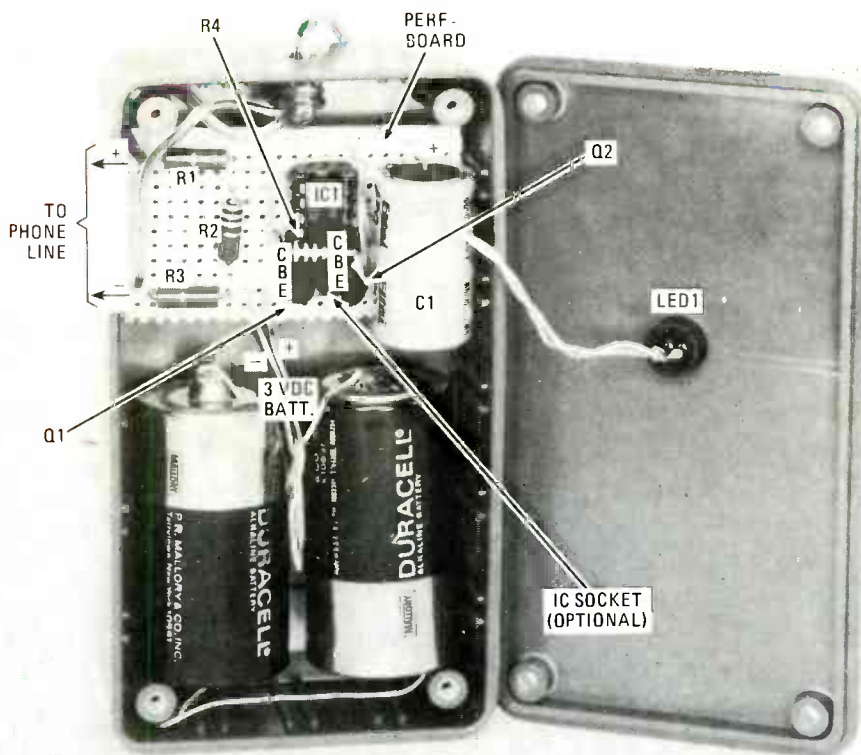

FIG. 2—COMPONENT PLACEMENT is not critical. Board and batteries are held in place by double-sided foam tape. If you wish, an IC socket can be used to hold the transistors as well as the IC. Keep the transistor leads as short as possible.

## PARTS LIST

### All resistors ½ watt, 10%

R1, R3—2.2 megohms\*  
 R2—330,000 ohms  
 R4—33,000 ohms

### Capacitors

C1—470  $\mu$ F, 10 volts, electrolytic

### Semiconductors

LED1—jumbo red LED  
 Q1—2N3906 or similar PNP-type  
 Q2—2N2222 or similar NPN-type  
 IC1—LM3909 LED flasher  
 B1, B2—1½-volt "C" cell

**Miscellaneous:** perforated construction board, case, 16-pin IC socket, double-sided foam tape, etc.

\*See text

## WARNING

Current FCC rules (Part 68) forbid direct connection of customer-owned equipment that is not FCC type-approved to telephone company lines. To use unapproved equipment, an approved protective coupler must be installed. Check with your local phone company for details.

1½ or 3 volts. I picked that arrangement for flashing the LED because the IC consumes so little power that, even if it were active continuously, the two "C" flashlight batteries would last well over a year.

When someone picks up a telephone, the phone-line voltage drops, and the potential across R2 practically disappears. That allows transistor Q1 to conduct, which, in turn, supplies base current to Q2, which also then conducts. When Q2 switches on, it provides the return path for IC1, and the LED starts flashing about three times a second. If all phones are hung up again, the voltage returns to 48 volts, shutting everything off.

Because the device connects directly to the phone line, I have taken precautions to insure that the line-monitor does not interfere with the normal operation of the phone system.

First, the unit is battery-operated, using two "C" cells. Under no circumstances should an external power supply be used. That insures that no hazardous voltages or earth grounds can be connected to the phone line.

Second, R1 and R3 provide 2.2 megohms of resistance on either side of the active circuit. (4.4 megohms total). While a single, large resistor could have been used in place of R1 and R3, I find it good practice to isolate as much as possible—again, as a safety precaution. Those resistors load down the line little, if at all.

## Construction

The circuit can be built on perforated construction board and mounted in any small box (Fig. 2). The "C" cells may be held by battery clips, or soldered directly to wires from the board. Everything is held in place by double-sided foam tape. The LED is mounted in the lid of the box. In Fig. 2, you will notice that a 16-pin IC socket is used to hold both the IC and the two transistors. While I found that to be the most convenient way to mount those components, the socket is optional.

Don't be surprised if the monitor starts blinking at you as soon as you apply power. Remember, it's a *high* voltage that turns it off. With nothing connected to it, the monitor thinks it's seeing a low voltage (in this case, *very* low), and turns on.

## Installation

The values given for resistors R1 and R3 (2.2 megohms) are for telephone systems using 48 volts, as measured with all the phones on the hook. In some parts of the country the voltage used may be different and, if you are uncertain about its value in your area, check it out with a voltmeter. Be careful when you make that measurement—that voltage can be dangerous!

If you obtain a reading that is considerably different from 48 volts, take that reading and divide it by 22. That will give you the correct value, in megohms, for R1 and R3.

The monitor will not work if it is hooked up backwards (R1 *must* go to the positive line), but it will not be harmed, either. Just reverse the leads to the phone, and you'll be in business.

With the monitor connected, before you pick up the phone, check to make sure the LED is not flashing. If it is, the line is in use. (It's probably my sister again.)

Also, check the November 1979 issue of **Radio-Electronics** for the Music-on-Hold adaptor. Build them in the same box for a super telephone add-on.

R-E

## HOW TO ALIGN VIDEO IF CIRCUITS

*Aligning video-IF strips isn't as difficult as you may think. Here are some helpful hints.*

**JACK DARR**  
SERVICE EDITOR

MANY TECHNICIANS CONSIDER VIDEO-IF alignment to be the most complex task they have to perform. But that's not true—the stages involved are not more complicated, it's just that there are more of them than in a radio! And, as the saying goes, "Complicated things are just a lot of simple ones strung together."

AM and FM radios have relatively narrow bandpasses—10 kHz in the case of AM; from 200 to 250 kHz in the case of FM. Generally, they use cascaded circuits (one circuit right after the other) operating on a single frequency. Video-IF stages have bandpasses as wide as 5 MHz—they're known as controlled-bandpass, wideband IF's—and in most respects are similar to the ones in radios, except that the tuned circuits are *not* all aligned on the same frequency.

The important thing in performing video IF-stage alignment is not gain, but rather the overall response of each stage. That is easy to adjust with a sweep generator, which we'll discuss shortly.

The video IF-strip consists of several cascaded amplifier stages, each with a tuned circuit at its input, output, or at both ends. Each stage has an ideal bell-shaped curve representing its response. The cartoon in Fig. 1 shows how the tuned circuits in an IF stage work. Each resonant circuit in the stage "pushes the curve up" at its resonant frequency. Using several circuits gives us the wide bandwidth we need. (The two figures sitting on the ends of the curve and holding it down will be discussed later.)

Figure 2-a shows the overall response of one IF-stage, with one of the tuned circuits peaked at the wrong frequency. The dip in the curve caused by this misalignment is obvious. In Fig. 2-b the

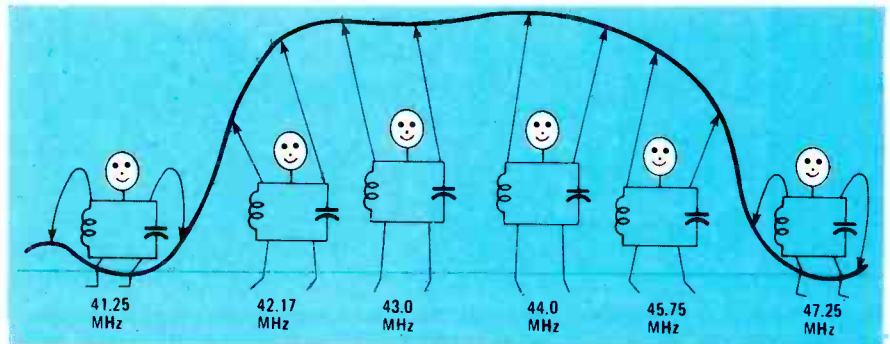

FIG. 1—EACH RESONANT CIRCUIT in the IF strip works to give the bandpass curve the correct shape.

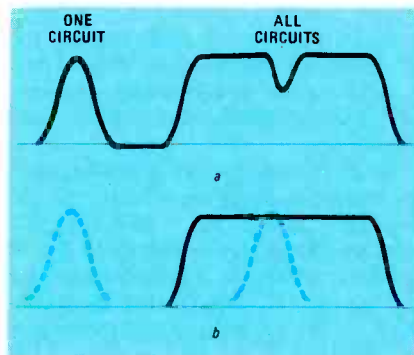

FIG. 2—AN OFF-FREQUENCY circuit will alter the shape of the curve. Retuning it will restore the curve to normal.

misaligned circuit has been retuned to the correct frequency and the overall response of the stage is now what was intended. That's how *all* the resonant circuits in an IF stage work—they alter both the height *and* the shape of the curve at the points they affect. When an IF stage is properly aligned, the resulting curve looks pretty much like the one in Fig. 2-b.

### Traps

Shaping the response of an IF stage means not only boosting certain frequencies, but also attenuating or eliminating some of them. That's what the two figures sitting on the ends of the curve in Fig. 1 are doing.

Figure 3 shows the two types of resonant circuits used in curve shaping. The parallel-resonant circuit at the right of Fig. 3-a boosts the response at the resonant frequency, as shown in Fig. 3-b. The series-resonant circuit at the left of Fig. 3-a does the opposite—it removes signals at its resonant frequency. (It has a very low impedance at resonance.)

Series-resonant circuits are used to reduce the strength of, or get rid of entirely, unwanted signals at specific frequencies. When they perform that function, they are called *traps*.

Traps are never used within the bandpass range; they are used to shape the slopes of the ends of the curve and to insure that signals from other channels do not get into the IF strip. The major



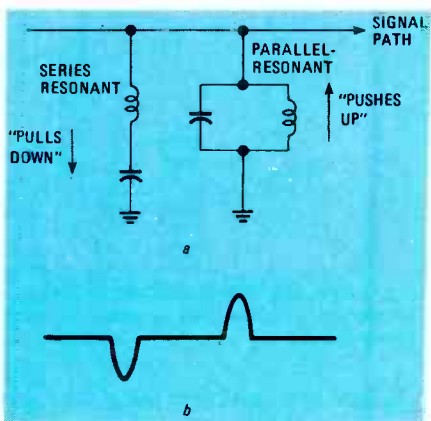
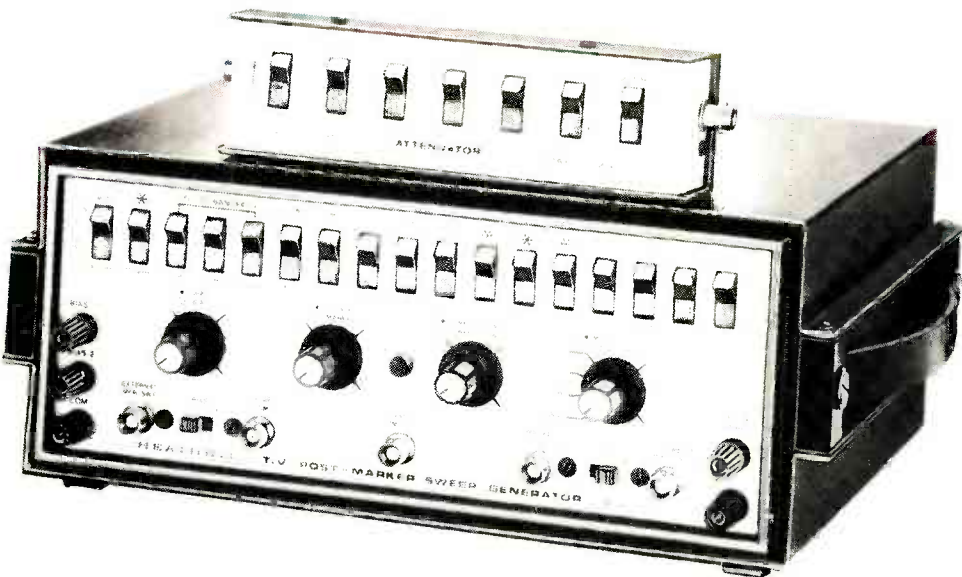

FIG. 3—A SERIES-RESONANT circuit has low impedance and acts as a trap. A parallel-resonant one reinforces the signal.

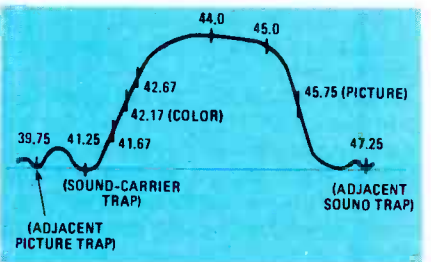

FIG. 4—A REPRESENTATIVE IF CURVE, showing all the key marker-frequencies.

difference between tuning traps and the other resonant circuits in the IF strip is that the traps are always adjusted to give *minimum* response. Because they determine the shape of the endpoints of the response curve, tuning the traps is always the first part of any TV-IF alignment procedure.

**Sweep alignment**

To align a TV-IF circuit properly, it is

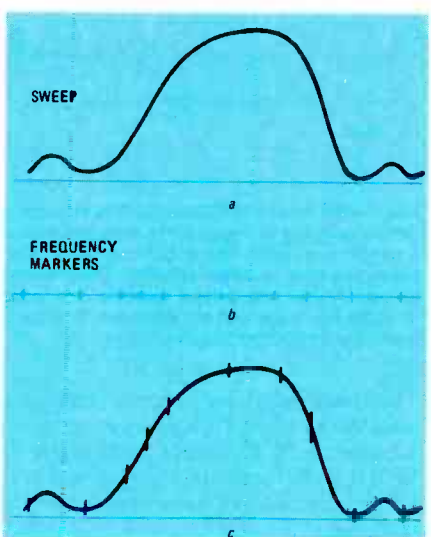

FIG. 5—SWEEP AND MARKER SIGNALS are mixed in the marker adder to create a marked-sweep curve to be fed to an oscilloscope.

important to be able to see the response of the entire curve. That way, the effect of any adjustment on the overall shape of the curve is instantly obvious. If you try using single-signal methods, and tuning each circuit for maximum, you can wind up with some *very* interesting results! Therefore, sweep-alignment equipment, which allows you to view the entire curve at once, is required.

The original sweep-frequency generators were called "wobblers" because they wobbled (swept) the signal back and forth; the response-curve of the IF strip was displayed on an oscilloscope. What they didn't do was to locate, or mark, the critical frequencies on that curve.

There are *nine* different frequencies (see Fig. 4) that are critical to IF-strip

alignment, and it is important that adjustments be made exactly at those frequencies. To locate them, a marker generator is used.

**Marker generators**

In the early days, markers were placed on the curve by a tunable RF signal-generator. The disadvantage of that was that only one marker could be seen at a time. The signal generator had to be retuned each time a new frequency was checked. (There was a way around that. The critical points could be marked, one by one, on the screen of the oscilloscope with a grease pencil. That system worked fairly well as long as the sweep generator was not retuned.)

Another disadvantage was that when the marker frequencies were fed through the video-IF-strip together with the sweep signal, the curve could be badly distorted if the level of the marker signal was too high. The marker generator also had to be *very* accurately calibrated.

**Current sweep-generators**

The current generation of sweep generators makes alignment a lot simpler. They have two very useful features. First, they have separate, crystal-controlled, markers for each key frequency. Any, or all, of the markers can be used at any time.

The other feature is a circuit called a post-injection marker-adder (or just "marker adder," for short). The marker adder is actually separate from the sweep generator and only the sweep signal goes through the circuits being aligned. A small portion of that signal is fed to the marker adder, and the markers are added electronically at that point. The marker-adder's output is then fed to the scope. Figure 5 will give you an idea of how that works.

The crystal-controlled markers are extremely accurate because each one is generated by a separate circuit. Furthermore the markers cannot cause curve distortion in the IF stage because they never pass through it.

With today's equipment, and a little knowledge of what's going on, video-IF-strip alignment turns out to be a lot less complicated than you may have thought it to be.

R-E

# DESIGNING CIRCUITS WITH OP-AMPS

Perhaps the most universal integrated circuit is the operational amplifier. Here's how to design your own op-amp circuits

JOSEPH J. CARR

THE INTEGRATED CIRCUIT WAS INVENTED in the early 60's, and has taken off like a rocket ever since. Devices have grown steadily in complexity. The early  $\mu$ A703, for example, contained only a few transistors and a couple of resistors, and was used extensively as an FM IF amplifier...and not much else. The  $\mu$ A703 was a real hit, but that device is now considered "low technology" and is no longer used.

We now have MSI and LSI (Medium Scale Integrated and Large Scale Integrated) devices that may contain hundreds or thousands of transistors and other components on a single chip. They are even developing VLSI (Very Large Scale Integrated) circuits.

The biggest portion of the IC market are the digital IC's, but don't count analog devices down and out quite yet; they are alive and kicking in many areas of technology and can out-perform devices made only a few years ago.

There are several technologies used for creating transistors and other components on a slab of semiconductor material. This slab is referred to as a substrate. There may be several layers of material in the integrated circuit of which the substrate is the bottom-most.

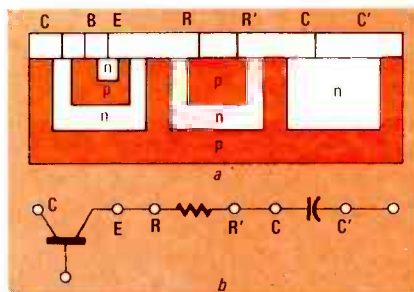

FIG. 1—AN INTEGRATED CIRCUIT is formed by diffusing layers of p-type and n-type material on a p-type substrate. The uppermost layer is an insulating layer of silicon dioxide. Connections to the n-type and p-type material are made through this layer and are indicated by vertical lines. The equivalent circuit is shown in b.

The usual substrate is approximately 6 mils thick, with a typical cross-sectional area being  $50 \times 50$  mils, with some up to  $160 \times 160$  mils. In Fig. 1-a, the substrate is shown as P-type semiconductor material.

The second layer is made of N-type material, and is grown as an extension of the P-type substrate crystal. In operation, that PN junction must be maintained at a reverse bias potential or the IC will be destroyed. That region is approximately 5 to 30 micrometers thick. The next region is P-type material, while the uppermost is again N-type material. Lastly, a layer of silicon dioxide is formed over the top of the silicon slab. The silicon dioxide is an insulating material and connections to the various regions are made through that layer, indicated in Fig. 1-a as vertical lines.

The equivalent circuit is shown in Fig. 1-b. In this case, a transistor is in series with a resistor and capacitor. The transistor is formed from elements of the second, third, and fourth layers of the substrate. Since the transistor is an NPN device, the collector and emitter terminals are connected to N-type (second and fourth) layers of the substrate. The series resistor is formed by the re-

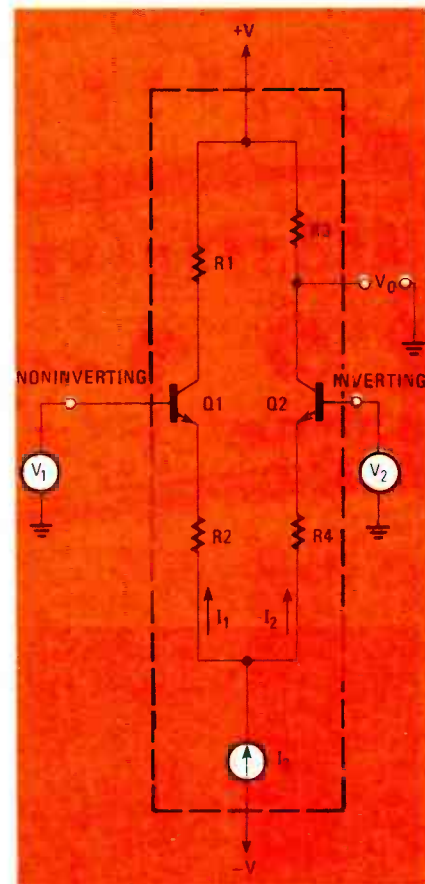

FIG. 2—OP-AMP INPUT CIRCUIT is actually a differential amplifier that requires a bipolar power supply.

sistance of a section of the N-type second layer. It is connected to the emitter section by depositing a metallized strip over the silicon dioxide.

The capacitor is formed by sandwiching the silicon dioxide between an N-type layer and a metalization layer. The dielectric of the capacitor is the silicon dioxide layer.

Integrated circuits do not often contain capacitors because of the size and cost. In general, only small-value (picofarad-range) capacitors can be integrated onto the substrate. Hybrid circuits, which use a combination of integrated-circuit technologies and discrete component techniques, often use small tiny capacitors called chip capacitors. Those capacitors are mounted on a ceramic substrate along with several unpackaged IC chips.

## The operational amplifier

The operational amplifier is a linear integrated circuit that has an immense variety of applications. The op-amp can be used in relatively complex circuits, yet the design rules are easy to master. The typical operational amplifier has two inputs, called inverting and non-inverting inputs. That is not a require-



ment in the definition of the operational amplifier, but it is true that almost all op-amps have two inputs: Only a few devices on the fringes of the linear IC market are op-amp-like, yet have but one input (the LM302 device, for example).

The operational amplifier was designed originally to perform mathematical operations in analog computers. That means that it had to operate on a variety of input-data values, and then be able to produce an output of either polarity depending upon the required answer.

As a result, operational amplifiers require a dual-polarity power supply. The positive (+V) power supply is positive with respect to ground, while the negative (-V) power supply is negative with respect to ground.

Figure 2 shows a typical input circuit for an operational amplifier. The two transistors (Q1 and Q2) of the differential pair are connected so that their emitters are fed from a single constant-current source ( $I_3$ ). The constant-current source will produce a constant current, despite changes in the load resistance. Most IC constant-current sources are bipolar transistors, biased in a particular manner. In Fig. 2, the two emitter currents ( $I_1$  and  $I_2$ ) are derived from the constant source  $I_3$ . We know from Kirchoff's current law that the following relationship holds true:

$$I_1 + I_2 - I_3 = 0 \quad (1)$$

$$\text{or} \quad (2)$$

$$I_1 + I_2 = I_3 \quad (2)$$

For the purposes of this discussion, we are going to assume that the emitter and collector currents of the two transistors are equal (i.e.,  $I_{C1} = I_{C2}$  and  $I_{E1} = I_{E2}$ ). In actual fact they are different by two to five percent, but that does not present a problem.

Let's assume that a voltage ( $V_1$ ) is applied to the base of transistor Q1. What happens? How does the circuit respond? When  $V_1$  is made positive, the collector and emitter current of Q1 ( $I_1$ ) will increase. That increase in current  $I_1$  must (by equations 1 and 2) cause a decrease in current  $I_2$ . Current  $I_2$  is the emitter current in the transistor Q2. Since  $I_2$  decreases, the voltage drop across resistor R3 also decreases (i.e.,  $I_2 \times R3$  decreases). The output voltage  $V_0$  is the difference between the collector potential and the voltage drop across resistor R3, so a reduction in  $I_2$  causes an increase in  $V_0$ . Here we have a positive increase in  $V_1$  causing an increase in output-potential  $V_0$ . The base of transistor Q1 is, therefore, the non-inverting input.

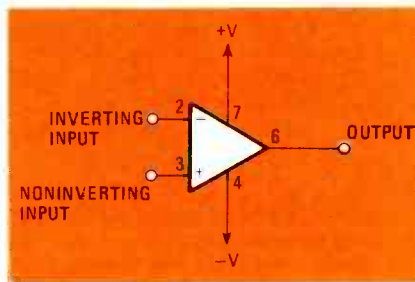

FIG. 3—SCHEMATIC SYMBOL and industry standard pinout of an operational amplifier.

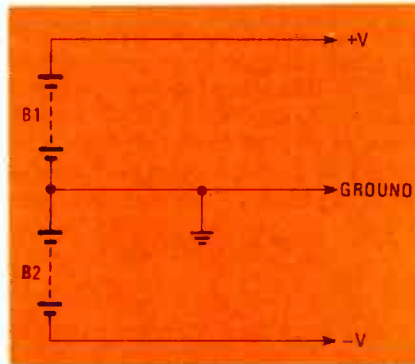

FIG. 4—BIPOLAR POWER SUPPLY can be built using batteries as shown.

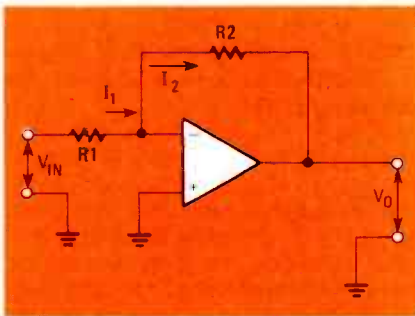

FIG. 5—BASIC INVERTING AMPLIFIER. The gain is determined by the ratio of R2 and R1. Point A is called a virtual ground.

TABLE 1

1. Infinite input impedance
2. Infinite open-loop (no feedback) gain
3. Zero output impedance
4. Infinite bandwidth
5. Zero noise contribution
6. Both input voltages track each other.

Now let's examine what happens when an input voltage ( $V_2$ ) is applied to the base of transistor Q2. When voltage  $V_2$  is positive, current  $I_2$  increases. When current  $I_2$  increases, the voltage drop across resistor R3 increases. The increased voltage drop across R3 causes a decrease in the output voltage. Therefore, the base of transistor Q2 is the

inverting input: a positive input voltage produces a decrease in the output voltage.

Output-voltage  $V_0$  is normally zero when both input voltages ( $V_1$  and  $V_2$ ) are equal.

### Operational amplifier symbol

The operational amplifier symbol used in circuit diagrams is shown in Fig. 3. It consists of a triangle with the output at one apex, usually oriented horizontally. Some texts follow the IEEE convention of using the straight-back symbol (as shown here) for linear amplifier IC devices, and a similar version with a curve back for the operational amplifier. In *Radio-Electronics*, however, we use the more common convention—as shown in Fig. 3.

The two inputs of the operational amplifier are labeled (-) for the inverting input and (+) for the noninverting input. The +V and -V power-supply terminals may or may not be shown in some schematics. Many people delete the power-supply terminals on their drawings for the sake of simplicity. Make no mistake about it, however: The power-supply terminals are still to be connected! The pin-out numbers shown in the illustration were originally for the 741 device only, but that particular arrangement is now considered the "industry standard." Most commercial integrated-circuit op-amps use that pinout.

The +V and -V power-supply terminals are not +V and ground, but two separate power supplies of opposite polarity with respect to ground. The +V power supply is positive with respect to ground, while the -V power supply is negative with respect to ground. A battery version of the typical operational amplifier power supply is shown in Fig. 4. Note that this power supply has a ground connection, but there is no ground terminal on the operational amplifier symbol! The input and output potentials are measured with respect to ground, so the ground must come from the power supply.

### Operational amplifier properties

A simple linear amplifier using an operational amplifier is shown in Fig. 5. We can analyze the operation of this circuit by using Kirchoff's current law and the basic properties of the operational amplifier. For purposes of discussion, we will consider the properties of an *ideal* operation amplifier. Table 1 lists the six basic properties of the ideal operational amplifier:

An infinite input impedance means that the input neither sinks nor sources current. The input impedance of any amplifier is given by  $V_{in}/I_{in}$ . If the input

will neither accept (sink) nor generate (source) current, then  $I_{in}$  is zero and the input impedance is infinite. In actual operational amplifiers, which are not ideal, the input impedance is not quite infinite; but it's extremely high. Some low-cost cheapie operational amplifiers are only able to offer input impedances of 100,000 ohms, but most devices can boast 1 megohm or more. A few devices, such as the RCA BiMOS devices (which have MOSFET input transistors) have input impedances of 1.5 teraohms ( $1.5 \times 10^{12}$  ohms)! That reflects input currents of picoamperes or nanoamperes.

Infinite open-loop gain means that the amplifier gain is infinite when there is no negative feedback present. In real operational amplifiers, the open-loop gain will be 20,000 for cheapies, and over 1,000,000 for some premium devices.

An ideal operational amplifier is said to have a zero output impedance. In real operational amplifiers, however, we find output impedances of less than 200 ohms, with most under 75 ohms.

Infinite bandwidth means that the device will amplify all signals applied to the input, regardless of frequency. But, that is not the case in real operational amplifiers. Many devices operate into the HF region and some devices operate into the low VHF region. Most common operational amplifiers, however, are severely limited in frequency response. The popular 741 device, for example, has a frequency response of only a few kilohertz.

Zero noise-contribution means that the op-amp adds no noise to the signal it amplifies. Unfortunately, most operational amplifiers fall far short of that ideal: Some premium (high cost) devices offer very good noise performance, but most common operational amplifiers do not perform well as low noise-amplifiers.

Both input voltages track each other. What does that mean? It means that applying a voltage to one input requires us to treat the other input mathematically as if it, too, were connected to the same voltage. That is not merely some theoretical device used in mathematical formulas; it is real. If you apply 4 volts to the noninverting input, then you can measure 4 volts at the inverting input also! That phenomenon is one of the most important of the ideal properties!

### Inverting-follower circuits

Figure 5 shows the circuit for the inverting-follower configuration. An inverting follower uses the inverting input of the operational amplifier. Note that the noninverting input is grounded in this circuit. That is the same as saying that the noninverting input is at zero potential. A result of ideal property No. 6 listed in Table 1 is that the inverting input must now be treated as if it were also at zero potential. The inverting input is essentially grounded, even though

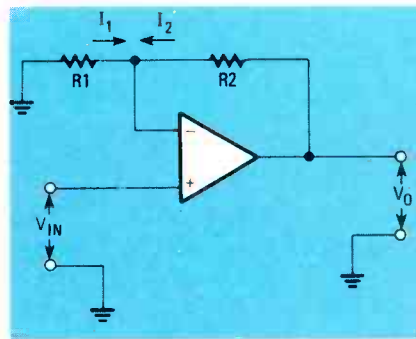

FIG. 6—BASIC NON-INVERTING amplifier. The input signal is fed to the non-inverting input terminal.

not physically connected to ground. That confusing state of affairs is not made too much clearer by the name usually given to the phenomenon: "virtual ground." The virtual ground is *treated* as a ground even though it is not actually grounded through a piece of wire.

What do we know about the circuit in Fig. 5? We know that the currents are as follows:

$$I_1 = V_{in}/R1 \quad (3)$$

and,

$$I_2 = V_o/R2 \quad (4)$$

we also know from Kirchoff's current law that:

$$I_1 = -I_2 \quad (5)$$

So, by substituting equations 3 and 4 into equation 5, we obtain:

$$V_{in}/R1 = -V_o/R2 \quad (6)$$

We can solve equation 6 for  $V_o$ , thereby obtaining the transfer equation for the inverting follower:

$$V_o = -V_{in} \times R2/R1 \quad (7)$$

The gain of any amplifier is the quotient  $V_o/V_{in}$ , which in this case is  $R2/R1$ . That relationship means that we can set the gain of the inverting-follower operational amplifier circuit by setting the ratio of two resistors! The absolute values of the resistors are not important, only their ratio. For example, if the feedback resistor ( $R2$ ) is 100,000 ohms, and the input resistor is 1000 ohms, then the gain  $R2/R1$  is 100,000/1,000, or 100.

There is a problem associated with the inverting follower. The input impedance is low, being limited to the value of input-resistor  $R1$ . That is because one end of  $R1$  is grounded as a result of the "virtual" ground. The apparent solution to the problem is to use an input resistor that has a sufficiently high value. But that is not always possible, due to gain problems (remember, the open-loop gain is not infinite), and because certain problems with real operational amplifiers are made worse by using high-value resistors in the feedback and input circuits. Unless phase inversion is needed in the circuit, there may be good reason to opt for the non-inverting follower.

### Non-inverting follower with gain

Figure 6 shows the circuit for the non-

inverting-follower configuration. In this circuit, the signal is applied directly to the non-inverting input of the operational amplifier. The feedback network is the same as in the inverting follower, except that  $R1$  is now grounded.

Recall ideal property No. 6 listed in Table 1: Applying voltage  $V_{in}$  to the noninverting input has the effect of placing the other (inverting) input at the same potential. Since there is no phase inversion in the circuit, the output signal has the same polarity as the input signal, so:

$$I_1 = I_2$$

By the same sort of reasoning as in the previous case:

$$I_1 = V_{in}/R1 \quad (9)$$

and:

$$I_2 = (V_o - V_{in})/R2 \quad (10)$$

We can obtain the transfer equation for the circuit by substituting equations 9 and 10 into equation 8, which yields:

$$V_{in}/R1 = (V_o - V_{in})/R2 \quad (11)$$

Algebraically rearranging equation 11 yields:

$$V_{in} \times [(R2/R1) + 1] = V_o \quad (12)$$

Equation 12 is the transfer equation for the non-inverting follower with gain circuit shown in Fig. 6. Note that the circuit will always have a gain of at least 1, since the gain factor is  $(R2/R1) + 1$ .

The input impedance of the non-inverting-follower circuit is very high, being limited by the input impedance of the operational amplifier. Recall that typical operational amplifiers have an input impedance greater than 1 megohm, with some models offering impedances as high as  $10^{12}$  ohms. The non-inverting follower, therefore, is best suited for use with high-impedance circuits. In the case of some oscillator and timer circuits, it also relieves us of the problem of considering the effects of the input impedance of the amplifier on R-C time constants.

### Unity gain non-inverting followers

In the non-inverting-follower circuit shown in Fig. 6, the feedback was only a fraction of the output signal and was set by a voltage divider consisting of  $R1$  and  $R2$ . Let's investigate what happens when we feed back all of the output signal. We can accomplish that by connecting the output of the operational amplifier to the inverting input directly, as

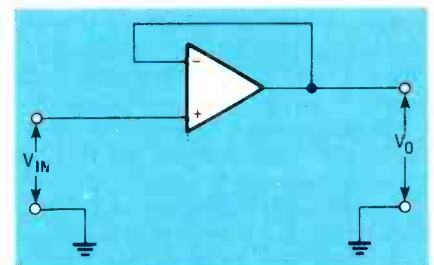

FIG. 7—UNITY-GAIN AMPLIFIER has high input impedance and low output impedance. This circuit is used as a buffer.



shown in Fig. 7.

Substituting  $R_f = 0$  in equation 12 yields:

$$V_o = V_{in} \quad (13)$$

Thus, the gain of the circuit shown in Fig. 7 is equal to 1. To understand why, recall ideal property No. 6. We know that if  $V_{in}$  is applied to the non-inverting input, then that same potential must also exist on the inverting input. But the inverting input is also connected to the output, so  $V_{in}$  must also exist on the output of the operational amplifier!

OK, but what's the use of a unity-gain amplifier? Aren't amplifiers supposed to amplify? The voltage amplification is nearly unity in that circuit (0.9999999), yet the output impedance is very low. Since the input impedance of the operational amplifier is very high, then it becomes obvious that the unity-gain follower can be used for impedance transformation without loss of amplitude between a high-impedance source and a low-impedance load. Also, the unity-gain non-inverting follower can be used as a buffer stage to provide some isolation without either a change of amplitude, or phase inversion.

### Differential amplifiers

The two input terminals of an operational amplifier are complementary; that is, they produce an equal but opposite effect on the output signal. If a voltage is applied to the non-inverting input, the output will have the same polarity as the input signal. But, if that same voltage is applied to the inverting input, then the output will have the opposite polarity. The gain of the amplifier in each case is the same, but the output polarity is opposite. The inputs of the operational amplifier are, therefore, differential. The actual input voltage seen by the op-amp is the difference between the potentials applied to the inverting and non-inverting inputs. We can, therefore, use the operational amplifier to make a differential amplifier.

An example of a simple operational differential amplifier (diff-amp) is shown in Fig. 8. This circuit is the simplest form of a diff-amp.

The gain of this circuit is:

$$\text{Gain} = R_3/R_1 \quad (14)$$

Provided that

$$R_1 = R_2 \quad (15)$$

$$R_3 = R_4 \quad (16)$$

The ideal differential amplifier will not respond to a common-mode voltage (that is, a signal voltage applied equally to both inputs simultaneously). The real differential amplifier, however, will respond somewhat to a common-mode voltage and produce a small output voltage, called the common-mode error voltage. The ratio of the common-mode voltage (a voltage applied equally to both input terminals) to the common-mode error voltage (resulting error voltage that appears at the output of the

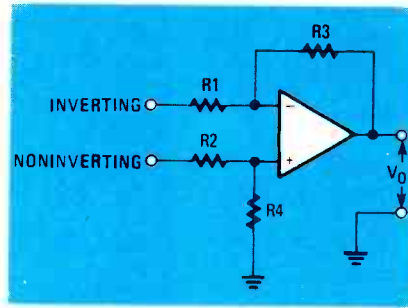

FIG. 8—DIFFERENTIAL AMPLIFIER circuit amplifies the difference between the two input signals.

op-amp) is called the common-mode rejection ratio (CMRR) and is expressed in dB. Some operational amplifiers have a CMRR of 120 dB (1,000,000:1), while even garbage-grade blister-pack op-amps have CMRR ratings in the range of 60 dB!

The differential amplifier is used extensively in circuits where noise pick-up is a factor. The human electrocardiogram signal, for example, is very weak (1 mV), yet interference from 60-Hz power lines can be several volts on an 8-foot cable leading to the patient being monitored. The result is that the signal is completely swamped by 60-Hz interference that is 1000 times greater! However, if we treat the electrocardiogram signal from the surface of a patient's body as a differential signal, we find that the 60-Hz signal will be seen by the differential amplifier as a common-mode signal, whereas the electrocardiogram signal is seen as a differential signal. The gain of the amplifier may be 1000 for the differential signal and the amplifier will significantly attenuate the 60-Hz components. The result is an electrocardiogram trace that is essentially free of 60-Hz interference.

### Operational amplifier problems

The properties of the ideal operational amplifier are never realized in practical devices. The ideal properties are closely approximated in some premium devices, but there is always some discrepancy. Those problems fall into several categories. We have already discussed the matter of frequency response and common-mode rejection ratios. We also find that there are several DC-offset problems that cause the output voltage to be non-zero at times when it should be zero.

There are several sources of offset voltage. One is the bias currents of the transistors used in the input circuit. Remember that the ideal operational amplifier has an infinite input impedance, which means that the input terminals will not sink any current. But real operational amplifiers are built from real transistors that require bias current. The bias current for some premium grade devices may be nanoamperes, or

even picoamperes, but in some cheapies the bias current may be a fraction of a milliamperes! The error voltage generated at the output of the operational amplifier by this bias current is equal to:

$$I_{\text{bias}} \times R_f$$

where  $R_f$  is the resistance of the feedback resistor. Also, the bias current will cause a voltage drop to appear at the input terminal that is equal to the product of the bias current and the parallel combination of the feedback and input resistances [ $R_f \times R_2 / (R_f + R_2)$ ].

One method for reducing the error voltage caused by the input-bias current is shown in Fig. 9. That circuit works because the operational amplifier input circuit is symmetrical, meaning that identical currents will flow in both input terminals. If the value of resistor  $R_3$  is equal to the parallel combination of  $R_1$  and  $R_2$ , then both input terminals see an equal resistance to ground. The bias current at each input terminal will then generate an equal error voltage at each input terminal and the common-mode rejection ratio will cancel the effect at the output terminal.

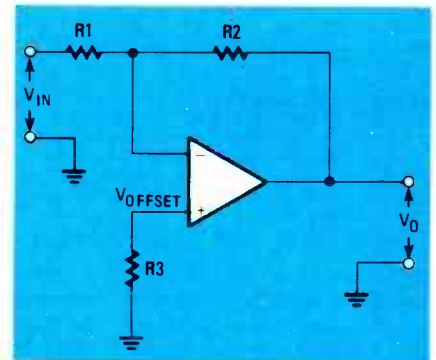

FIG. 9—INPUT BIAS CURRENT causes an error voltage to appear at the output of the op-amp. The voltage drop across resistor  $R_3$  (caused by the input bias current) cancels the output error voltage.

Unfortunately, input-bias currents are not the only source of offset voltages on the output line. There are actually several causes, some of them inside of the operational amplifier and others from outside sources (for example, the power supply). The circuits shown in Figs. 10 and 11 will allow us to cancel any type of offset voltage, including the offset voltage caused by the input-bias current.

The circuit shown in Fig. 10 is used with operational amplifiers that have offset compensation terminals. Those terminals allow us to balance the emitter currents of the input amplifier transistors to allow for offset variations.

Another, more universal, method for cancelling the offset voltage is shown in Fig. 11. In this circuit, which can be used whether or not the operational amplifier has offset-compensation terminals, we add a current to the input sum-

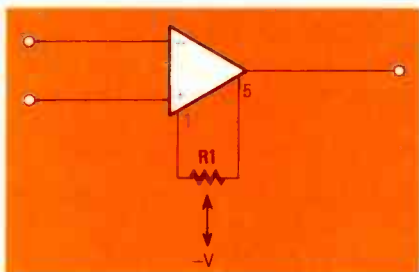

FIG. 10—OFFSET COMPENSATION terminals are provided on some op-amps. Potentiometer R1 is adjusted to eliminate offset errors that appear at the output.

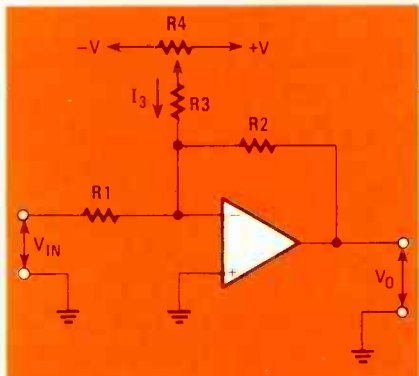

FIG. 11—SIMPLE CIRCUIT for eliminating offset errors with op-amps that do not provide offset compensation terminals.

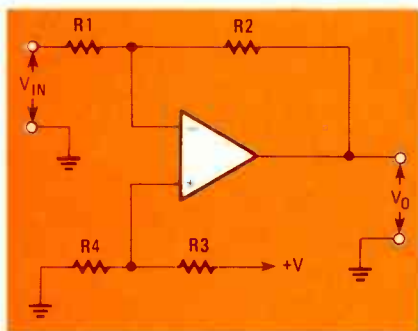

FIG. 12—SINGLE-POLARITY POWER SUPPLY can be used with an op-amp by biasing the non-inverting input at half the power-supply voltage. In this case, resistors R3 and R4 are equal.

mation junction of the inverting follower (or the non-inverting follower, if desired) that exactly cancels the output offset voltage. Resistors R1 and R2 are the normal input and feedback resistors used in the amplifier, while R3 and R4 are part of the offset cancellation circuit. Potentiometer R4 is adjusted so that current  $I_3$  exactly cancels the normal offset voltage and no more (otherwise, the offset-cancellation voltage becomes an offset in its own right.)

The operational amplifier is designed to operate from bipolar power supplies.

During normal operation, the  $-V$  and  $+V$  power supply contributions to the output voltage depend upon the polarity of the input signal. When the input signal is zero, the respective contributions are zero. But what happens when the operational amplifier must be operated from a single-polarity power supply? In that case we must bias one input (usually the non-inverting input) to some potential between zero and the power-supply voltage. The output voltage will be equal to that potential when the input signal is zero, and will swing about the bias potential when the input signal is non-zero. In most cases (see Fig. 12) the non-inverting input is biased at one-half  $+V$  by making resistors R2 and R3 equal to each other. R-E



"NO! NO! NO! That's not what I meant by trouble-shooting!"

## SERVICE QUESTIONS

### HALF RED-BLUE, HALF GREEN

I've got a Philco C7261TMA-1 whose screen is red-blue on the left and green on the right. I changed the picture tube (the old one was bad, anyhow), but that didn't help. Where do I go from here?—L.B., Salt Lake City, UT

I've seen almost the same thing—also in a Philco. The left half was gold and the other blue. Try scoping all the B+ lines around the bandpass-amplifier stages—any point that has a bypass capacitor on it. You should see no signals at all. If you do, one of the bypasses isn't working and you will get feedback that upsets the color.

(Feedback: Thanks for the idea. The scope showed all kinds of signals on the B+ lines. I replaced both of the big filter capacitors and that cured the color problem and some others in the horizontal and vertical circuits.)

### TOP-STRETCH CURE

My good buddy Bill Stiles, of Hollsboro, MO, has sent me another of his jewels. He had asked about top-stretch in an Admiral 12H10 and I suggested checking the .039  $\mu$ F capacitors in the vertical-output grid circuit.

He did, and although they checked out OK, he decided to replace C74 and C76 anyway. That cured the stretch!

(And showed up another problem. The vertical-centering control wouldn't work properly. A new one set everything right.)

If you run into this sort of problem in this or similar chassis, try new capacitors, even if the old ones look OK.

### HOT RESISTOR

This RCA CTC-31A burns up R163 (the plate load-resistor from the horizontal-oscillator plate to B+) and then loses drive. A new resistor brings back the HV for about two minutes and then the resistor burns up again. The tubes, etc. all seem to check out. What's going on here?—B.C., Kent, OH

This sounds familiar—we ran into almost the same thing in a CTC-22 some time ago. The horizontal-oscillator plate in this set is fed by a "parallel path." At turn-on, voltage is fed through R163 from B+; after the set warms up, the oscillator is fed through a pair of 220K resistors in series from boost and R163 doesn't have to carry so much current.

Check to see whether one or both of the 220K units are bad and replace what's necessary. If they were bad, R163 would have had to carry the full load, and it's only a 1/2-watt type. Replace it with a 1-watt just for luck.

### ODD PICTURE

I've got a TS941 Quasar. I get a couple of black patches near the top of the raster—they come and go, as well as writhe. Even-

tually the picture goes dark and narrow and compresses in the center, making a bright vertical streak. This is weird!—J.G., Oak Park, IL

It certainly is. I've heard of something like this before. The cause of the problem is usually a big 500  $\mu$ F filter capacitor, Q508, located under the power-supply chassis. The negative connection breaks loose or becomes intermittent. Make sure the ground lead is good, and well soldered.

### LOSS OF VIDEO

I've got good sound but no video in this RCA KCS-169B. The base of the video amplifier (Q3) is OK with no signal (+2 volts), but goes to -5.5 volts when signal is applied, cutting off that stage. Replacing the transistor did no good. The video signal to the base is too high (5.5 volts); it should be 2 volts. Any suggestions?—W.M., Springville, NY

Yes! You should recheck the Q3's base circuit; that is L8, R22, R24, and R3 to ground. Apparently there is some positive voltage being fed into the control circuit from the detector-return circuit and R21 to ground. I'd say that this should go more positive with increasing signal strength since it comes off the detector cathode. That should prevent the base of Q3 from being driven into cutoff. Check the video-bias control to see if it does anything; it should. I'd also check the little choke for an open circuit, etc. Also check for bad solder joints. R-E



# UHF-TV PREAMPLIFIER

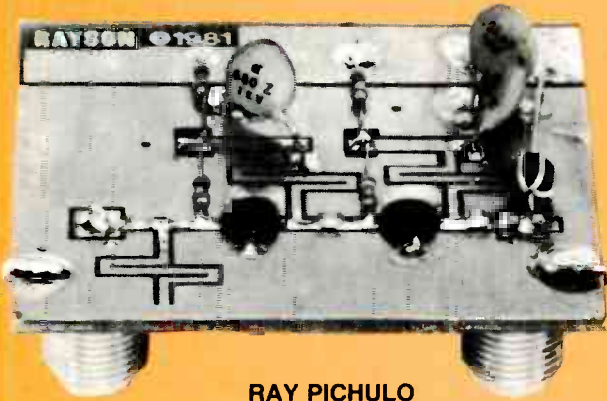

RAY PICHULO

*This inexpensive antenna-mounted UHF-TV preamplifier can add more than 25 dB of gain to your system and pull in signals you never knew were there. You'll also learn how to optimize your UHF reception through other means.*

UNTIL RECENTLY, NOBODY SEEMED TO care too much about good UHF-TV reception, and most people were content to take whatever quality they could get. The situation became serious enough to warrant an investigation by a committee made up of FCC and industry representatives. They published their findings late in 1980, and their major conclusion was that the most direct way to improve UHF-TV reception was through effective receiving-antenna systems.

### Adding more gain

Antenna selection and feedline considerations were discussed in the July, 1981 issue of *Radio-Electronics*, and we'll take a closer look at them in Part 2 of this article, but what happens if the proper antenna and feedline are used and we still don't get the results we want. What then? The next step is to consider a mast-mounted preamplifier.

First, let's clear up a common misconception about preamplifiers. Many people believe that a preamplifier aids reception by boosting the signal level; that's only partly true. What is more

important is that a preamplifier reduces the system noise-figure, which is the overall limiting factor to any receiving system's sensitivity.

There are two sources of noise—external and internal. External noise may be either atmospheric noise or man-made noise from electrical discharges. At UHF frequencies, external noise is very low, so the major noise source is internal—circuit noise. There is a great deal of room for improvement here, since a typical UHF tuner has a noise-figure of approximately 12 dB. The amount of noise introduced by the front end of a receiver plays a major part in establishing the overall receiver noise-figure, because each successive stage amplifies the noise introduced in the preceding stages.

The effect of gain on overall-system noise-figure can be calculated using the following formula:

$$N_T = N_1 + \frac{N_2 - 1}{G_1} + \frac{N_3 - 1}{G_1 G_2}$$

Where:

$N_T$  = overall-system noise-factor

$N_1$  = noise-factor of the first stage

$N_2$  = noise-factor of the second stage

$N_3$  = noise-factor of the third stage

$G_1$  = power gain of the first stage

$G_2$  = power gain of the second stage

Note that all numbers must be in terms of power gain, because the use of dB will result in large errors—especially when low noise-figures are involved. Noise-factor can be converted to noise-figure using the following formula:

$$Nf (g) = 10 \log_{10} N$$

Where:

$g$  = gain in dB

$N$  = noise factor

$Nf$  = noise figure

Noise-figure can be converted to noise-factor by using the formula:

$$N = \frac{\log^{-1} Nf (g)}{10}$$

In the same way, power gain ( $G$ ) can be calculated from gain ( $g$ ) as follows:

$$G = \frac{\log^{-1} (g)}{10}$$

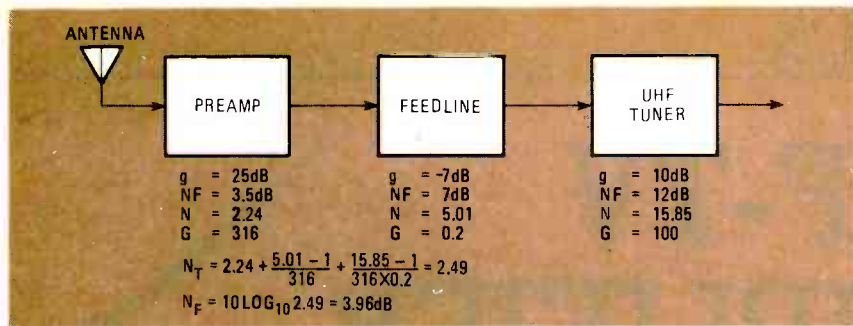

FIG. 1—PLACING A PREAMPLIFIER with a gain of 25 dB and a noise-figure of 3.5 dB at the antenna-end of a UHF receiving-system gives a total noise-figure of 3.96 dB.

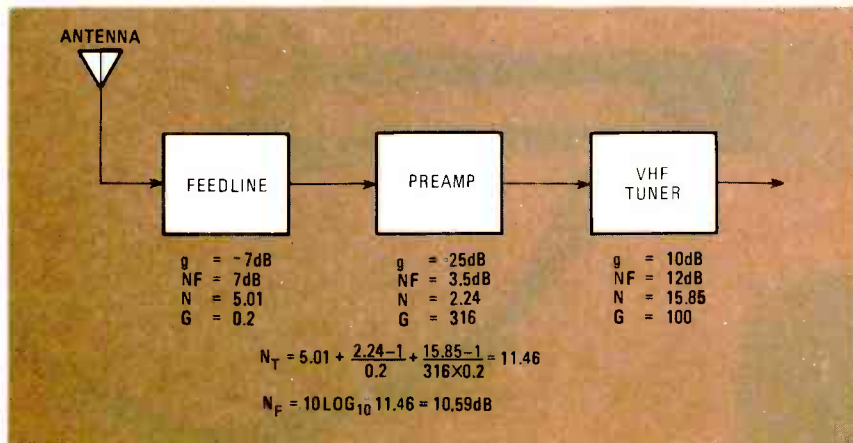

FIG. 2—PLACING THE SAME PREAMP at the receiver-end of the system increases the noise-figure to 10.59 dB.

Now that we've introduced those relationships, let's look at a model of a typical receiving system. Figure 1 shows a block diagram in which we consider the feedline to be the first stage. (That is valid in our calculations, as you will see.) Gain can be negative as well as positive; in the case of the feedline, we consider the insertion loss to be negative gain. The noise-figure of the feedline is essentially equal to the loss.

Let's see what happens when we add a preamplifier with a gain of 25 dB and a noise-figure of 3.5 dB, first at the antenna as shown in Fig. 1, then with the amplifier at the input of the receiver as in Fig. 2.

With the preamp at the antenna, the total calculated noise-figure for the three elements shown in Fig. 1 is 3.96 dB. By putting the feedline ahead of the preamplifier, as shown in Fig. 2, the noise-figure increases to 10.59 dB. As you can see, the noise-figure is improved by 6.6 dB by putting the element with the lowest noise-figure (the preamp) first. A general rule of thumb in receiver design is that each stage should have at least 10 dB more gain than the noise-figure (in dB) of the subsequent stages of the receiver. By placing the preamp first we eliminate the noise-factor and attenuation effects of the feedline, because the preamp has a gain of more than 10 dB over the losses induced by the feedline.

Another benefit of having the pre-amplifier located at the antenna is improved flatness of the transmission line's VSWR (Voltage Standing Wave Ratio); even the best antenna designs do not have a constant feedpoint impedance over their frequency range. The result is that the VSWR of the feedline varies with frequency. Two adverse effects of a high VSWR are increased losses, and reflections that degrade picture quality—especially in the case of color. With the preamp, however, it is easy to design a broadband output-circuit, thus making the match to the line better and lowering the VSWR on the longest part of the feedline. The antenna will still exhibit whatever mismatch characteristics it has, but the resulting mismatch will occur only on the portion of the line between the antenna and preamplifier. That will be of little consequence, because of the short line-length involved, and the pre-amplifier will effectively buffer the remaining feedline to the set or distribution system.

Commercially available UHF preamps have gains ranging from 12 to 22 dB with noise-figures in the range of 3 to 8 dB. (You can perform gain and noise calculations as shown above using the appropriate figures).

#### A preamp you can build

You can improve your UHF reception for less than \$35.00. The preamp

#### PARTS LIST—PREAMP

All resistors 1/8 watt, 5%

R1—82,000 ohms

R2—820 ohms

R3—39,000 ohms

R4—390 ohms

**Capacitors**

C1, C2—3.3 pF chip capacitor

C3, C4—2.7 pF chip capacitor

C5, C6—680 pF, ceramic disc

C7—0.01 μF, ceramic disc

**Semiconductors**

Q1, Q2—BFQ85 or BFR90

L1—L3—See text

L4—10 μH choke (3½ turns No. 30 wire-wrap wire through 1/8-inch ferrite bead)

J1, J2—bulkhead-mount female "F" connectors

**Miscellaneous:** Double-sided PC board (etched one side), enclosure, solder, etc.

A kit of all parts for the UHF preamp, including power supply and balun (the balun will be discussed next month), is available for \$34.50 plus \$2.00 for shipping and handling. An assembled version is available for \$47.50 plus \$2.00 for shipping and handling. Both are available from:

RaySon Electronics Corp.

1010 12th St., Suite 5

Sparks, NV 89431

Micromart

508 Central Avenue

Westfield, NJ 07090

(201) 654-6008

Quest Electronics

P.O. Box 4430

Santa Clara, CA 95054

(800) 538-8196 (except CA)

(408) 988-1640

All suppliers accept MC and Visa. Please add sales tax where applicable.

that will do the job is unusual because, for its price, it provides exceptional gain (25 dB typically) with an exceptionally low noise-figure (only 3.5 dB, maximum). Its performance exceeds that of any of the under-\$100 commercial preamps tested by the FCC. While the device is intended to be used outdoors as an antenna-mounted unit, it can also deliver reasonable performance if used indoors at the TV receiver.

Several factors contribute to its high performance, the primary one being use of two microwave-type transistors. Those devices are useful up to 1.5 GHz and have a noise-figure of less than 2 dB over the entire UHF-TV spectrum. Figure 3 shows gain vs. frequency and noise-figure vs. frequency plots for the transistors. (They are actually integrated circuits that have broadband impedance-matching networks right on the chip.) The devices have nominal input and output impedances of 75 ohms, so no tuning is required and circuits built around them are extremely stable.



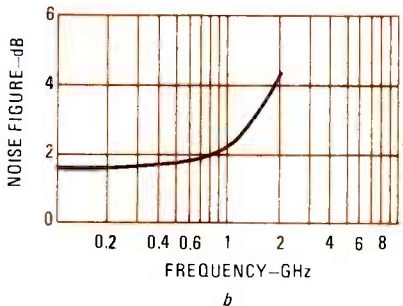
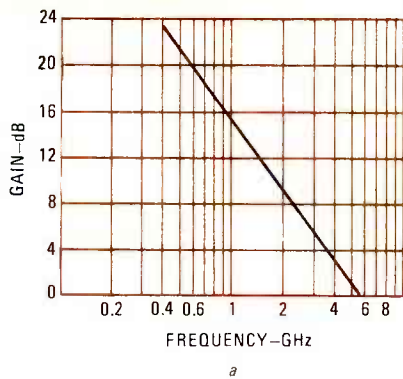

FIG. 3—TRANSISTORS USED IN PREAMP show excellent gain-vs.-frequency (a) and noise-figure-vs.-frequency (b) responses.

The second contributing factor to that preamp's performance is the PC board's design; the RF path on the board is actually a 75-ohm transmission-line section, or *stripline*. The use of stripline construction continues the 75-ohm transmission line right to the input and output terminals of the transistors, thus insuring proper impedance-matching to the devices for optimum performance. To take maximum advantage of the stripline construction, the RF coupling-capacitors are micro-wave chip-capacitors, which are designed to be integrated into the stripline with a minimum of disturbance in the line's characteristics. Stripline construction is used almost exclusively in microwave equipment and this preamp makes an ideal project for experimenters to gain experience with microwave-equipment construction techniques.

Figure 4 shows a schematic of the circuit. The input and output circuits are both 75 ohms. (Since we discussed the differences in losses between wet 300-ohm twinlead and wet 75-ohm coax earlier, there should be no doubt as to why the output cable to the TV set should be coaxial cable).

The first stage of the preamp is biased for a collector current of approximately 4 mA for the best noise-figure, and the second stage is biased for a collector current of approximately 10 mA for optimum gain. The input filter, consisting of C1, C2, and L1, is a high-pass filter that rejects anything below about 500 MHz. While that frequency falls

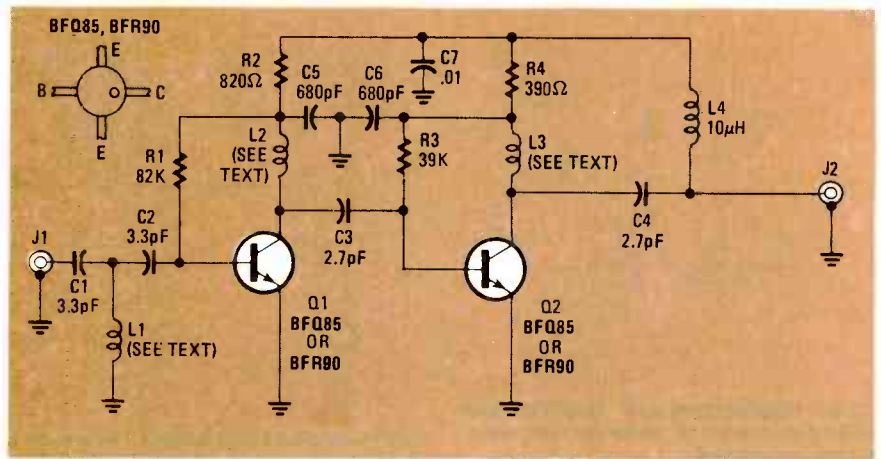

FIG. 4—FIRST STAGE OF PREAMP is biased for optimum noise-figure; second stage for optimum gain.

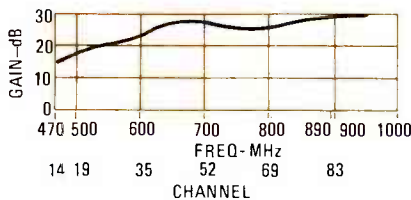

FIG. 5—HIGH-END RESPONSE of preamp is in excess of 25 dB.

around channel 20, the rolloff characteristics are sufficiently broad for the amplifier to have a gain of 15 to 18 dB at the low end of the UHF band. Considering the overall response of a typical antenna, feedline and TV tuner, the low-end rolloff of the amplifier is more than offset by the higher response of the other system components. The amplifier's frequency response is shown in Fig. 5, a normalized response-curve for three prototypes tested. It should be noted that the high-end response is better than 25 dB even at channel 70, a feature that is not found in many commercially-available amplifiers; many of them roll off sharply before channel 60.

### Preamp construction

Figure 6 is a foil pattern for the stripline preamplifier. For the stripline section to exhibit the desired characteristics, the board material must be glass-epoxy *double sided* material, 1/16-inch thick.

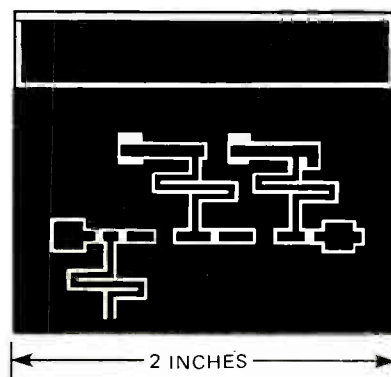

FIG. 6—PREAMP IS CONSTRUCTED on double-sided PC board, only one side of which is etched.

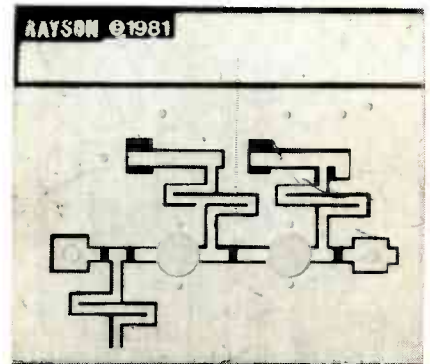

FIG. 7—BARE PC BOARD shows where holes for "F" connectors, transistors and disc capacitors are drilled.

The three elongated "S"-shaped sections are inductors L1, L2, and L3; L4 is made by winding 3½ turns of No. 30 wire-wrap wire through a small (1/8-inch) ferrite bead. The bead should be located as close to J2 as possible.

The input and output connectors are F-type connectors that are soldered to the rear (unetched side) of the board, with the center pins passing through the board directly into the stripline sections. The copper around the two center-conductor holes on the rear must be removed so the pin will not short out against it. That is easily done by hand with a 1/8-inch or larger drill bit. Apply pressure gently while twisting it in the hole—the foil will be removed and the insulating glass-epoxy board exposed. Stop there—you don't want to weaken the material. Figure 7 shows the large and small holes that have to be drilled for the jacks, transistors, and disc capacitors.

Assembly is reasonably straightforward; Fig. 8 shows the component placement. The two emitter leads on the transistors are bent at right angles just beyond the point where they narrow. The base and collector leads are cut short at the same point. The transistors are inserted into the holes in the board from its etched side with the collector lead (marked by a dot on the case) facing down and toward the out-

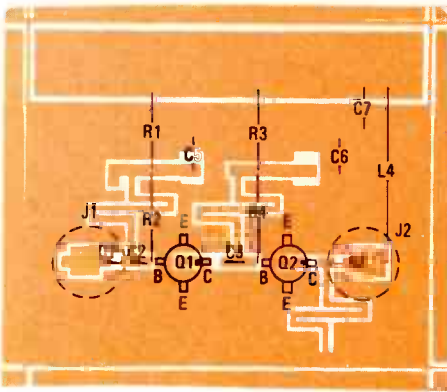

FIG. 8—TRANSISTORS ARE MOUNTED from etched side of board. "F" connectors are mounted from unetched side.

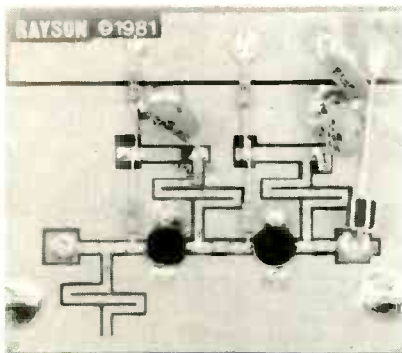

FIG. 9—MOST COMPONENTS are tack-soldered to etched side of board. Exceptions are disc capacitors, transistors, and connectors.

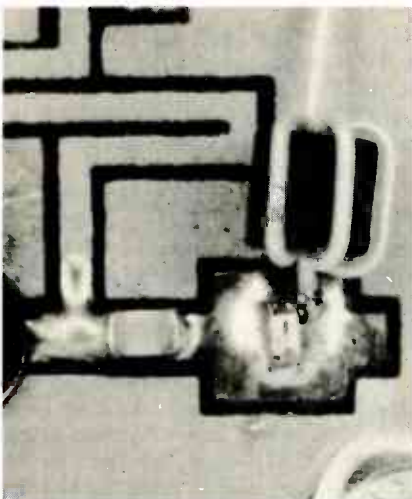

FIG. 10—CLOSE UP OF BOARD shows choke L4 and small chip capacitor to its right. See text for details on soldering chip capacitors.

put connector (J2). The emitter leads must be passed through the board and soldered on both sides of it. The other transistor-leads should lie flat against the stripline section.

While it is possible to use ¼-watt resistors, ½-watt units have been found to give better performance. Keep all leads as short as you can.

The chip capacitors have to be very carefully installed. They are extremely small and light, and the surface tension of molten solder will cause them to

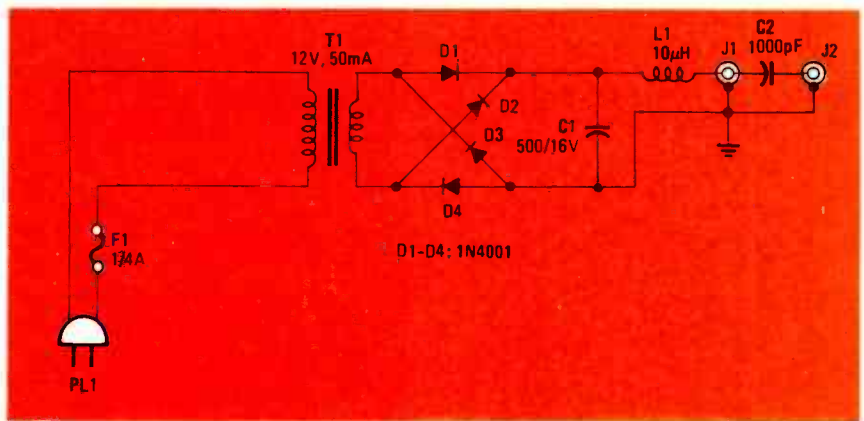

FIG. 11—SIMPLE POWER SUPPLY for preamp. If desired, an off-the-shelf 9-volt wall-plug DC supply can be used, or 12-volts taken from TV set providing it is not "hot chassis" type.

### PARTS LIST—POWER SUPPLY

#### Capacitors

- C1—500 µF, 16 volts, electrolytic
- C2—1000 pF, ceramic disc

#### Semiconductors

- D1—D4—1N4001
- L1—10 µH choke (3 ½ turns No. 30 wire-wrap wire through ⅛-inch ferrite bead)
- T1—12 volts, 50 mA or greater
- F1—¼ amp fuse

J1, J2—female "F" connectors

Miscellaneous: baluns (see text), wire, solder, etc.

stick to the tip of the iron. To mount them on the board, you should work slowly and carefully with a fine tip on the iron and fine-gauge solder. Apply a very small amount of solder to the PC board first, and then, with a pair of tweezers, carefully position one end of the capacitor against it. Heat the solder momentarily with the iron until the solder flows, and hold the capacitor in position with the tweezers while you remove the iron. That will tack one end of the capacitor to the board and then you can go ahead and solder the other end.

The two sides of the board have to be connected for best operation. That is easily done by forming two short lengths of wire (resistor leads, for example) into "U"s, slipping them onto the board with one leg of the "U" on each side of it, and soldering. The "U"s should be located as close as possible to the input and output jacks.

The circuit can be assembled in less than an hour, and once it's together, it's ready to use. The completed board is shown in Fig. 9. (Note that two of the holes shown in Fig. 7 are not used.) A close-up view of coil L4 and one of the chip capacitors is shown in Fig. 10.

Since the preamp is a broadband device, there is no tuning or alignment required. It should be mounted in an enclosure; the two coaxial connectors secure it to that enclosure. The box can be either metal or plastic, and the

preamp can be used either indoors or outdoors. Best results are obtained when the preamp is mounted right at the antenna, but in many instances, good results can still be obtained with the preamp mounted indoors near the TV set. An interesting combination for indoor use has the stripline pre-amplifier with the \$6.95 Radio Shack 15-623 antenna. Georgia Tech engineers rated that antenna as "...significantly superior to other indoor antennas evaluated."

### Power supply

The preamp requires approximately 12-volts DC for operation. The voltage is not especially critical, and the pre-amp will operate reasonably well at any voltage between 9 and 15 volts; however, the best noise-figure is attained at 12 volts. The power is run up the feed-line. Choke L4 on the preamp board prevents the output signal from flowing into the power bus, while C4 blocks the DC from being short circuited by Q2.

The preamp requires only 15 mA for operation. Figure 11 shows the circuit for a power supply that can be used to power the unit, and a means for connecting the 12-volts to the set end of the cable. J1 connects to the preamp and J2 connects to the set.

If you do not want to build your own supply, you can use a small wall-plug DC supply. A 9-volt, 100-mA supply will deliver between 12 and 14 volts when lightly loaded. Surprisingly, 200-mA supplies provided only 11 to 12 volts under the same conditions. However, either would be adequate—there is little difference in performance apparent with supply voltages between 9 and 15 volts.

If you're careful, power can also be "stolen" from the TV set itself if it is not of the hot-chassis type.

You'll need to modify a commercially available balun for use with the preamp. We'll show you how to do that, and some things to consider when selecting an antenna and feedline, when we continue this article.

R-E



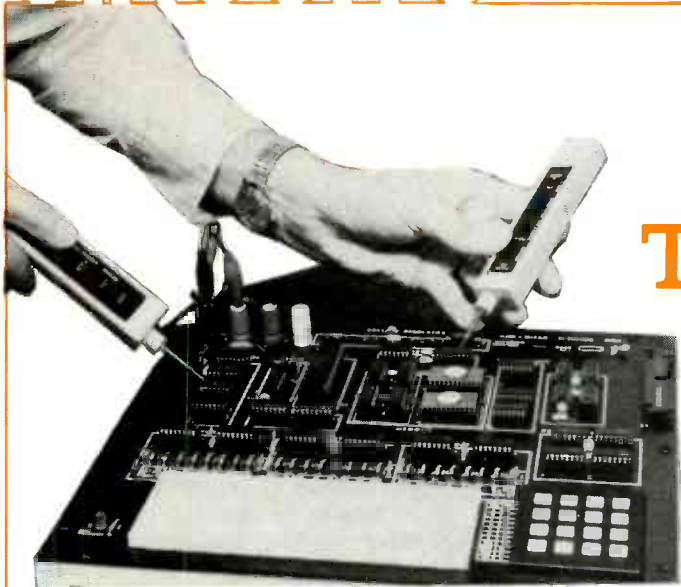

## Troubleshooting DIGITAL CIRCUITS

*Troubleshooting procedures and tools for digital logic-circuits are quite different from those used in analog work. Here's an introduction to working with digital IC's.*

ROBERT L. GOODMAN

THE DIGITAL INTEGRATED-CIRCUIT HAS revolutionized the electronics industry and, in many areas, now dominates it. Because of the digital explosion, you will find more compact, complex, and powerful troubleshooting instruments and devices. Unfortunately, the digital-IC boom has given a big headache to the analog-circuit troubleshooter. Because of the fundamental differences between analog and digital circuits, the troubleshooting techniques and the types of instruments that must be used differ greatly from those required in analog work. One of the first, and most useful, tools you will encounter in troubleshooting digital-logic circuits is the logic probe.

### About logic probes

Digital logic works using two voltage levels to express either an "on" or an "off" state. "On" is usually in the neighborhood of +5 volts, and is referred to as a *logic-high* state or "1." "Off" is at or near 0 volts, and is called a *logic-low* state or "0." We'll go into more detail on the workings of digital logic later.

Logic probes quickly tell you how—or whether—a digital circuit is operating at the point being tested by indicating what logic state is present. Suppose, for example, that a test point is supposed to go to a logic-high state under certain conditions. A logic probe will indicate whether or not the line actually does go high when it's supposed to, or whether

it is, perhaps, permanently at a logic-high level.

Some probes have a memory function and can be used to monitor a line for intermittent pulses, or noise spikes ("glitches") that can upset logic-circuit operation.

Logic probes are powerful troubleshooting tools because of their portability, low price, and simple operation.

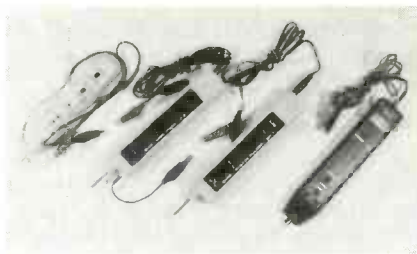

FIG. 1—SOME OF THE logic probes and pulsers used for digital troubleshooting.

Most logic probes provide the following features:

- High or low pulse-indication
- Pulse-train indication
- Stretching capability for short pulses
- 10 nanosecond pulse-response
- Pulse memory
- Undefined logic-state indication
- Ability to test different logic-families

Figure 1 shows a few of the various logic probes that are available. From left to right they are the Global Specialties Corp. model *LP-1* and *LP-2* logic probes, the *DP-1* pulser, and B&K-Precision's model *DP-50* logic probe.

### Using a logic probe

Logic probes indicate logic states with lamps or LED's. Some use colored LED's in various patterns to show logic states. The LED's show whether a logic state is high, low, or alternating (pulsing); or whether an open circuit exists.



FIG. 2—GLOBAL SPECIALTIES' *LP-2* logic probe, like most others, derives its power from the circuit under test through clip leads (top).

The Global Specialties *LP-2* logic probe shown in Fig. 2 is protected against over-voltage and reverse voltage that might be applied to its power leads. To use the probe, connect its black-clip lead to the power-supply common (–) and the red-clip lead to  $V_{cc}$  of the system under test. In order to minimize the possibility of power-supply spikes or other spurious signals

from affecting the operation of the probe, connect the power leads as close to the point being tested as possible.

The B&K-Precision DP-50 digital probe (shown in Fig. 3) is designed for quick analysis of digital circuits, and is compatible with TTL, DTL, RTL, CMOS and high-noise-immunity logic. Three LED's at the probe-tip indicate the presence of digital pulses, and high and low logic-states. Two switches allow you to select TTL or CMOS logic-thresholds, and PULSE STRETCH or MEMORY modes. In the PULSE STRETCH mode, short-duration pulses are stretched for a clear visual indication. In the MEMORY mode, a single digital pulse will cause an LED to remain lit until the memory circuit is reset. The probe thus has the ability to "freeze" an indication of digital-logic action.

### Pulse stretching

Probably one of the most important features of a logic probe is its ability to "stretch" a 10-nanosecond (ten-billionths of a second) pulse to 100 milliseconds so that the LED will stay illuminated long enough to be observed. That pulse stretching is accomplished by using the leading edge of the short pulse detected to trigger a flip-flop whose time delay is 100 ms. Single pulses flash the probe's LED's once, while trains of pulses will usually cause them to blink at a 10-Hz rate, regardless of pulse-frequency. Generally, just knowing that pulse activity is present is enough. (If the pulse-frequency is important, use a frequency counter or oscilloscope.)

### Digital vs. analog troubleshooting

When troubleshooting circuits containing analog devices, you usually need only test resistance, capacitance, or voltages. The total circuit may be quite complex, but each component in the circuit performs a simple task and its operation can usually be checked out easily. If necessary, each resistor, capacitor, diode, and transistor can be tested individually by using a signal generator, VTVM or DMM, diode checker, or scope, together with conventional troubleshooting techniques. With integrated circuits, though, it is impossible to check the individual components on the chip; you must troubleshoot the device as a whole.

A significant difference between circuitry made up of discrete components and digital IC's lies in the complexity of the functions performed by the latter. Instead of measuring simple characteristics, you need to observe complex and rapidly occurring digital signals and to determine whether they're correct.

Verifying proper digital-IC operation requires observing several inputs while simultaneously observing two or more outputs. Thus another difference between analog circuitry built from discrete components and digital IC's is the



FIG. 3—SWITCH-SELECTABLE threshold levels (TTL/CMOS) are common on logic probes such as B&K-Precision's DP-50.

number of inputs and outputs for each component and the need to check them simultaneously.

Digital IC's contain many complex circuits. Should any portion of such an IC fail, it would be difficult to pinpoint the area of failure—and impossible to repair or replace it (you can rebuild picture tubes, but not IC's). Consequently, to troubleshoot circuits made up of digital IC's involves locating not a portion of an IC that's gone bad, but, rather, just the IC itself. Replacing it usually restores the circuit to working order.

For effective troubleshooting of digital circuits, it is necessary to take advantage of the digital nature of the signals involved. Tests and techniques to troubleshoot analog circuits do not do that and are inefficient when used for digital circuits.

### TTL logic-signals

A typical TTL (Transistor-Transistor Logic—the most common digital-logic family) logic signal is shown in Fig. 4. The appearance of a similar pulse-train on the screen of an oscilloscope is shown in Fig. 5. The scope displays voltage with respect to time, but for digital pulses, exact values are not important. A digital signal exists in one of two or three states—high, low, or undefined (in-between states)—each determined by a threshold voltage. It is the value of the signal voltage *with respect*

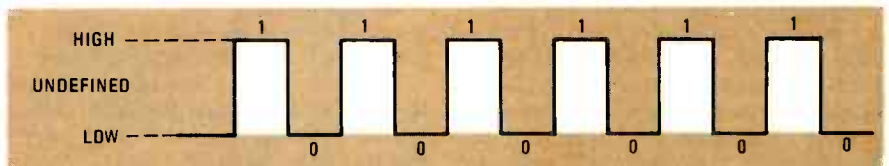

FIG. 4—TRAIN OF DIGITAL PULSES consists of a square wave whose values alternate between (approximately) 5-volts and 0-volts.

to those thresholds that determines the logic-state of a digital signal.

As Fig. 6 shows, if the signal level is greater than 2.4 volts, it is considered to be a logic "high." For a logic "low" the voltage must be below 0.8 volts. The precise value is not important as long as it is above or below the threshold, and not in the "undefined" area. When using a scope, you must always determine whether the signal meets the threshold requirement for the desired digital state; a logic probe will tell you that.

Each gate in a TTL logic family has a certain propagation-delay time, rise time, and fall time. Those times rarely change, so scope checks of timing parameters contribute very little to the troubleshooting process.

The circuit in Fig. 7, showing a simple TTL totem-pole device (the output transistors are "stacked" like a totem pole, hence the name), illustrates a problem created by the TTL logic-family. In either state—high or low—it has a low output-impedance. In the low state that is about 5 or 10 ohms to ground.

That presents a problem for in-circuit pulse injection (used to determine how the device is operating by "force-feeding" it a pulse). A device used to inject a pulse at a point that is driven by a TTL output must have sufficient power to override the low-impedance output state. Most signal sources used for troubleshooting do not have that capability. Thus the troubleshooter is forced either to cut the printed-circuit runs or lift IC leads in order to pulse the circuit to be tested; that is time consuming and also can damage other circuits.

For those reasons a scope and traditional signal-sources are not very useful. And, since many diodes and transistors are packaged in the IC, diode checkers are largely useless. With the complexity of today's electronic circuits, it makes good sense to find the most efficient troubleshooting method. In most cases, oscilloscopes, diode checkers, and voltmeters are best suited for use with analog circuits, where they really shine. Special-purpose equipment, such as logic probes and pulsers (see below), should be used when working on digital equipment.

Logic probes provide a quick way not only to detect, but also locate, breaks in a PC run. Since an open signal-path may allow IC inputs at the break to "float" to an undefined state, a logic probe can be used to test the input of each IC for such a state. Once a floating input is detected, the logic



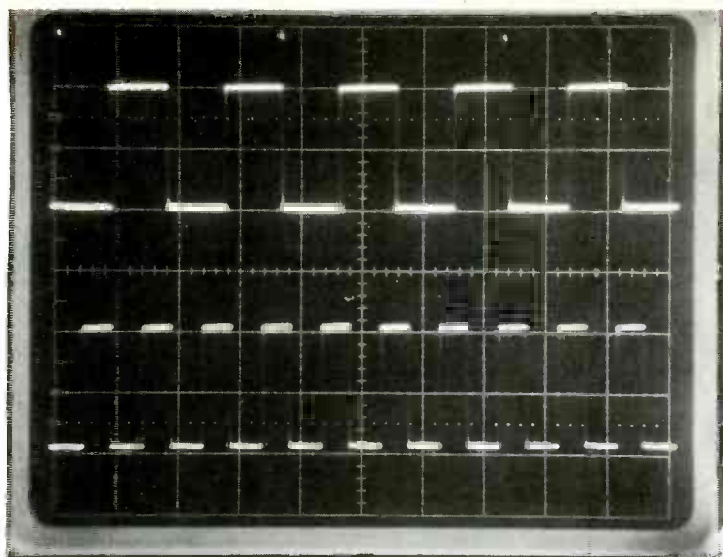

FIG. 5—DUAL-TRACE SCOPE shows two trains of pulses. Vertical lines in square wave are nearly invisible because transition between states is extremely fast.

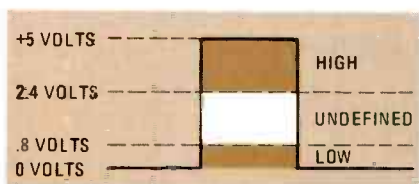

FIG. 6—VOLTAGE THRESHOLDS determining logic states. Contrary to popular belief, a logic "high" is not always 5-volts.

in the internal circuitry (often called the steering circuitry) of the IC.

In addition to those four internal failures, there are four types of faults that can take place in the circuitry external to the IC. They are: (1) a short between a signal path and  $V_{CC}$  or ground, (2) a short between signal paths, (3) an open signal path, and (4) a failure of an

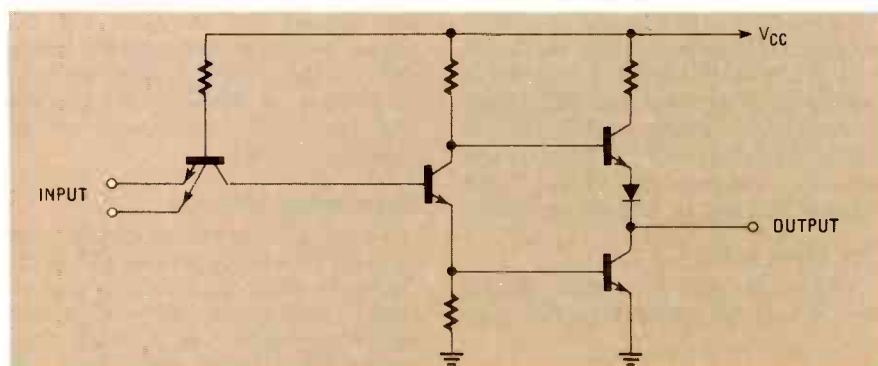

FIG. 7—TWO-INPUT NAND GATE. Totem-pole configuration at output results in low impedance, making some conventional tests difficult to perform.

probe can be used to follow the circuit back from the input searching for the break. That can be done because the circuit before the break will show valid logic levels (either high, low, or pulsing) while the circuit after the break will probably show undefined levels.

#### IC failures

To troubleshoot digital-IC circuits, it is important to know what types of faults to expect. They can be divided into two main classes—those caused by failures inside the IC, and those caused by circuit failures outside the IC.

There are four types of internal IC-failure: (1) an open bond at either an input or output, (2) a short between an input or output and  $V_{CC}$  or ground, (3) a short between two pins, and (4) a failure

analog component, such as a resistor, capacitor, or semiconductor device.

#### Logic pulsers

Logic pulsers inject a single pulse of the proper amplitude and polarity into a circuit. If a point was at a logic-"low," it will automatically be pulsed high, and if it was high it will be pulsed low. Pulsers are useful for forcing the inputs of digital IC's to change state so that the resulting outputs can be observed. Pulsers have a high current-output, but use a low duty-cycle to protect the IC's from damage.

In their many applications, digital IC's have certainly made our lives easier. Knowing how they work and how to troubleshoot them should make *your* life easier, too.

R-E

**This Publication  
is available in  
Microform.**



**University Microfilms  
International**

Please send additional information  
for \_\_\_\_\_  
Name \_\_\_\_\_  
Institution \_\_\_\_\_  
Street \_\_\_\_\_  
City \_\_\_\_\_  
State \_\_\_\_\_ Zip \_\_\_\_\_

300 North Zeeb Road  
Dept. P.R.  
Ann Arbor, Mi. 48106

## ALL ABOUT PULSE GENERATORS



Once found only in sophisticated design labs, the tremendous growth in the use of digital circuits and devices has made the pulse generator a valuable instrument for any service shop or experimenter's workbench.

CHARLES GILMORE

NOT TOO LONG AGO THERE WERE FEW pulse generators outside of sophisticated design laboratories. Today, they are found in service shops, on experimenters' benches, and anywhere else that electronics testing is done. Two factors have influenced the wider use of those instruments: need and lower prices. The dramatic growth in the use of logic circuits caused the need; the price-drop soon followed, and pulse generators are now truly low-cost signal sources.

Not long ago, few pulse generators were available for under \$1000. Now, there are many available for under \$400. Although many sophisticated, and expensive, pulse generators are still available, the lower-priced units have enough features to make them extremely useful.

Currently, the need for a pulse generator arises mostly from the extensive use of many different varieties of digital logic in industrial, laboratory, and consumer applications (although a pulse generator is also useful when working with analog circuits). It is not possible to service or design logic-based electronic systems using only a sine-wave generator or a square-wave generator. A sine-wave generator or square-wave generator cannot vary the pulse width of its output signal; it also cannot generate a wide enough range of frequencies. In addition, frequently the output impedance of a sine-wave generator or a square-wave generator is not low enough to drive logic circuits.

A more elaborate function generator with DC offset, variable symmetry control, and a wide frequency range may fulfill the need for a pulse generator

partially, if the requirements are simple. When extensive use of logic circuits is involved, however, a function generator is not adequate. Function generators cannot produce pulses of less than 5% duty cycle, and low-cost or reasonably priced units do not provide the 10-MHz to 20-MHz capability required of pulse generators used with TTL (Transistor-Transistor Logic) or ECL (Emitter-Coupled Logic) systems. Of course, the function generator contains many other features that may or may not be needed.

### The basic pulse

Before discussing the pulse generator, it may help to review the basic

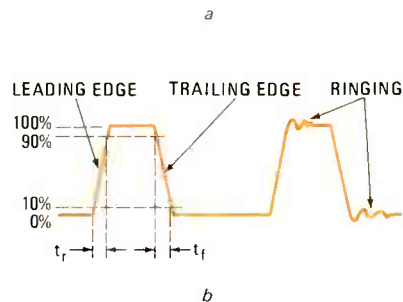
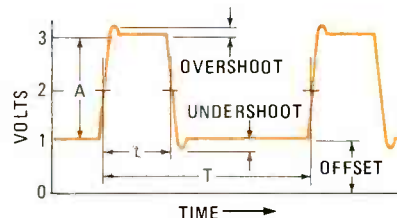

FIG. 1—THE TIMING AND AMPLITUDE relationships of a basic pulse are shown in a. A pulse with exaggerated leading and trailing edges is shown in b.

characteristics of a pulse. Figure 1 shows the basic timing and amplitude relationships of a pulse. In Fig. 1-a, the period between the start of each pulse is a length of time,  $T$ , that is considerably greater than the pulse width,  $t$ . Figure 1-b shows exaggerated leading and trailing edges to illustrate such parameters as rise-time and fall-time. The basic pulse parameters are explained in Table 1.

### Basic pulse generator

Figure 2 shows a simplified block diagram of a pulse generator. The circuitry for each block is fairly conventional. Numerous outputs, special buffer amplifiers, and power supplies can be added to each stage to reach the level of sophistication needed for a particular application.

The basic pulse repetition rate is controlled by the *repetition-rate generator*—a free-running astable multivibrator capable of covering the frequency range required by the pulse generator.

Pulse generators offer a switch-selected alternate source for rate generation called the *external trigger*. Signals applied to the external trigger input pass through triggering circuitry much like that found in an oscilloscope. Those circuits establish the triggering amplitude and polarity. Additional inputs to the trigger amplifier may include a line-frequency source and a manual pushbutton for one-shot operation.

A second external amplifier can be used to gate the main repetition-rate generator in a manner similar to the gated mode of function generators. Signals from the gating amplifier permit



TABLE 1

**Pulse period**—pulse period  $T$  is the time between two pulses. It is measured between either the leading or trailing edges.

**Repetition rate**—indicates the number of pulses over a fixed period of time, usually 1 second. The repetition rate depends on the pulse period  $T$ : Repetition rate =  $1/T$ .

**Pulse width**—the time between the 50% amplitude points of any single pulse is defined as the pulse width  $t$ .

**Pulse amplitude**—pulse amplitude  $A$  is the voltage to which the pulse rises above its own baseline, measured after any overshoot has been reduced to zero.

**Pulse offset**—the value and polarity of the difference between the pulse baseline and 0 volts.

**Overshoot**—that portion of a pulse at the end of the leading edge, where the leading edge extends above the normal pulse amplitude. Overshoot is usually expressed as a percent of total amplitude.

**Undershoot**—that portion at the end of the trailing edge where the trailing edge extends below the baseline. That is usually expressed as a percent of pulse amplitude.

**Leading edge**—the portion of the pulse where a negative-to-positive transition occurs.

**Trailing edge**—that portion of the pulse in which the positive-to-negative transition occurs.

**Rise time**—the time required for the pulse to pass from 10% of total amplitude to 90% of total amplitude ( $T_r$ ).

**Fall time**—the time required at the trailing edge for the pulse to pass from 90% of full amplitude to 10% of full amplitude ( $T_f$ ). Rise time and fall time are not necessarily equal.

**Ringling**—damped oscillation at the end of the leading or trailing edge of the pulse.

**Duty cycle**—the ratio of pulse width to the pulse period, expressed in percent. Sometimes that is referred to as the duty factor.

**Pulse polarity**—indicates whether the desired pulse extends positively or negatively with respect to the baseline. Pulse polarity is independent of the absolute DC-value of the baseline.

the repetition-rate generator to output pulses only when a gating signal is applied; otherwise no pulses are generated. A burst of pulses can be produced in that mode.

Signals from the repetition-rate generator or from the trigger circuits are applied to the delay generator (if the pulse generator has one). The delay generator is a wide-range monostable multivibrator.

Once the delay generator has completed its cycle, the main pulse generator is triggered. The pulse generator is also a monostable multivibrator with a wide dynamic range to generate the necessary pulse widths. That monostable multivibrator can be quite sophisticated.

It must cover an extremely wide range of pulse widths (typically 7 to 8 decades) and operate at fairly high duty-cycles. Some generators need to operate at duty cycles that are greater than 100%. The output stages of the monostable multivibrator may include independent charge and discharge switches so that independently variable rate times and fall times can be generated. That feature is usually found only on more expensive pulse generators.

The output of the monostable multivibrator is applied to one or two output amplifiers. Those amplifiers must be DC-coupled, variable-gain wideband amplifiers. On more sophisticated generators, where extremely close control

of pulse characteristics is desired, two amplifiers are used. One of the amplifiers handles the positive pulses; the other handles the negative pulses. In that manner, each amplifier can be tailored to its particular function. In other pulse generators, a single amplifier is used. In either case, extremely wide-band amplifiers must be used to reproduce faithfully pulses whose rise times lie in the nanosecond range, without ringing or other aberrations.

Pulse amplitude is usually regulated solely by a variable-gain control that is part of the output amplifier. A few of the higher-priced pulse generators include a step attenuator at the output. As the output amplifier is DC-coupled, a DC offset signal can be applied to the amplifier, along with the pulses, so that the pulse baseline can be changed with reference to 0 volts. Normally, the offset voltage is unaffected by adjustments of the continuously variable output attenuator.

Pulse generators that include a delay-generator frequently have a specialized mode referred to as a double- or twin-pulse mode. In a double-pulse mode, the main pulse generator is triggered not only by the delay-generator output, but also by the signal directly, at the same time that the signal triggers the delay generator. The result is two pulses, the first, generated at the time of triggering, and the second, at the time the delay generator has completed its cycle.

There are many special applications that require a capability other than those offered by a standard pulse-generator. For such applications, certain portions of the basic pulse generator can be adapted to accommodate those special requirements.

**Word generators**

The word generator is one of those specialized versions. Its function is to generate a series of pulses that form a serial digital word. Usually, those generators are operated in either a one-shot or a repetitive mode. The pulse-generator circuitry (a simple monostable multivibrator) is replaced by a more sophisticated circuit that is capable of producing a series of pulses. Usually 8, 16, or 32 pulses-per-trigger-signal are produced.

**High-speed pulse generators**

Two types of pulse generators fall into the high-speed category. Pulse generators whose repetition rates are in the 100-MHz to 250-MHz range are designed especially for working with extremely high-speed ECL circuitry.

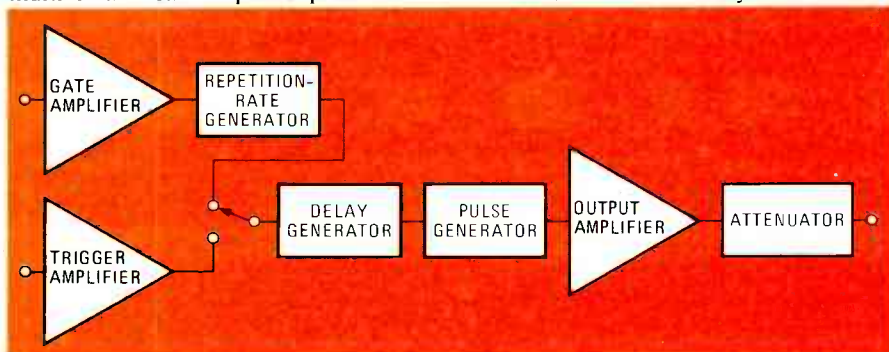

FIG. 2—SIMPLIFIED BLOCK DIAGRAM of a basic pulse generator is shown here. Many outputs, special buffer amplifiers, and power supplies can be added to each stage to make a more sophisticated instrument.

They are particularly useful when designing or servicing complicated portions of high-speed computers and some instruments. Because of their high repetition rates, high-speed pulse generators require that all circuitry within the pulse generator perform many times better than the circuitry of a conventional pulse generator.

Pulse generators may also be required to produce pulses with extremely fast rise-times. The conventional pulse generator has typical rise times in the range of 5 to 7 nanoseconds. Rise times that are measured in hundreds of picoseconds are available with specialized pulse-generators. Pulse generators with those fast rise times generally do not have variable rise-time and fall-time capability.

### Pulse-burst mode

The pulse-burst option permits you to select the number of pulses that are generated when a trigger signal is received. That mode differs from the word generator in that the logic state of each pulse is not controlled individually. However, you can trigger from 1 to 10,000 pulses in a single burst. The pulse-burst mode is particularly convenient when you are working with counters or other circuits where response to the wave-shape and repetition rate, as well as to a particular number of pulses, is important.

### High-voltage generators

High-voltage outputs on pulse generators are becoming less and less common. However, pulse generators designed for certain communications, biological, or physiological applications, and those to be used with tube-type circuits, may have very high voltage-signals. Usually, such pulse generators are severely limited in terms of rise time, pulse-repetition rate, and output impedance.

### Pulse-repetition rate

The controls that vary the pulse-repetition rate on most generators consist of a decade switch combined with a continuously variable control. Repetition-rate specifications include the minimum and maximum frequency capability, and the number of decades involved. Maximum repetition rates of 10 to 20 MHz are typical of low-cost generators. A few of those generators have maximum repetition rates that extend to 50 MHz. The minimum repetition rates of pulse generators vary widely. Some low-cost generators can have a minimum repetition rate of as little as 0.1 Hz, while others have minimum repetition rates that are as high as 10 Hz.

The selection of a repetition rate must be made with the application in mind. If the generator is to be used for

TTL or ECL logic analysis or servicing, a maximum repetition rate of at least 10 MHz is a must; 20 MHz is certainly more desirable. Minimum repetition rates are not tied to any particular logic-family type, but depend on the application. For most applications, a minimum repetition rate of 5 to 10 Hz is sufficient. For special applications, however, lower repetition rates may be needed. Extremely low repetition rates can be obtained by triggering the pulse generator from an external low-frequency source, such as a function generator.

The repetition-rate specification is not always given as the frequency. Some manufacturers list it as a repetition rate or frequency; others supply the information as a pulse period or time specification. The conversion between pulse period  $T$  and frequency  $f$  is easily made by the relationship:

$$T = 1/f$$

Repetition-rate accuracy is rarely specified on low-cost pulse generators. Where it is specified, it is indicated as a percentage of the maximum range. The accuracy of the repetition-rate setting is very unreliable, and whenever an accurate pulse-repetition rate is needed, it should be obtained either by triggering the pulse generator from a known frequency source, such as a signal generator, or by measuring the repetition rate at the trigger output, using a digital frequency meter or oscilloscope. Extremely low repetition rates may require using a digital period meter.

Repetition-rate jitter refers to the consistency of the period from one set of pulses to another. Jitter is caused by noise in the pulse-repetition-rate generator, and is specified as a percentage of the repetition rate or period. Although not specified on many low-cost pulse generators, repetition-rate jitter is typically 0.1% to 0.5%. That specification may include a fixed minimum amount of jitter in addition to the percentage of repetition-rate setting. Repetition-rate jitter does not decrease dramatically with the increased price of a generator.

### Pulse characteristics

The most important pulse characteristic in most applications is the pulse-width range, which is usually controlled in the same way as a repetition-rate generator—that is, in decade steps with a continuously variable control covering the range between each step. Pulse-width controls frequently do not have accuracy specifications, and when such specifications are given, an accuracy of pulse-width settings on the order of 10% to 15% can be expected. Once again, like the pulse-repetition rate, the pulse width must be closely monitored by a digital period-meter, or by an oscilloscope, to achieve more precise settings. Pulse-width characteristics of generators cover a

fairly wide range.

The narrowest pulse obtainable varies between 10 and 15 nanoseconds. Almost all low-cost generators have the same minimum pulse width but the maximum pulse width varies widely from manufacturer to manufacturer. Typically, the maximum pulse width varies from 10 milliseconds to 10 seconds. In most cases, narrow pulses are needed, and generators that produce pulses with minimum widths of 10 to 15 nanoseconds are suitable for use in most TTL (and some ECL) systems. For most general applications, a pulse generator is suitable if it can generate pulses with widths of at least 100 milliseconds. Pulses that are wider than that (from 100 milliseconds to 10 seconds) may be convenient for certain applications, but in general, they are not widely used.

Some manufacturers provide a pulse-width jitter specification that is fairly similar to that of the pulse-repetition rate, and indicates the maximum variation in width from pulse to pulse that can be expected. Pulse-width jitter specifications normally range from 0.1% to 0.5%.

Pulse rise-time is an important specification. To be suitable for high-speed logic operation, pulse rise times and fall times must be less than 10 nanoseconds, with 5 to 7 nanoseconds being a typical specification.

The maximum duty cycle is usually listed as a pulse specification. Most pulse generators are limited to duty cycles of 70%. Some special-purpose pulse generators offer duty cycles of up to 100%. The maximum duty cycle usually decreases at the high repetition-rate settings.

Leading-edge and trailing-edge overshoot and undershoot are specified as a percentage of the maximum permissible output-amplitude. Those, like many other specifications, are only valid when the pulse generator output is terminated into its characteristic impedance.

### Delay generator

Specifications for a delay generator are nearly similar to those for the main pulse generator. That is, they specify delay width, although the range of that width is usually much more limited than that of the main pulse generator itself. Jitter specifications can also be applied to the delay generator. Adjustments to the delay generator's operating parameters are made the same way as those that are made for the main-pulse generator. The controls for both parameters (pulse width and jitter) are not interactive.

Next month, we'll continue our look at pulse-generator characteristics, and begin to look at some applications for those devices.

R-E



# Here's why we're Number One.

When it comes to logic probes, more people purchase Global Specialties! Because you can spend twice as much and not get the speed, precision, flexibility and accuracy offered by our four logically-priced probes—including our remarkable new 150 MHz ECL Probe. Not to mention the versatility, reliability and durability we've become famous for.

But we don't stop there. When it comes to logic testing, Global Specialties does the *complete* job. With our DP-1 auto-sensing digital signal injector—for fast, easy stimulus-response testing, at an economical \$83.00\*. Plus a line of multi-channel Logic Monitors that provide an inside picture of circuit activity at up to 40 nodes simultaneously. And each product has an idea-filled applications manual—as well as an unmatched line of high-functional accessories, to extend its versatility still more.

With Global Specialties, there's no need to compromise on performance. Or *value*. Discover for yourself why we're the number-one logical choice!

True multi-family performance:  
DTL, TTL, CMOS.  
Or ECL!†

Easy-to-use Memory and Pulse functions

Full readout indications—HI, LOW, PULSE

Overload and AC-line-protected high-impedance input  
Linear input impedance eliminates errors due to non-uniform loading

Complete line of interchangeable probe tips and grounding wires, including easy clip, banana plug, alligator clip jumpers and variety of power cords

Interchangeable thin-profile power cords (instead of awkward, heavy or coiled cords)

Unsurpassed reliability—performance proven

All specs conservative and *guaranteed*

Half the price for equal (or better) performance

Circuit-powered with reverse-voltage protection

Compact, high-impact, human-engineered case



**Standard LP-1**, only \$50.00\*, with latching memory—captures pulses as fast as 50 nsec, to 10MHz, guaranteed

**Economy LP-2**, \$32.00\*, guaranteed to 50 nsec, 1.5 MHz

**High-speed LP-3** with memory, only \$77.00\*, guaranteed to 10 nsec (6 nsec, typical) and 50 MHz!

**New ECL LP-4†**, \$150.00\*, the new industry standard—with memory, guaranteed to 4 nsec (2 nsec, typical) at 150 MHz!

†LP-4 probe exclusively for use with ECL. For DTL, TTL or CMOS, select LP-1, -2 or -3.

70 Fulton Terr., New Haven, CT 06509 (203) 624-3103, TWX 710-465-1227  
OTHER OFFICES: San Francisco (415) 648-0611, TWX 910-372-7992  
Europe: Phone Saffron-Walden 0799-21682, TLX 817477  
Canada: Len Finkler Ltd., Downsview, Ontario

**GLOBAL  
SPECIALTIES  
CORPORATION**

Call toll-free for details  
**1-800-243-6077**  
During business hours

\*Suggested U.S. resale. Prices, specifications subject to change without notice. © Copyright 1981 Global Specialties Corporation.

CIRCLE 47 ON FREE INFORMATION CARD

# HOBBY CORNER

## Put that old calculator to good use

EARL "DOC" SAVAGE, K4SDS, HOBBY EDITOR

HOW WOULD YOU LIKE TO OWN, FOR only \$30, a digital capacitance meter that will measure from a few picofarads to the largest value you are likely to encounter? Or, for the same price, a digital ohmmeter with an upper range that you can measure well into the multi-megohms? How about a digital stopwatch/timer, a shutter-speed tester, a tachometer, a light meter, or a speedometer?

Some of those devices sound all but impossible for the price. You probably wouldn't believe it if I told you that you could have all of them for about \$30 total! Well, believe it because it's true. Let's see how you can do it.

First of all, I'm allowing \$10 to buy a basic "four-banger" calculator. Even if you go out and buy a new one, that's more than enough money. When I started looking recently, I found five of the little things scattered around my home. You probably have several, yourself. Further, I saw an ad offering six manufacturers' rejects for one buck.

The only absolute restriction on the type of calculator is that it must have a "constant add" function: that is, each consecutive time the EQUALS key is pressed, the total is increased by one of the earlier entered digits (probably the last one entered).

Also, it is desirable that the calculator have a fast internal clock oscillator. That is more likely to be found in the cheaper models. The faster the clock, the shorter are the intervals between calculations.

Back to the cost, five dollars is allowed for the purchase of a few common capacitors, resistors, and switches. Of course, you'll only need the full \$5 in the unlikely event that you don't even own a junk box.

The final \$15 of your allotment will have to be spent. It is for a nifty little RC-111 module from Kaltek (Box 7462, Rochester, NY 14615). This amazing device measures approx.  $\frac{3}{4} \times \frac{3}{4} \times \frac{3}{8}$  inch, and it makes the whole thing possible. The RC-111, plus a very few additional components will convert your four-banger into any of the instruments listed above plus a few others. Because of the small size and parts count, often everything will fit right into the calculator case.

Of course, you *can* build separate instruments, but with suitable switching or plug-in arrangements, you can have a multi-purpose instrument. And, by the way, whatever you build, the calculator will still have its original functions. Here's how the RC-111 does its magic.

Before I start, though, let me say that the manual that comes with the RC-111 is quite complete. It gives plenty of diagrams and information for building the instruments. If I miss a point in this brief account, you can bet that the manual didn't.

Two of the eight pins on the module are connected to the calculator (or other) battery. It will operate on any voltage from 3- to 15-volts DC, and that range takes in the battery voltage of almost all calculators.

Two of the module pins are connected across the constant add key of the calculator. That is usually the one marked "=", but all you have to do is to punch a little addition problem to determine which it is on yours.

Let's look at a simple circuit application for the RC-111, and then a few variations. Figure 1 is about as simple as they come. It is a timer or stopwatch. As you can see, the  $\pm$  and D/K pins are connected to the calculator battery and key, respectively.

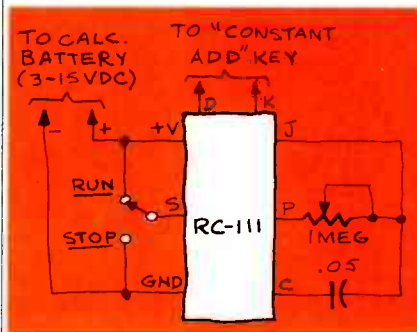

FIG. 1

The capacitor and pot connected to pins J, P, and C are adjusted to give a count rate appropriate to any given use. For the present application, you will want to adjust the rate to an interval of 1, 0.1, or 0.01 second. In fact, you can increase the accuracy to maximum (decrease the interval to minimum) by making the rate just as fast as the cal-

culator will count—that's why the internal clock rate of the calculator can become important.

The switch can be of the push, slide, or toggle variety as you prefer. When pin S is positive, the RC-111 counts; when negative, it stops. All you have to do is enter "1" or "1 + 1", depending upon the calculator model, then operate the switch during the period to be timed. The readout shows units, tenths, or hundredths of seconds. Note that you will have to subtract one from the readout if you use a "1+1" calculator, but most of us can do that in our heads!

A .05 µF polystyrene-type capacitor located at pin C will provide very good accuracy. For the highest accuracy, you can eliminate the capacitor and pot, and feed pulses from a crystal timebase oscillator into pin J.

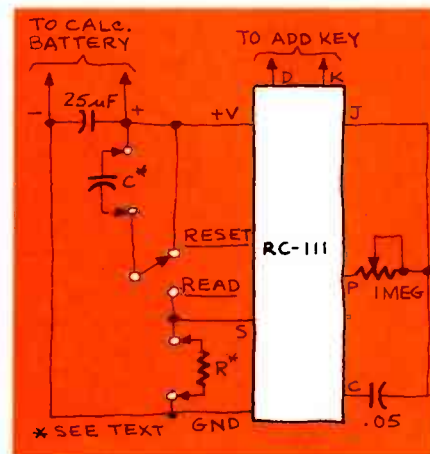

FIG. 2

There you have a neat and simple timer. If you keep in mind the functioning of pin S, the circuit in Fig. 2 is easy to understand. With the switch in the RESET position, pin S is negative and nothing happens. When placed in the READ position, pin S goes positive and the calculator counts until capacitor C charges. At that time, pin S goes low, the counting stops, and the time can be read from the display.

Now, you don't care how many tenths or hundredths of a second it takes a capacitor to charge. What you *do* want to know is the value of the capacitor in micro- or picofarads. That's easy to arrange: Just adjust resistor R, or the

*continued on page 72*



# MARCH SPECIALS

WE CARRY THE COMPLETE LINE OF ATARI SOFTWARE, PERIPHERALS AND ACCESSORIES.

## OKIDATA MICROLINE 80



**\$329.00**

## ATARI 810 DISK DRIVE



**\$429.00**

# PERSONAL COMPUTERS

|   |         |                                      |         |
|---|---------|--------------------------------------|---------|
| CBM 8032 Computer                           | 1149.00 | Epson MX-100 FT                      | 729.00  |
| CBM 8050 Disk Drive                         | 1349.00 | NEC PC-8023 Printer                  | 629.00  |
| CBM 4032 Computer                           | 1029.00 | NEC 7710 Spinwriter                  | 2345.00 |
| CBM 4040 Disk Drive                         | 1029.00 | NEC 7720 Spinwriter                  | 2695.00 |
| CBM 4022                                    | 649.00  | NEC 7730 Spinwriter                  | 2345.00 |
| CBM VIC-20                                  | 269.00  | NEC JC 1201 M(A) — Color 12" Monitor | 359.00  |
| Amdek 100G                                  | 159.00  | NEC 12" JB 1201M Monitor             | 159.00  |
| Amdek Color — 1 13" Color Monitor           | 329.00  | Okidata Microline-80                 | 329.00  |
| Microtek 16K Ramboard for Atari 800         | 79.00   | Okidata Microline-82A                | 499.00  |
| Microtek 32K Ramboard for Atari 400 and 800 | 149.00  | Okidata Microline-83A                | 729.00  |
| Qume Sprint 9/45 (Full Panel)               | 2295.00 | Diablo 630                           | 1995.00 |
| Atari 400 16K                               | 339.00  | M & R Sup-R-Terminal                 | 279.00  |
| Atari 410 Recorder                          | 60.00   | Microsoft Soft Card (Z-80)           | 279.00  |
| Atari 825 Printer                           | 599.00  | Hazeltine 1420                       | 799.00  |
| Atari 850 Interface                         | 139.00  | Northstar Horizon II 32K QD          | 2925.00 |
| Atari 810 Disk Drive                        | 429.00  | Anadex DP-9500/9501                  | 1249.00 |
| Atari 800 16K                               | 749.00  | Televideo 910                        | 559.00  |
| Epson MX-70                                 | 349.00  | Televideo 912C                       | 669.00  |
| Epson MX-80                                 | 449.00  | Televideo 920C                       | 689.00  |
| Epson MX-80 FT                              | 549.00  | Televideo 950                        | 929.00  |



**NEC GREEN  
12" MONITOR JB 1201M  
\$159.00**

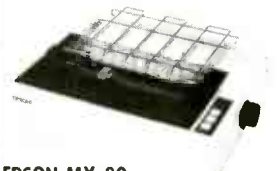

**EPSON MX-80  
INTERFACE & CABLES IEEE \$55.  
RS-232 \$70 TRS-80 CABLE \$35.  
\$449.00**



**AMDEK COLOR-1 MONITOR  
\$329.00**



**EPSON MX-100 FT PRINTER  
\$729.00**

## CALL TOLL FREE!

### EAST COAST

**1-800-556-7586**

COMPUTER SHOPPING CENTER

12 Meeting Street  
Cumberland, RI 02864  
1-401-722-1027  
TELEX 952106

### WEST COAST

**1-800-235-3581**

COMPUTER SHOPPING CENTER

3533 Old Conejo Rd. #102  
Newbury Park, CA 91320  
1-805-499-3678  
CA. TOLL FREE 1-800-322-1873  
TELEX 182889

# COMPUTER SHOPPING CENTER

We Accept C.O.D.'s • Stock Shipments Same Day or Next • No Surcharge for Credit Cards  
• All Equipment Factory Fresh w/MFT Warranty • We Carry the Complete Line of Personal Software  
• Prices do not Reflect Shipping Charges  
Rhode Island and California Residents please add 6% Sales Tax

**PRICES ARE SUBJECT  
TO CHANGE  
WITHOUT NOTICE**



# THE ROI\* FACTOR

(\* Return On Investment)

## A small investment can upgrade the sound of your entire hi-fi system.

If you're one of the millions who have bought a Shure V15 Type III, M97 Series, M95 Series, or M75 Series phono cartridge, we have a way of making it perform *better* than it ever has before. It's the Shure Hyperelliptical (HE) upgrade stylus (needle) series. We've taken all the high trackability/low distortion benefits of the HE stylus tip (first introduced on the famous V15 Type IV), and put them into styli that will match perfectly with your cartridge, for an audible improvement in your system's sound at an absolutely minimal cost to you!

Upgrading your phono cartridge with an HE replacement stylus will give a large return on a very small investment. You already own a phono cartridge with proven performance; now you can get even better performance from that same cartridge. Ask your dealer for the Shure HE replacement stylus that's right for you, and take advantage of the ROI factor.



Shure Brothers Inc., 222 Hartrey Ave., Evanston, IL 60204  
In Canada: A. C. Simmonds & Sons Limited  
Manufacturer of high fidelity components, microphones, speakers, sound systems and related circuitry.

### HOBBY CORNER

continued from page 70

capacitor connected to pin C, or the pot connected to pin P, so the calculator counts in microfarads or picofarads! Of course, you do that by using a known capacitor for C to calibrate your capacitance meter.

You are probably way ahead of me—yes, the circuit in Fig. 2 is also an ohmmeter. Using a known capacitor C, the readout can be calibrated in the same manner as before to show the value of resistor R. The reading can be in ohms, kilohms, or megohms, depending upon your calibration scale.

Now you are well on your way. By controlling the module rate and the on-time with the polarity of pin S, you can measure all kinds of things. As you see, there is no problem in adjusting the module rate to your needs.

Pin S can be "switched" from minus to plus in a variety of ways. Two are shown in the examples above. Of course, a transistor switch can be used. Another way is with a magnetically operated reed switch. Then, too, the common photocell and the photo-transistor can be used to change the potential on pin S.

By using different switching methods on pin S, and having the actual switching controlled by various actions, you can have any of the instruments mentioned earlier. For example, you can see that a magnet on a bike wheel activating a reed switch will count the rotations of the wheel and you can calibrate that into miles-per-hour, feet-per-minute, or whatever strikes your fancy. Several of those applications are illustrated in the *RC-111* manual.

It should be obvious to you at this point that an old calculator and an *RC-111* module can team up to do a variety of jobs. If you come up with any unusual applications, I would be glad to hear of them.

R-E

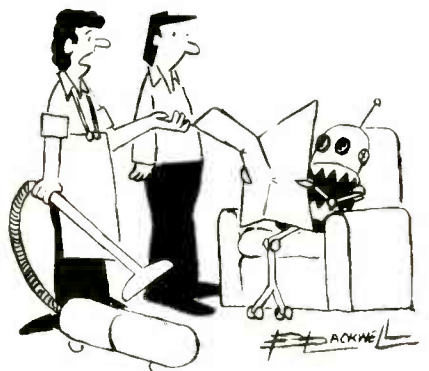

"I originally built the robot to do simple tasks. Then I added to it, making it more and more sophisticated, until finally..."



## CALL NOW AND RESERVE YOUR SPACE

- \$550 for a 6X frequency insertion.
- Reaches 211,387 readers.
- Fast reader service cycle.
- Short lead time for the placement of ads.
- We typeset and layout the ad at no additional charge.

Call 212-777-6400 to reserve space. Ask for Arline Fishman. Limited number of pages available. Mail materials to: mini-ADS, RADIO-ELECTRONICS, 200 Park Ave. South, New York, NY 10003.

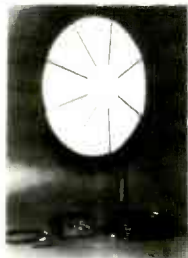

**AMATEUR MICROWAVE RECEIVER SYSTEM** (pictured) provides wide-band, high gain reception of amateur television transmissions from 2.1 GHz to 2.6 GHz. View on your television. Order MA1: **\$169.95**. **MICROWAVE TELEVISION EDUCATION MANUAL** includes detailed microwave downconverter, power-supply, and antenna plans: **\$16.25**. **SUBSCRIPTION TELEVISION EDUCATION MANUAL: \$14.95**. Add 5% shipping and handling. *Informative catalog: \$2.00*. **ABEX, P.O. Box 26601-RE, San Francisco, CA 94126-6601.**  
CIRCLE 71 ON FREE INFORMATION CARD

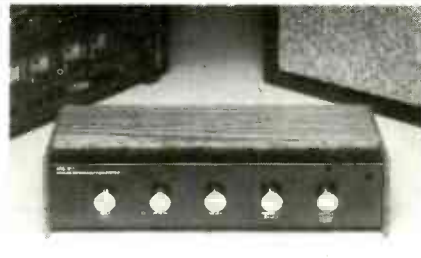

This **DYNAMIC NOISE REDUCTION SYSTEM** is a significantly improved version of the NR-2 (featured in R.E. Aug./Sept. 79) employing the most advanced IC's to reduce the noise in your stereo system by up to 14dB. Works with all program sources (including Dolby® tapes) to make your sounds virtually noise free. **AAS-450, \$189.00**, VISA, M/C welcome. **Advanced Analog Systems Inc., 790 Lucerne Dr., Sunnyvale, CA 94086, (408) 730-9786.** Dolby® is T.M. of Dolby Licensing, S.F. CA  
CIRCLE 78 ON FREE INFORMATION CARD



**AUDIO DELAY LINE**, Make your listening room sound like a concert hall. The **ARS-911** adds the effect of spatial dimension to your sounds; that big real life feeling. Featured in R.E. (Sept./Oct. 81) **ARS-911 Kit only \$149.95**. VISA, M/C welcome.—**Advanced Analog Systems Inc., 790 Lucerne Dr., Sunnyvale, CA 94086, (408) 730-9786.**  
CIRCLE 77 ON FREE INFORMATION CARD

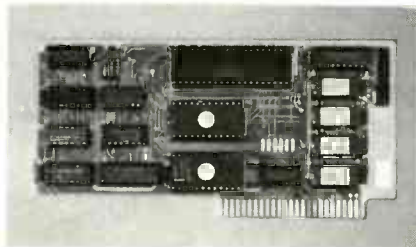

The **Microbuffer II** is an intelligent buffered parallel printer interface for the Apple II computer. Includes 16K of on-board RAM. Buffer memory size is user expandable to 32K. Compatible with Applesoft, CP/M, and Pascal. Includes advanced high resolution graphics print routines for the Epson MX-80 with Graphtrax, Anadex, IDS Paper Tiger, NEC Prowriter. Price: **\$259**. **Contact Practical Peripherals, Inc., 31245 La Baya Dr., Westlake Village, Calif. 91362 (213) 706-0339.**  
CIRCLE 73 ON FREE INFORMATION CARD



**UNGAR'S NEW LIGHTWEIGHT DESOLDERING PUMP**, Economical, easy-to-use, one hand operation. **Pump Number 7874** features easy-set plunger with built-in safety shield, press release switch, no-clog automatic tip cleaner and replaceable Teflon® Tip #7875. Pump is ¾" D. x 8½" L., made of aluminum with durable anodized finish. **Suggested Resale: \$14.95 each**. Available through your Ungar Distributor or contact...**UNGAR, Division of Eldon Industries, Inc., P.O. Box 6005, Compton, CA 90220, (213) 774-5950, (800) 421-1538.**  
CIRCLE 75 ON FREE INFORMATION CARD



**1.2 GHz FREQUENCY COUNTER** with 0.1 PPM high accuracy, 0.001 Hz resolution, and 10 MHz proportional oven for—**\$299.95**. **DigiMax Instruments** presents a full line of frequency counters featuring accuracy, performance, and low prices, starting from **\$149.95**. For more information contact: **DigiMax Instruments Corporation, 5625 Kearny Villa Rd., San Diego, CA. 92123, (714) 569-6582**. Toll Free (outside CA.) (800) 854-1566, Telex-697120-DATA-MAX.  
CIRCLE 74 ON FREE INFORMATION CARD

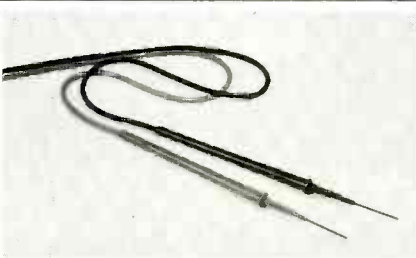

**AT LAST! COMPLETELY REPAIRABLE TEST PROBES. MICROPROBES** from Huntron Instruments feature a needle-sharp stainless steel point on a telescoping, length adjustable electrode insulated to withstand 1KV right down to the ground tip. Super-Slim valox probe bodies and 5 foot superflex leads. **All parts are replaceable! \$9.95 + \$3.50 handling.** Add CALIF. or WASH. tax. **Visa/Mastercharge accepted.** **Huntron Instruments, 15123 Hwy. 99 North-Lynnwood, WA 98037 (800) 426-9265.**  
CIRCLE 72 ON FREE INFORMATION CARD

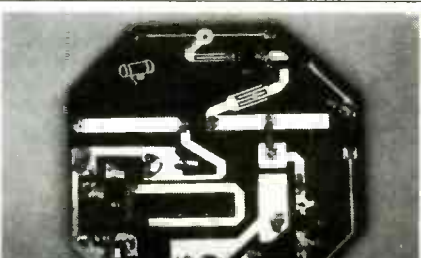

**2300 MHz DOWNCONVERTER kit** for Amateur microwave reception. **\$35.00 postpaid**. Highest quality components. Send SASE for information filled catalog of other converter kits, preamps, accessories and parts. VISA and MASTERCARD accepted.  
**SMP - Superior Microwave Products, Inc. PO Box 1241 Vienna, VA 22180 1-800-368-3028 1-703-255-2918**  
CIRCLE 76 ON FREE INFORMATION CARD

# COMMUNICATIONS CORNER

## Speech-scrambling techniques

HERB FRIEDMAN, COMMUNICATIONS EDITOR

ONE OF THE REAL THRILLS OF SHORT-wave listening is hearing the news before it's seen on TV or the headlines of the major newspapers (whatever "major" is supposed to imply). I can remember using a surplus BC-348 receiver to "read the mail" on the overseas phone circuits and government transmitters, and "astounding" my friends and family when I told them of some new war or scandal that hadn't yet made the local papers or the "on-the-hour" newscast of the local radio stations. Today, it's somewhat more difficult to get the facts first-hand because much of what you'd like to know about is sent by radio teletype—called RTTY—or scrambled radio telephone, but it is still possible to monitor many of those transmissions.

To monitor RTTY you need to know the operating times and frequencies of the various transmissions; and if you don't want to spend most of your time fiddling with the dials, you also need to know the station's baud rate (speed of transmission) and shift frequency. I could take up this whole issue of **Radio-Electronics** and still not give you enough information to get any enjoyment out of RTTY.

A better introduction to RTTY is an excellent handbook that I recently received in the mail: *World Press Services Frequencies*. That little gem is not only a handbook on how RTTY works, and the equipment that you'll need to receive it; it also lists the frequencies, times, baud rates, shift frequencies, etc. of the commercial press services such as UPI, XINHUA (China), Reuters, Tass (Russia), and so forth. It's a thorough job and the work was obviously a time consuming labor of love by the author, Thomas Harrington, W8OMV.

Just keep in mind that while there's no law to stop you from reading the mail, you cannot divulge anything you hear to another party. The book is priced at \$5.95 and is published by Universal Electronics, Inc.; they are located at 1280 Aida Drive, Reynoldsburg, OH 43068.

### Scrambled communications

Not all scrambled communications systems use sophisticated computer circuits, and many of the ones that don't can be easily monitored. That is particularly true of some of the systems that are commonly used on the UHF

frequencies.

Among the earliest, and still effective means of scrambling communications so that the "average" SWL (ShortWave Listener) cannot monitor them is speech inversion. That system makes a transmitted signal sound like the "Donald Duck" chatter of SSB. In speech inversion, all that is done is to mix the voice frequencies and a steady carrier in a ring modulator.

To get a better idea of how speech inversion works, let's look at a simplified example. Assume that the voice frequencies are 300-2500 Hz, and that the carrier is 3000 Hz, as shown in Fig. 1-a. When the voice signal and the carrier are mixed in a ring modulator, what comes out is the sum and difference frequencies. (A ring modulator is a balanced modulator. A four-quadrant multiplier IC can be used as a ring modulator.) When the sum is removed, you are left with the difference, which is an exact inversion of the original speech frequencies. When the speech is inverted, 300 Hz becomes 2700 Hz, and 2500 Hz becomes 500 Hz, as shown in Fig. 1-b. Anyone monitoring a signal that has been inverted in that manner will hear "garbage."

At the receiver, the scrambled signal is decoded by once again mixing the signal with a carrier in a ring modulator. That will re-invert the signal. If the carrier is 3000 Hz as before, the original 300-2500-Hz input signal is recovered, as shown in Fig. 2. One problem with that scrambling system is that if someone assumes that the transmission is SSB and adjusts the BFO to "tune in" the signal, he may be able to decode the scrambling since one BFO setting will re-invert the signal in exactly the same manner as is done by the descrambler or decoder.

Several years ago, before the "age of the microprocessor," I experimented with an "unbreakable" scrambler. (At least, I thought it was unbreakable at the time.) In those experiments, I used a signal from a national radio network as the "carrier." The "receiving" station—rather than broadcasting the signal, a telephone hook-up was used—picked up the same signal from a local radio station and used it for decoding a transmission.

Fortunately, I knew little about

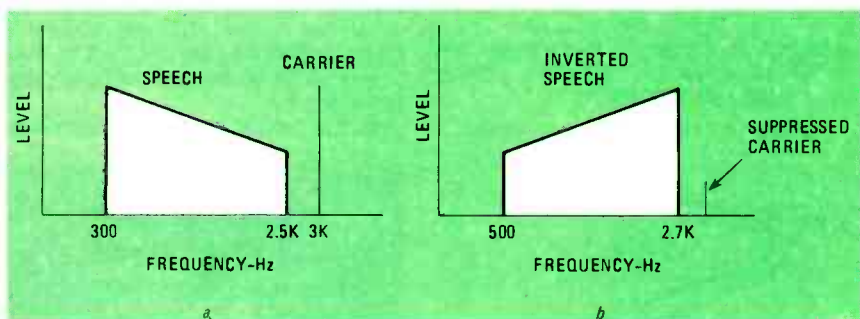

FIG. 1

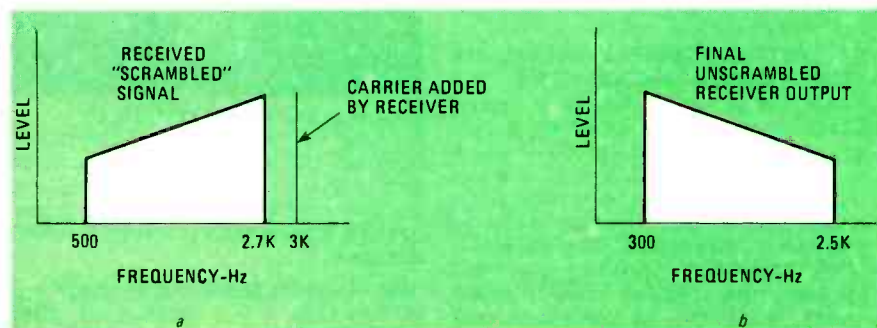

FIG. 2



scrambling at the time (which isn't all that much more than I know now) so I did not know that there were at least ten good reasons why the idea should not work. Of course the darned thing worked! The sound was somewhat garbled, but a message using some non-technical, simply constructed phrases could be understood. Had I known more about filters, and had the time to work on the thing, it probably would have proved commercially viable. But I was doing my experimentation just for fun, and once satisfied that my idea would more or less work, packed everything into a box and simply forgot about it.

Today, much scrambling is done using a microprocessor. Instead of the steady tone of a carrier, or the radio-station signal of my "Friedman Special," a constantly changing sampling rate is used to digitize a speech signal. The digital transmission also serves to program the microprocessor at the receiving station to decode the signal. When total security is required, the digitized transmission only serves to synchronize the microprocessor at the receiver. Since no key to the sampling sequence is transmitted, the scrambling is almost unbreakable. (I say "almost" because in electronics nothing is any better than "almost." By the time you read this, someone may very well be selling a 50-cent IC that is capable of "breaking" all of the digital scramblers currently in use.)

Though the digital scramblers are essentially unbreakable, many scrambler users make things simple, to keep overall costs down and receiving problems at a minimum. They are not as interested in absolute security as in making their copy unintelligible to the general public. After all, anyone that really wants to break a scrambler code can probably do so.

One major problem for the SWL is that HF-circuit scramblers are usually used with SSB. That means that you need a second local oscillator, because the receiver's regular BFO is being used to receive the SSB signal. You can either mix the received audio in a ring modulator with a variable-frequency/variable-level audio oscillator, or radiate a small tunable "IF frequency" into the antenna input, as was done in the early days of CB SSB. The whole thing is a lot of fun to try, although it is rather time-consuming when you're trying to establish the best "carrier" level in the descrambler.

If any of you give it a try, please drop me a line, in care of **Radio-Electronics**, and let me know how you make out. Perhaps some other readers will be interested in your results; we'll run the highlights of your experiments in future issues.

R-E

# SOLID STATE IMAGER ACTUAL SIZE:

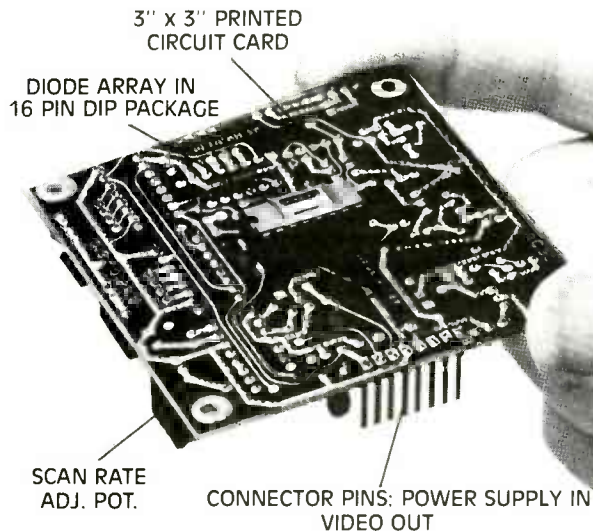

## ACTUAL PRICE: \$98 or \$125

You can now afford to evaluate optical scanning techniques for your system application. For just \$98/\$125 RETICON offers the RL128G/RL256G self-scanning photodiode array with 128/256 diodes on 25 $\mu$ m (1 mil) centers and a complete interface circuit (model RC301) which allows the diode array to be operated over a wide range of scan rates and integration times to fit many system requirements. Just connect your standard power supply and get a wide dynamic range video signal out.

Applications include OCR, pattern recognition, noncontact size and position measurement, inspection for defects, spectrometer readouts and many more.

For higher resolution requirements, other RETICON self-scanning photodiode arrays are available with up to 4096 diodes in a linear configuration and 256x256 diodes in a matrix configuration.

This special offer valid only in the U.S. and Canada until May 31, 1982. Don't delay-evaluate this exciting new technology today! For information call: (408) 738-4266 or Boston (617) 745-7400, Chicago (312) 640-7713, Los Angeles (714) 895-3367.

Please mail in this coupon or attach to your purchase order.  
Mail to: **EG&G Reticon**, 345 Potrero Avenue, Sunnyvale, CA 94086

I enclose \$\_\_\_\_\_ for (include sales tax in CA, IL, MA and MD):

- \$98 RC301 circuit card with 128 element array.  
 \$125 RC 301 circuit card with 256 element array.

Name \_\_\_\_\_

Address \_\_\_\_\_

City \_\_\_\_\_ State \_\_\_\_\_ Zip \_\_\_\_\_

Yes, I would be interested in a 32 x 32 Matrix Array. My application is:

RE

CIRCLE 52 ON FREE INFORMATION CARD

MARCH 1982

75

# COMPUTER CORNER

Games (computer) people play.

LES SPINDLE\*

DESPITE THE OFTEN-HEARD PHRASE "personal computer," microcomputers today are largely used as serious devices for practical business applications; the "computer-in-every-home" era still seems to be a considerable time away. To fuel the fires of home-computer sales, manufacturers and vendors try to impress upon consumers the image of the home computer as a practical device; but the largest percentage of software purchased by home users falls into the same category that predominated five years ago—fun and entertainment applications.

That should come as no surprise. The widespread use of some of the most sophisticated electronic developments of the last hundred years—television, radio, and the telephone—can still be attributed at least as much to their capabilities for providing amusement as to their use for communications.

Because of that, the computer-game industry is a booming business, with millions of dollars worth of game cassettes and disks being sold annually. Hundreds of software companies, large and small, release new offerings every month. Some examples of game software are shown in Fig. 1.

## Electronic-game history

The computer-game scramble began in 1966, when Ralph Baer sold the rights to his video-game invention, *Odyssey*, to Magnavox. The game reached the market in 1972, and the phenomenon was on its way.

The early games were simple, ping-pong-type diversions with little challenge or variety. The next phase offered more options for players by using switches to select various modes of operation. In 1977, with Fairchild's *Video Entertainment Center*, programmability was added.

Most modern games are sophisticated and challenging, because they offer the possibility for the player not only to alter the existing games, but also to devise new ones. That's made possible by a microprocessor in each game console, and by the availability of ROM (Read-Only Memory) cartridges containing the game elements.

All the games discussed so far have

been "dedicated" devices—all they can do is play games. The next step is a microcomputer system that permits you to expand your game-playing horizons beyond the limitations imposed by the dedicated game-machines. You can write your own games if you wish, and save the game results on cassette to determine your errors, or continue a game that had been started previously. And—perhaps the most important thing—after you've had your fill of game-playing, you can turn the computer to more practical applications.

Some manufacturers are turning out game consoles that are actually complete microcomputer systems, complete with keyboards and memory. The *Interact*, from Microelectronic Systems Corp., for instance, uses an 8080 microprocessor and offers some software in addition to games, including home and business applications-programs.

One popular computer that is especially suited for game-playing is the *Apple II*. While its capabilities extend far beyond that, it offers superb game-potential for the computer enthusiast who appreciates the computer's entertainment value as well as its practical side. With a keyboard, game paddles,

excellent graphics capabilities, and a sound generator, the computer is the ideal choice for creating games and playing those created by others. Needless to say, there is a wealth of game software available for the *Apple*.

## Game types

What kind of games can you expect to find for computers? There is a wide variety available, but a few popular formats tend to dominate the market. If you consider television to be a "sitcom factory" where one hit series spawns dozens of spinoffs, ripoffs, and imitations, you haven't seen anything until you've played the hundred-and-first version of a *Space Invaders* or *Star Trek* computer game. That doesn't seem to bother buyers, though; the formats that sell are the familiar ones.

At the simplest level, board-type games continue to be popular. Games such as tic-tac-toe, checkers, chess, and backgammon, hardly make extensive use of color graphics or other dazzling effects, but are formidable brain-teasers and entertain players for hours at a stretch. Several computer-chess competitions are held by computer clubs and other organizations

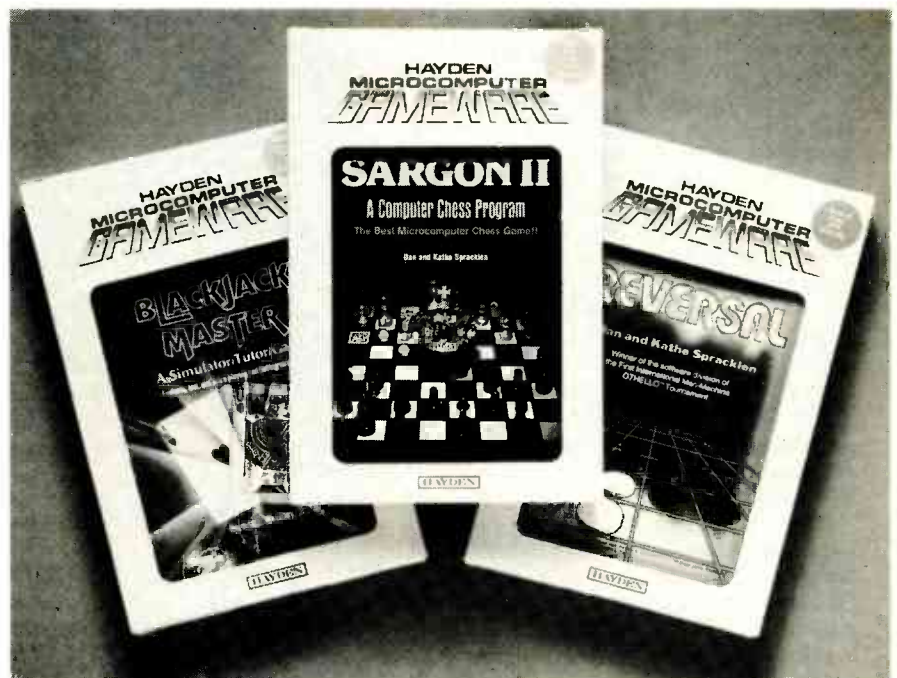

FIG. 1

\*Managing Editor, *Interface Age* magazine



here and in other parts of the world.

Guessing games provide some intellectual stimulation and, in some cases, are educational. Arithmetic calculations and problems in logic expand the programs into truly stimulating exercises. For example, one game challenges the player to search a grid of dots to locate a hidden object. Clues and hints are provided along the way to bring the astute player, step-by-step, closer to solving the puzzle.

Casino games satisfy the gambling instinct in computer buffs, creating exciting situations with poker, roulette, and blackjack competitions. While you can't win any money, you can't lose it, either.

### Simulations

Computers are widely used to perform simulations—programs that mimic real-life events, and whose outcome can be changed by changing the values of the data used.

Simulations are used in business to make long-range financial decisions by posing hypothetical situations to the computer. The armed forces frequently make use of computer simulations, and medical schools often depend on simulations for training purposes—electrons are more expendable than lives.

Simulations are also widely used in games. The Star Trek games cast the player as captain of the starship *Enterprise*; the object is to seek out and destroy Klingon battle cruisers without being destroyed yourself.

Another popular simulation is Adventure, a game in which you explore a vast, complex, underground world filled with treasures, magic, and menaces. The game is highly addictive and, when you've exhausted one version of Adventure—if that's possible—there are many more waiting.

Still another simulation puts you in the position of an air-traffic controller, guiding over 20 planes into, out of, and around your airport.

Home-computer versions of popular arcade games are also available. There are Space Invaders games to run on almost any machine. Missile Command and Pac-Man are two other games that have been adapted for microcomputers.

How do you select the best version of a game? Ask the man who plays one. Frequent your local computer club, follow the software reviews in computer magazines, and ask fellow computer owners whether you can try their games before investing in your own. You'll find the world of computer hobbyists—game enthusiasts, in particular—to be a friendly and cooperative brotherhood.

There's a saying: "You can tell the man from the boy by the price of his toy." Whoever coined that phrase must have been a computer buff. R-E

# Compare the best.



We'd like you to compare Keithley's new Model 179A general purpose bench TRMS multimeter to its closest competitor.

|              | 4 1/2-digit resolution | 5 full functions | 10µV sensitivity | TRMS | DCV accuracy | Field installable battery pack | Input protection on Ω | Size of digits | Display | HI-LO Ω | IEEE-488 option | PRICE: |    |       |
|--------------|------------------------|------------------|------------------|------|--------------|--------------------------------|-----------------------|----------------|---------|---------|-----------------|--------|----|-------|
| <b>179A</b>  | ✓                      | ✓                | ✓                | ✓    | 0.04%        | ✓                              | 1000V                 | NO             | .56"    | LED     | ✓               | ✓      | ✓  | \$359 |
| <b>8050A</b> | ✓                      | ✓                | ✓                | ✓    | 0.03%        | NO                             | 500V                  | ✓              | .50"    | LCD     | NO              | NO     | NO | \$369 |

Dollar for dollar, feature for useful feature, we think our new 179A gives you more common sense utility for your money. What do you think?

- I'd like a closer look at the 179A. Please call me to arrange a demo.
- Please send the new Keithley handheld, portable and bench meter catalog including the complete 179A specs.
- I'm interested in other Keithley products.
- High resolution and Systems DMMs.
- Keithley Scientific Instruments.

Name \_\_\_\_\_ Title \_\_\_\_\_

Company \_\_\_\_\_ Phone \_\_\_\_\_

Address \_\_\_\_\_

City \_\_\_\_\_ State \_\_\_\_\_ Zip \_\_\_\_\_

MAIL TO:

## KEITHLEY

Keithley Instruments, Inc.  
28775 Aurora Road/Cleveland, Ohio 44139-9990/(216) 248-0400

# STATE OF SOLID STATE

## Play a tune with these new IC's

ROBERT F. SCOTT, SEMICONDUCTOR EDITOR

HARDLY A DAY PASSES THAT I DON'T read about some interesting new or improved semiconductor device, or of an innovative application for a more familiar one. But all too often, some of the most exciting devices are available only to equipment manufacturers, or are priced beyond the range of the average hobbyist.

That is not the case with a series of IC's available from Epson America. It has released a series of 24 melody-generator CMOS LSI devices. They are programmed to play selected melodies and to produce chime and alarm tones. They can be used in musical toys, to replace doorbells and chimes, as replacements for the mechanical devices

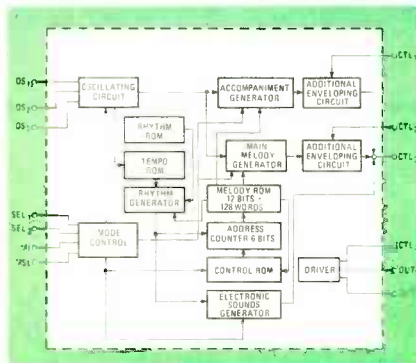

FIG. 1

in music boxes, and to produce musical tones that are a pleasant change from the strident clanging of a gong or the rasping sounds of a buzzer used in many applications. The devices are nearly complete in themselves, requiring only a speaker, 1.5-volt battery, and a few external parts for operation.

The 7910 series of IC's provides a selection of two preprogrammed tunes plus a chime and an alarm tone. The melody arrangements are diphonic—two notes sound at once. The 7930 series of IC's play only a single tune. The 7920's are simple 8-pin DIP devices, made by omitting the audio preamp/

driver from the 7930.

Figure 1 is a block diagram of a 7910 and Fig. 2 is a circuit that can be used to drive the IC. The built-in oscillator—two series-connected inverters connected between pins 1, 2, and 3 (terminals OS<sub>1</sub>, OS<sub>2</sub> and OS<sub>3</sub>) and tuned by R<sub>01</sub>, R<sub>02</sub>, and C<sub>0</sub>—generates a nominal frequency of 47.5 kHz. That signal is processed by the various internal circuits to develop the notes, tempo, keying, shaping, and other controls needed to produce a specific melody, chime, or alarm.

Pin 4 (terminal MI) is the on-off control point. The tune starts at the beginning of the melody when that terminal is switched HIGH (connected to V<sub>DD</sub>) and continues until the circuit to terminal MI is opened (switched to LOW). If the terminal is still switched HIGH when the tune ends, the tune is simply played over.

Control terminals CTL<sub>1</sub> and CTL<sub>2</sub> (pins 10 and 11), when connected to R1-C1 and R2-C2, regulate the time constant of the envelope. The overall tone can be changed by varying C1, C2, R1, and R2. Terminal CTL<sub>3</sub> (pin 12) is the unamplified output of the melody-generator section of the IC. Terminal CTL<sub>4</sub> (pin 13) is the input to the built-in audio preamplifier. In Fig. 2, R4 is the volume control. Terminals OUT<sub>1</sub> and OUT<sub>2</sub> (pins 14 and 15) are the preamp outputs used to drive the complementary bipolar output-transistors.

Terminals SEL<sub>1</sub>, SEL<sub>2</sub>, and MSL (pins 5, 6, and 9) are used to control the output of the IC. The terminals are connected to switches (S1-S3) that are used to select melodies, chimes, or alarm, depending on their setting. Table 1 shows

TABLE 1

| FUNCTION            | S1 | S2  | S3  | S4 |
|---------------------|----|-----|-----|----|
| Melody 1            | on | off | off | on |
| Melody 2            | on | off | off | on |
| Buzzer              | —  | on  | off | on |
| Chime               | —  | off | on  | on |
| Test mode/melody 1  | on | on  | on  | on |
| Test model/melody 2 | on | on  | on  | on |

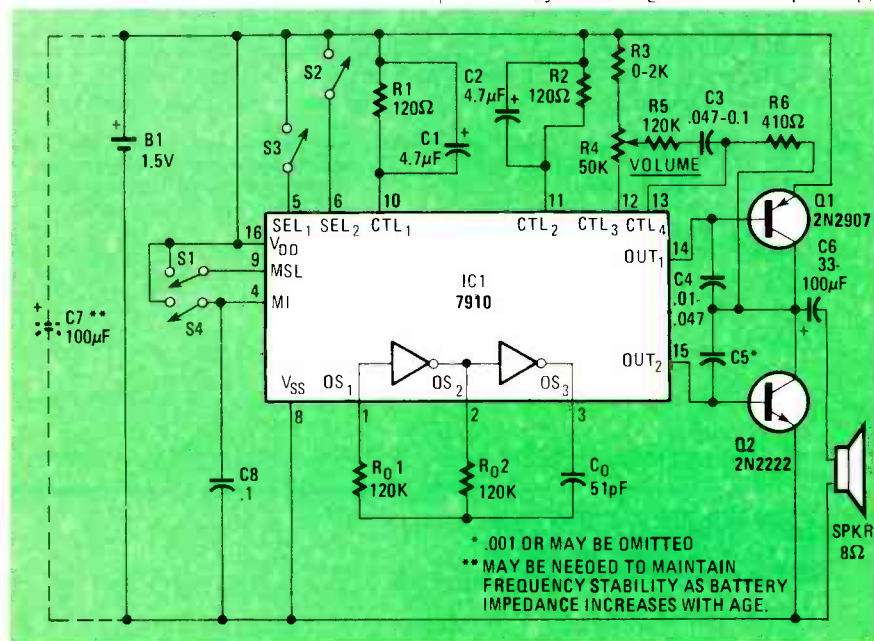

FIG. 2

\* .001 OR MAY BE OMITTED  
 \*\* MAY BE NEEDED TO MAINTAIN FREQUENCY STABILITY AS BATTERY IMPEDANCE INCREASES WITH AGE.



the switch settings for a 7910 programmed for two melodies and two alarm sounds. In the MELODY TEST modes, the tempo of the selected melody is stepped up eight times. The switch settings for 7910's that have two melodies and no alarm, or no melodies and two alarm sounds, are similar to those in the table.

I've mentioned the possibility of using a melody generator as a replacement for a doorbell. For that application, I suggest the 7910-O, P, X, or CH versions. Those are different 16-note arrangements of Westminster chimes; the devices are suitable for use as doorbells since they are programmed to play through just once and then stop.

At present, there are fifteen different IC's in the 7910 series, seven in the 7930 series, and two in the 7920 series. The melodies available are too numerous to list here, but, to give you some idea of what is available, they range from "Jingle Bells" and "Silent Night" in the 7910-CU to a Chopin nocturne and a Mozart minuet in the 7910-CE.

Sample quantities (1 to 9) of the 7910, 7930, and 7920 cost \$10, \$8, and \$7 each, respectively. Circuit boards are available and cost \$15 for the 7910; boards for the 7930 and 7920 cost \$10. If you order the IC and circuit board together (\$25 for the 7910, \$18 for the 7930 and 7920), you get an evaluation kit that includes all parts; all you have to add are an 8-ohm speaker and a 1.5-volt AA cell. To order any of those items, write to Epson America, 3415 Kashiwa St., Torrance, CA 90505. When ordering, include \$1 for shipping and handling. (California and New York residents, add appropriate sales tax.) Incidentally, tune lists and data sheets for the IC's are also available.

R-E



"Now if you're into satellite TV, this is the house for you!"

# Heart disease and stroke will cause half of all deaths this year.

Give the gift of love.



American Heart Association

WE'RE FIGHTING FOR YOUR LIFE

ADVANCE IS PROUD TO INTRODUCE  
Non-Linear Systems

High Quality Oscilloscopes  
Backed by  
A Two-Year Warranty

\*Exception: model MS-230 is slightly deeper, at 8.6", and heavier, at 3.6 lbs.

| MODEL  | VERTICAL BANDWIDTH | DEFLECTION FACTOR             | TIME BASE                              |
|--------|--------------------|-------------------------------|--|
| MS-230 | 30MHz              | 10mV to 50V/div<br>12 Ranges  | 0.05µ Sec to 0.2 Sec/div.<br>21 Ranges |
| MS-215 | 15MHz              | 10mV to 50V/div.<br>12 Ranges | 0.1µ Sec to 0.5 Sec.<br>21 Ranges      |
| MS-15  | 15MHz              | 10mV to 50V/div.<br>12 Ranges | 0.1µ Sec to 0.5 Sec.<br>21 Ranges      |

MS 230



MS 215



Non-Linear Systems' trio of mini-oscilloscopes are accurate, affordable, portable. And there's one to match nearly every budget and need. Standard features on all models include an input impedance of 1 megohm with 50 pF; maximum input voltage of 350 V; trigger modes in auto, internal, external and line; slope that's + or - selectable; graticule (4x5 division of 0.25" each); dual power sources operating either internally from rechargeable lead acid batteries or externally from 115 VAC or 230 VAC (50-60 Hz) via plug-in transformer; handy size (2.9"H x 6.4"W x 8.0"D) and weighs just 3 lbs.\*

Check the chart below for details of model features and specifications.

MS 15

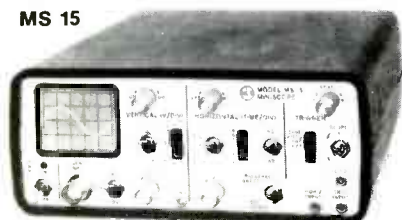

The remarkable Touch Test 20 DMM. With the Touch Test 20 Non-Linear Systems introduces the 2 lb. 4 oz. test lab. Now, with 20 key test functions at your fingertips (plus the ability to measure 10 electrical parameters and 44 ranges), you can take one lab to the field instead of a cumbersome collection of individual testers.

The new Touch Test 20 DMM features:

- Built in temperature measurement (including probe; °F and °C)
- Capacitance measurement
- DC Voltage (200 mV - 1000V)
- AC Voltage (200 mV - 1000V)
- DC Current (200 µA - 10A)
- AC current (200 µA - 10A)
- Resistance (200 Ω - 20MΩ)
- Diode Test

ADVANCE ELECTRONICS

THE TEST EQUIPMENT SPECIALISTS

TOLL FREE HOT LINE  
800-223-0474



54 WEST 45th STREET,

NEW YORK, N.Y. 10036 212-687-2224



Call For Special Introductory Price Offer

# SERVICE CLINIC

## Vertical-retrace-line problems

JACK DARR, SERVICE EDITOR

OVER THE YEARS I'VE RECEIVED A LOT of letters concerning vertical-retrace-line problems. That used to be one of the most "popular" complaints. The problem is easy to identify—there are four or five bright lines at the top of the screen, and they always start at the upper right corner and slant down toward the left. In the early 1950's, TV sets suffered a lot from that complaint, and it was frequently said that the sets came with built-in retrace lines. I've had quite a few letters about the problem recently, and the last one said, "Why don't you write a 'Service Clinic' column about it?" Always happy to receive inspiration, I accepted, and here it is.

Vertical blanking is simple. You feed a vertical-frequency pulse into one of the video circuits, or directly to the picture tube (see Fig. 1). That pulse must be exactly as long as the vertical-blanking interval, and with enough amplitude, and the right polarity, to cause the electron beam in the picture tube to be cut off.

Naturally, the pulse must be present during the vertical-blanking interval (which is the black horizontal bar between frames, as if you didn't know!)

A lot of different vertical-blanking circuits have been used. Early sets fed positive-going pulses to the cathode of the picture tube, or negative-going pulses to the grid. The important thing is

that the polarity of the pulse has to be in the direction of cutoff, and the amplitude high enough to cause full cutoff. One oddball circuit I remember fed rather-high-voltage negative pulses to the picture tube's screen grid! That was on a black-and-white tube set, of course. If you're restoring antiques, watch for it; usually pulses were fed in through capacitors, with shunt resistors. Check for leaky or open capacitors, or resistors whose values have drifted.

Later-model sets, especially solid-state ones, feed blanking pulses into one of the early video-amplifier stages. Very often the first video-stage is used. Popular circuits feed vertical-blanking pulses either into the base or emitter of that transistor. For NPN transistors, the pulse applied to the base is negative-going (reverse biased) while a pulse to the emitter is positive-going. The pulses are often fed through series or shunt diodes; more about them later.

The actual vertical-blanking pulses can be picked off the vertical oscillator-output circuit at quite a few points. What's needed is a point that has a pulse of the proper polarity and amplitude. Sometimes the pulse is shaped by R-C networks. One of the older sets even took the pulse from the vertical yoke! Some solid-state sets use a vertical-blanking amplifier-transistor, for a higher-amplitude pulse, wave-shaping etc. You can find the pickoff point by

looking for a line that isn't used in the vertical circuitry, but goes out and away, usually toward the top of the schematic.

### Other trouble sources

There are a few other things—not in the vertical circuits—that can cause retrace lines to show up. In older sets, if the brightness or contrast is too high, you may see retrace lines. That can be fixed by readjusting the controls. Also, if the AGC is set too far toward "white-out," that can cause the lines to appear. Reset the AGC control and see if that helps.

In the cases just mentioned, the lines show up because the picture tube is simply being driven too hard for the normal blanking-pulse to cause it to be cut off. In recent sets, automatic brightness-limiter circuits have contributed a lot to curing the problem. But they can also be the cause of the lines: If you see retrace lines in a set with an ABL, make sure that the circuit's working.

Check the schematic to see if a vertical-blanking amplifier-transistor is used. If so, and you see retrace lines, use a scope on that stage to make sure it is working. An open transistor could be the source of your trouble. If the transistor is leaky, it can do strange things to the blanking pulse—make it wider, distort its shape, etc., which causes really odd symptoms on the screen.

### Blanking diodes

Here's some more about the blanking diodes. Any defect in them causes problems. If a series diode is open, you'll lose the pulse entirely. A series diode that is shorted also causes odd problems. And leakage in those diodes really causes some oddball ones! One is "window-shading:" when the brightness is turned down, the raster goes dark from top to bottom just as though someone were pulling a shade down over it. That would be caused by the vertical-blanking diode. If the raster goes out from left to right, as if someone were pulling a drape across it, that usually means a leaky horizontal-blanking diode.

A shorted horizontal-blanking diode often produces the "jail bars" symptom—there will be five or six black ver-

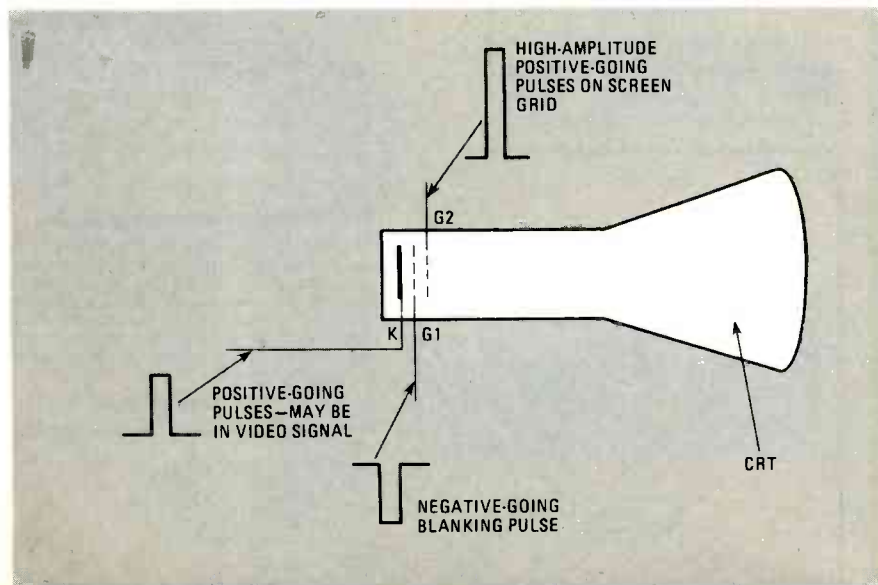



INTERNATIONAL FM-2400CH

# FREQUENCY METER FOR MOBILE TRANSMITTERS/RECEIVERS

Portable • Solid State • Rechargeable Batteries

The FM-2400CH provides an accurate frequency standard for adjustment of mobile transmitters and receivers at predetermined frequencies.

The FM-2400CH with its extended range covers 25 to 1000 MHz.

The frequencies can be those of the radio frequency channels of operation and/or the intermediate frequencies of the receiver between 5 MHz and 40MHz.

Frequency stability: ±.0005% from +50° to +104°F.

Frequency stability with built-in thermometer and temperature corrected charts: ±.00025% from +25° to +125° (.000125% special 450 MHz crystals available).

- Tests Predetermined Frequencies 25 to 1000 MHz
- Pin Diode Attenuator for Full Range Coverage as Signal Generator
- Measures FM Deviation

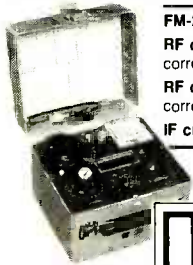

FM-2400CH (meter only) . 690.49  
 RF crystals (with temp. correction) ..... \$28.89 ea.  
 RF crystals (less temp. correction) ..... \$21.92 ea.  
 IF crystals ..... catalog price

Write for catalog



INTERNATIONAL CRYSTAL MFG. CO., INC.  
10 North Lee Oklahoma City, Okla. 73102

CIRCLE 61 ON FREE INFORMATION CARD

## Put Professional Knowledge and a COLLEGE DEGREE in your Electronics Career through

# HOME STUDY

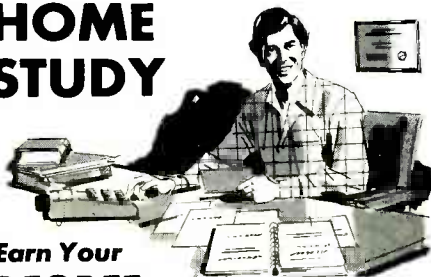

## Earn Your DEGREE

No commuting to class. Study at your own pace, while continuing your present job. Learn from easy-to-understand lessons, with help from your home-study instructors whenever you need it.

In the Grantham electronics program, you first earn your A.S.E.T. degree, and then your B.S.E.T. These degrees are *accredited* by the Accrediting Commission of the National Home Study Council.

Our *free* bulletin gives full details of the home-study program, the degrees awarded, and the requirements for each degree. Write for *Bulletin R-82*.

**Grantham College of Engineering**  
2500 So. LaCienega Blvd.  
Los Angeles, California 90034

tical bars in the picture: the picture will be seen between the bars. Those bars are due to the normally-present series of "ringing pulses" present on the horizontal part of the HV pulse: the shorted diode lets them get through. (It's supposed to clip them off and leave only the spike.)

There are even stranger problems, too. In one old set, we had what looked like retrace lines; closer examination showed that they didn't slant but were almost horizontal, and had flashes of color and bright points in them. After quite a bit of checking, the cause turned out to be a bad integrator circuit in the feedback loop. It was one of the ceramic-types, which looks like a ceramic capacitor with three leads. It was causing a very narrow and sharp top-foldover of the raster; the odd things seen, including the color, were the VITS signals, which are in the vertical-blanking interval.

An oscilloscope is the best piece of test equipment to use with that type of problem, or with any sync problem—you can follow the blanking pulses from their point of origin all the way to their destination, to make sure they get there, or to find the point where they drop out. When you find that point check voltages, components, etc. **R-E**

# SERVICE QUESTIONS

## THIS CAN'T HAPPEN!

This happened with a Magnavox T920 chassis: There was no vertical sync. The set worked fine on the test jig, but not in its cabinet. I tried a new yoke and convergence board with no luck. That left only the picture tube. I had another picture tube in a cabinet with the chassis out, so I used the Magnavox yoke and convergence assembly, slipped the chassis in, and it worked fine. So I replaced the picture tube and now everything's back to normal. I know this isn't supposed to happen, but it did!—*W.S., Houston, TX*  
*I'm sure glad you didn't ask me why!*

## HOT FOLDOVER

*I have a Sylvania EO-9 that develops a bad foldover after it has been run for a while. I've replaced the IC-300 V/H divider and checked many of the resistors and capacitors around it without any luck. I tried cooling things down and found that if I cooled the IC, the picture would straighten out and stay normal for five or ten minutes. I put the original IC back and found that the same thing happens. The schematic shows a voltage regulator, SC310, but I can't find it. Any help would be appreciated.—R.H. Susquehanna, PA*

# WE TAKE YOU BY THE HAND!

You'll learn all about computers: how to build, program, service, even play TV games—without knowing the first thing about it!

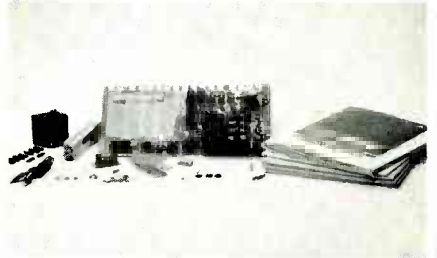

## The New ELF II "Beginners" Package

Your own expandable micro-computer kit, 5 diagnostic analyzers plus circuit, programming, diagnostic manuals, even games you can play on TV. All only \$139.95.

Even if you don't know bits from bytes, now it's easy and inexpensive to build your own micro-computer, learn how it works, program it, service it—even play games with it on your TV! It's here in the New ELF II "Beginners" Package, only from Netronics. Only \$139.95. Here's the package: 1. your own micro-computer, the famous ELF II (featuring the RCA 1802 CMOS microprocessor) in kit form with step-by-step instructions on how to build it. Diagnostic Analyzers including 2. your own Logic Probe, 3. Pulse Catcher, 4. 8 bit Test Register, 5. Logic Analyzer, 6. Gate Arrays, 7. Non-Technical Manuals on how to use analyzers, how to get into the guts of the computer, what makes it tick, how to service it, 8. Sample Programs that teach you machine language programming plus how to correct or "debug" any programming mistakes, 9. TV games you can play. If your TV set has no video input, an optional converter (RF Modulator), is available. Then, once you've got this "Beginners" Package under your belt, keep on expanding your ELF II with additions like the Typewriter Key Board, added RAM, Full Basic Interpreter, Electric Mouth Talking Board, Color/Music, A/D-D/A Boards for Robot Controls and much, much more. We'll take you by the hand with the New ELF II "Beginners" Package. Only \$139.95. Mail or phone in your order today and begin.

Specifications: ELF II "Beginners" Package  
The computer features an RCA CMOS 1802 8 bit microprocessor addressable to 64K bytes with DMA, interrupt, 18 Registers, ALU, 256 byte RAM expandable to 64K bytes, Professional Hex keyboard, fully decoded so there's no need to waste memory with keyboard scanning circuits, built-in power regulator, 5 slot plug-in expansion BUS (less connectors), stable crystal clock for timing purposes and a double-sided, plated through PC Board plus RCA 1861 video IC to display any segment of memory on a video monitor or TV screen along with the logic and support circuitry you need to learn every one of the RCA 1802's capabilities. The diagnostic analyzers aid in understanding and trouble shooting your ELF II, as well as other computer and microprocessor products.

Continental U.S.A. Credit Card Buyers Outside Connecticut

**CALL TOLL FREE 800-243-7428**  
To Order From Connecticut or For Technical Assistance, Etc.,

Call (203) 354-9375

**NETRONICS R&D LTD.**, Dept. RF 92  
333 Litchfield Road, New Milford, CT 06776

Please send the items checked below:

- ELF II "Beginners" Kit ..... \$139.95
- RF Modulator ..... \$ 8.95

Plus \$3.00 for postage, handling and insurance  
( \$6.00 Canada )

Connecticut Residents add sales tax

Total Enclosed \$ \_\_\_\_\_

- Personal Check  Cashier's Check/Money Order
- Visa  Master Charge (Bank No. \_\_\_\_\_)

Acct. No. \_\_\_\_\_

Signature \_\_\_\_\_ Exp. Date \_\_\_\_\_

Print

Name \_\_\_\_\_

Address \_\_\_\_\_

City \_\_\_\_\_

State \_\_\_\_\_

Zip \_\_\_\_\_

MARCH 1982

# Introducing the first no-crystal hand-held scanner.



## The Bearcat® 100.

Now! The one scanner you've always wanted—a no-crystal, fully synthesized hand-held scanner. The incredible, new Bearcat 100.

Push button controls tune in all police calls, fire calls, weather warnings, and emergency information broadcasts, the split second they happen. Automatically.

16 channels for storing frequencies. 8 band coverage—including high, low UHF and "T" public service bands; both the 70 cm and 2 meter amateur bands. Automatic and manual search, lockout, scan delay. Direct channel access. Flexible antenna, earphone, AC adapter/battery charger and carry case are included.

Dial 800-SCANNER (800-722-5555 in Indiana) for your nearest Bearcat Scanner dealer, and go see the world's one and only hand-held, no-crystal scanner.

# BEARCAT® SCANNERS

Electra Company  
Division of Masco Corp. of Indiana  
300 East County Line Road  
Cumberland, Indiana 46229

International Business Office  
Suite 102, 1828 Swift  
North Kansas City, Missouri 64116  
© 1981 Masco Corp. of Indiana

CIRCLE 70 ON FREE INFORMATION CARD

It sounds as if your problem is in the voltages at the IC. You indicated that you measured +5.97 volts at pin three, the  $V_{CC}$  input. That's too high! The correct voltage should be +4.3 volts.

From the parts list, SC310 is a 4.3-volt Zener diode. I'd say that it's either open or missing. Get a 4.3- or 4.7-volt Zener and tie it directly from pin three to ground. That should do the job, and the original IC may still be usable.

### BAD PICTURE TUBE?

*We've got a GE 25YM that was damaged by lightning. We replaced some parts that obviously needed replacing. That didn't work—you turn the set on and the circuit breaker trips. Our old tester told us that the picture tube (25-EKP22) was shorted even though an ohmmeter didn't indicate anything was wrong. What's your opinion?—J.P., Cortez, CO*

I think your picture-tube tester is right. I've run into several sets with the picture tubes shorted so badly that they kill the HV and trip the breaker. (I didn't believe it the first time—the set would run with the HV lead disconnected. On a test jig it gave a perfect picture. So, we changed the picture tube and that was that.)

### NO VIDEO, LOW VOLTAGE

*I have no picture, only a raster with colored horizontal lines, on a Zenith*

*K1908C. Checking, I found only +50 volts on the supply to the video-output module, instead of the +238 volts shown on the schematic. The boost is a bit high, but the HV is normal. The +238 volts is derived from the flyback. Do you think the flyback is bad?—E.M., N. Olmsted, OH*

No, not the flyback. Note that many other voltages that are derived from the flyback are OK: the boost, HV, etc. Your problem is either an open rectifier on that +238-volt source, or something of that sort. Check any resistors that are in series with that supply, between it and the video-output module. The symptoms are not those of a short; that leaves only a bad diode or an open series-resistor as the likely cause.

### HORIZONTAL RIPPLE

*I've got a bad case of what looks like full-wave horizontal ripple in a Sylvania E01-9. I replaced the main filter capacitors, but it's still there. If I disconnect the degaussing coil, the ripple just gets worse. That shouldn't have anything to do with the filtering, should it?—J.T., Memphis, TN.*

No—the degaussing coil isn't involved. I ran into that situation some time back and the problem turned out to be an open diode in the full-wave bridge rectifier. You have a similar case, so check all of the diodes and the solder joints.

R-E

# CLASSIC VALUE

## Model 333 RAPID ASSEMBLY CIRCUIT BOARD HOLDER

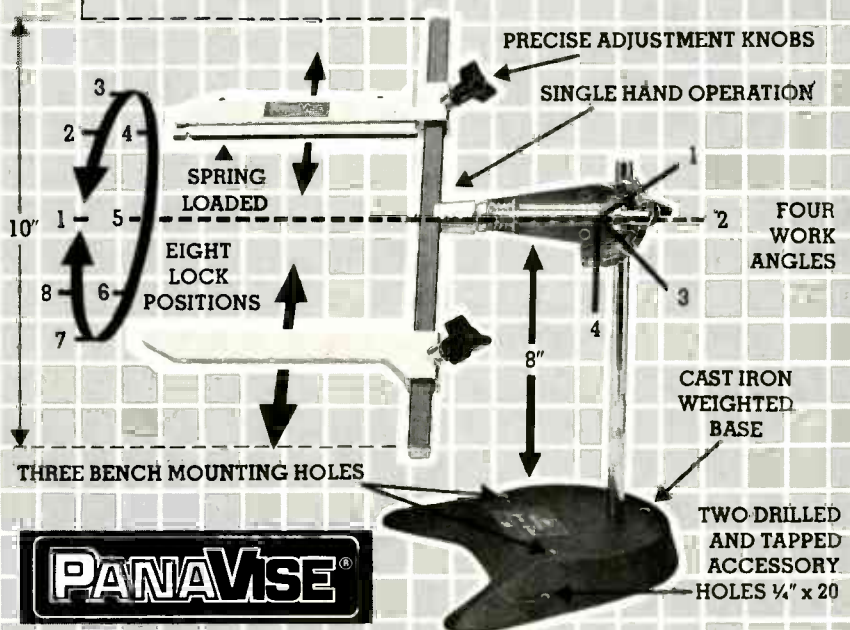

Suggest retail price is \$35.95

Contact your local dealer or PANAVISE today.

PANAVISE PRODUCTS, INC., 2850 E. 29TH ST., LONG BEACH, CA. 90806-(213) 595-7621



# NEW BOOKS

For more details use free information card inside back cover.

**USING MICROCOMPUTERS IN BUSINESS. A Guide for the Perplexed**, by Stanley S. Veit. Hayden Book Company, Inc., 50 Essex Street, Rochelle Park, NJ 07662. 142 pp including appendices and index; 6 x 9 inches; softcover. \$9.95.

This book, written by the man who opened the "second-oldest computer store in the world," is an essential background reference for any purchaser of computer systems or software for a business. It describes the advantage of "computerization" and provides the potential user with the data necessary to make intelligent choices.

Chapters 1 and 2 cover various types of businesses and the programs they need, with reference to the ability of small computers to handle those needs. They are followed by chapters on word processing; data-base management systems; how to install a computer without disrupting your business; buying your system; computer languages; the limitations of the microcomputer; software; where to find it and how to judge it, and what to do when the system goes down. The two final chapters deal with how a microcomputer works and microcomputer memory.

The book has many photos and easy-to-follow diagrams, and is written in plain language, without technical jargon. It answers the most-often-asked questions about computers and offers advice, information, and warnings which have been proved valid.

**CIRCLE 150 ON FREE INFORMATION CARD**

**WHY DO YOU NEED A PERSONAL COMPUTER?** by Lance A. Leventhal and Irvin Stafford. John Wiley & Sons, Inc., One Wiley Drive, Somerset, NJ 08873. 278 pp including appendices and index; 6 3/4 x 10 inches; softcover; \$8.95.

This is a non-technical, fully illustrated, down-to-earth introduction to the world of personal computers. It offers detailed guidelines on the advantages and drawbacks of every type of personal computer; gives sources of equipment and information; provides a step-by-step introduction to the BASIC language, along with an easy-to-follow course in writing programs; information on how to maintain a computer and what to do if it breaks down; a user-directed discussion of peripherals and interfacing, and an extended glossary.

The reader will learn how versatile personal computers are and the many everyday applications they can perform, as well as what will be needed for a useful system and how to select a system that meets the user's personal requirements. Innumerable low-cost personal computers are widely advertised; this book will help the reader to choose among the many offerings and understand what the advertisements really mean.

**CIRCLE 151 ON FREE INFORMATION CARD**

**THE COMPLETE HANDBOOK OF MAGNETIC RECORDING**, by Finn Jorgensen. TAB Books, Inc., Blue Ridge Summit, PA 17214. 448 pp including appendix, additional reading list, and index; 5 1/2 x 8 3/4 inches; softcover; \$10.95.

This textbook of "know-how" and reference, covering all aspects of magnetic recording, is written both for the technically inclined person working in the field and for the equipment user who wants to get in-depth knowledge of magnetic recording equipment and principles.

Chapter 1 gives a brief history, followed by an introduction to recording equipment (chapter 2). The rest of the book falls into three main sections: Fundamentals; Heads, Tapes, and Discs, and Equipment and Application.

The process of recording receives full attention, too: pulse recording and playback; noise; signal detection; equalization bits; error rates; coding; standards; measurements; recording with an AC-bias; amplitude and phase response; SNR improvements; tape drives, and sound-film recording—all are covered in detail, along with FM and PCM recording (including analog-to-digital conversion and high-density digital recording!). **R-E**

**CIRCLE 152 ON FREE INFORMATION CARD**

# From HAMEG...

## HM307

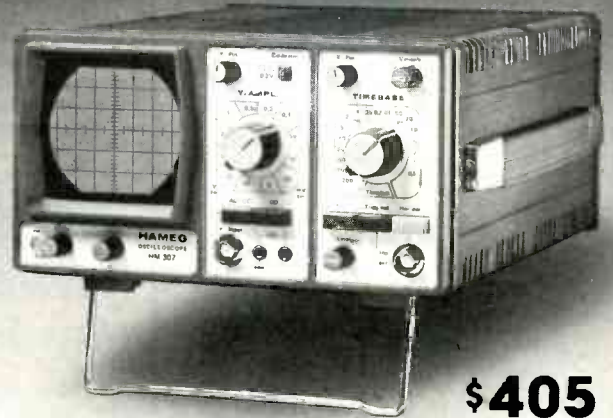

**\$405**

## The first portable scope with a component tester.

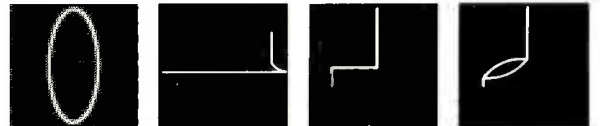

Capacitor 33 uF Transistor E-C Transistor B-E B-E 1 uF + 68 ohms

### Oscilloscope Specifications:

#### Y Deflection

Bandwidth: DC - 10 MHz (-3 dB)  
Overshoot: Less than 1%  
Sensitivity: 5 mV - 20 V/cm  
Input Imp: 1 M ohm // 25 pF

#### X Deflection

Timebase: 0.2s - 0.2 μs/cm  
Triggering: 2 Hz - 30 MHz (3mm)  
Auto + level control  
Bandwidth: 2Hz - 1 MHz

### General Information

|                   |   |
|-------------------|---|
| Component Tester: | For single components and <b>in circuit</b> |
| Calibrator:       | 0.2V ± 1% for probe alignment               |
| Power Supplies:   | Regulated including high voltage            |
| A.C. Input:       | 110, 127, 220, 237, V.A.C., 50 - 60 Hz      |
| Weight:           | 8-1/4 Lbs.                                  |
| Size:             | 4-1/2" H x 8-3/8" W x 10-7/16" D            |

For further information on HAMEG's full line of top performance oscilloscopes, contact:

**HAMEG, INC.**

88 Harbor Rd, Port Washington, N.Y., 11050  
Telephone: 516-883-3837

**CIRCLE 54 ON FREE INFORMATION CARD**

# A 10 HOUR TAPE RECORDER

WAS \$125.00

**NOW only \$95.00\***

LONG PLAY

Modified Panasonic Slimline high quality AC-DC Recorder provides 5 continuous hrs. of recording & side of cassette for a total of 10 hrs. Built-in features include:

- Voice level control
- Auto. tape stop
- Digital counter etc.

TDK DC-180 Cassette included.

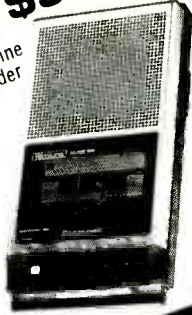

## PHONE RECORDING ADAPTER

Records calls automatically. All Solid state connects to your telephone jack and tape recorder. Starts recording when phone is lifted. Stops when you hang up.

\$24.50\*

FCC APPROVED

## VOX VOICE ACTIVATED CONTROL SWITCH

Solid state. Self contained. Adjustable sensitivity. Voices or other sounds automatically activate and control recorder. Uses either recorder or remote mike. \$24.95\*

\*Add for ship. & hdg. Phone Call Adapter & VOX \$1.50 ea—Recorder \$4.00. Cal. Res. add tax. Mail order, VISA, M/C, cod's ok. Qty. disc. avail. Money back guar. Free data. 9335 Lubec St., Box 928, Downey, CA 90241 Phone (213) 902-8519

CIRCLE 59 ON FREE INFORMATION CARD

# NEW PRODUCTS

For more details use free information card inside back cover.

**GRAPHIC EQUALIZER**, model EQ2400, is a stereo frequency equalizer for the home recordist or music listener. The user can listen to music "flat" while making and monitoring an equalized recording, or



CIRCLE 141 ON FREE INFORMATION CARD

can make and monitor an unequalized tape while listening to music that's equalized to suit the sonic characteristics of one's listening room.

There are ten linear slide controls for each stereo channel, each with true octave spacing calibrated to  $\pm 15$  dB. That will not only improve the sound of the user's cartridge but also remove hiss, rumble, and surface noise.

The model EQ2400 has a frequency response of 10 to 100,000 Hz  $\pm 1$  dB. Total harmonic distortion is less than .01% and intermodulation distortion is less than .02%. There are two main, and two tape-monitor inputs, plus two main and two tape outputs, equalization and defeat selector, and tape-monitor controls. The model EQ2400 can be connected easily to any receiver, pre-amp, or integrated amplifier with tape monitor, signal processor, or pre-amp output. The model EQ2400 is priced at \$199.00. — Numark Electronics Corp., 503 Raritan Center, PO Box 493, Edison, NJ 08817.

**CASSETTE DECK**, model ND-1000, is a two-motor, direct-drive system that assures accurate tape travel. Its three tape heads also add to tape-transport accuracy, while permitting off-the-tape monitoring as well. The transport also features full IC logic control, permitting smooth tape-function switching without

# Reach for reliability.

Solve over 178,000 solid state replacement problems using 1800 SK and KH types. RCA's new Replacement Guide puts the reliable answers at your fingertips.

From foreign to domestic components, RCA simplifies just about any replacement application, including integrated circuits, high-voltage triplers, rectifiers, thyristors and transistors. The guide uses a convenient dual numbering system, which

matches the right SK replacement to your consumer or MRO/Industrial needs. For example: SK3444/123A.

Pick up your copy of the 1982 RCA SK Replacement Guide. Nothing puts reliability within easier reach. See your RCA SK Distributor, or send a check or money order for \$2.25 to: RCA Distributor and Special Products Division, P.O. Box 597, Woodbury, N.J. 08096.



the need to go through the "stop" position. The IC logic permits all tape-mode functions to be turned on from across the room, with the addition of an optional remote-control unit.

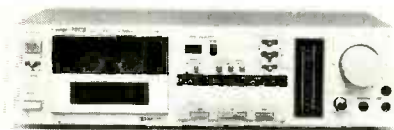

CIRCLE 142 ON FREE INFORMATION CARD

The model ND-1000 accepts metal, normal, and CrO<sub>2</sub> tapes, and applies accurate equalization with each. Other features include two 12-section LED peak-level displays for accurate monitoring, separate left and right level controls, and a front-panel output-level control. Its standard *Dolby B* noise-reduction system is augmented by an MPX filter for interference-free off-the-air recording. There are also an automatic rewind function, a timer-activated record/playback function, and an automatic memory-stop/memory-play function.

The model ND-1000 is priced at \$650.00. — **Nikko Audio**, 320 Oser Avenue, Hauppauge, NY 11787.

**SPECTRUM ANALYZER**, model ESA-1000, is the first such instrument to incorporate bandwidths and detector characteristics mandated by CISPR publications and recommended for FCC-compliance testing, both conducted and radiated. The

model ESA-1000 permits direct visual measurement of electric-field strength, in addition to the conventional spectrum-analyzer capability, to provide a "quick look" at its entire 100 kHz-1000 MHz coverage range. The instrument's scan-rate can be reduced, and accurate measurements taken, using the built-in quasi-peak detector.



CIRCLE 143 ON FREE INFORMATION CARD

There is a complete range of options, including a rechargeable battery pack for field use, and a digital memory module with capability to store data from a slow scan, as required by quasi-peak time constants, and then retrace the scan data at a fast rate for wide-dispersion viewing. The model ESA-1000 is being marketed at a basic price/unit under \$9000.00. — **Penril Corp.**, 5520 Randolph Road, Rockville, MD 20852.

**EARTH STATION RECEIVER**, model ESR24, covers a frequency range of 3.7-4.2 GHz, is designed for satellite-TV recep-

**ILP POWER**  
Compact 4" x 2" x 1"  
**HYBRID AMPLIFIER MODULES**

**HY60**  
**30 watts**  
**\$29.95**

15 Hz — 50 KHz  
THD 0.015%  
S/N ratio 100 db

- \* State-of-the-art performance
- \* Built-in heatsinks
- \* 5 simple connections
- \* Encapsulated circuitry
- \* No external parts required
- \* Five-year warranty

|  |          |
|--|----------|
| Choose from five modules                   |          |
| HY30 (15 watts RMS)                        | \$25.95  |
| HY60 (30 watts RMS)                        | \$29.95  |
| HY120 (60 watts RMS)                       | \$59.95  |
| HY200 (120 watts RMS)                      | \$79.95  |
| HY400 (240 watts RMS)                      | \$99.95  |
| FP480 "Bridges" 2 HY400s for 480 watts RMS | \$200.00 |

**GLADSTONE Electronics**

901 Fuhrmann Blvd., Phone Orders  
Buffalo, New York, 14203. (716) 849-0735

Name \_\_\_\_\_  
Address \_\_\_\_\_  
City \_\_\_\_\_ Zip \_\_\_\_\_ Amt. \_\_\_\_\_  
Please send \_\_\_\_\_  
Check ( ) M/O ( ) Visa ( ) M/C ( )  
Number \_\_\_\_\_ Exp. \_\_\_\_\_

CIRCLE 65 ON FREE INFORMATION CARD

**The new**  
**1982 RCA SK**  
**Replacement Guide.**

**RCA SK Series**  
**1982**  
Guide to Reliable Replacements  
• Consumer • Industrial/MRO  
Over 178,000 Solid State Replacement Recommendations

**RCA** SK Replacement  
Solid State

## BASIC TRAINING

Learn to write concise, effective programs in BASIC with two great books from Sams.

**BASIC PROGRAMMING PRIMER**, by Mitchell Waite and Michael Pardee, is an excellent, user-friendly guide to BASIC-language programming fundamentals. It's ideal for beginning or advanced computerists, and comes with a handy, tear-out reference card listing condensed BASIC commands.

**BASIC PROGRAMMER'S NOTEBOOK** contains a number of programming secrets and shortcuts usually known only to highly experienced programmers, as well as workable ways to trim both the size and the running time of some of your larger programs. Program statements are in Level II BASIC, but most of the concepts can readily be translated to other BASIC dialects.

Complete your BASIC training with Sams, America's leader in the field of microcomputer knowledge!



**SAMS BOOKS**

Mail to: Howard W. Sams & Co., Inc., 4300 West 62nd St., P.O. Box 7092, Indianapolis, IN 46206

|                             |                                      |         |       |
|-----------------------------|--------------------------------------|---------|-------|
| BASIC PROGRAMMING PRIMER    | No. 21586                            | \$11.95 | _____ |
| BASIC PROGRAMMER'S NOTEBOOK | No. 21841                            | \$12.95 | _____ |
|                             | Amount of Order                      | \$      | _____ |
|                             | Add Handling Costs                   | \$      | 2.00  |
|                             | Add Local Sales Tax Where Applicable | \$      | _____ |
|                             | Total Amount of Order                | \$      | _____ |

Payment Enclosed:  Check  Money Order  
 VISA  MasterCard Interbank No. \_\_\_\_\_  
 Account No. \_\_\_\_\_  
 Expiration Date \_\_\_\_\_  
 Name (Print) \_\_\_\_\_  
 Signature \_\_\_\_\_  
 Address \_\_\_\_\_  
 City \_\_\_\_\_ State \_\_\_\_\_ Zip \_\_\_\_\_

Call toll free 800-428-3696 for the name of your local Sams Book outlet or to order by phone (give Sams Operator the code number in the box below). Offer good in U.S.A. only. Offer expires 6/30/82. Prices subject to change without notice.

AD154

**CIRCLE 69 ON FREE INFORMATION CARD**

tion, and features digital channel-display, preset and variable audio subcarrier selector, automatic frequency-control for stability, and full metering. For installation

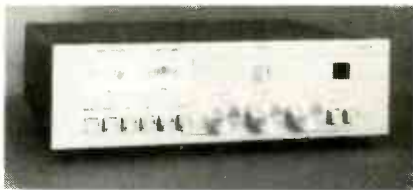

**CIRCLE 144 ON FREE INFORMATION CARD**

versatility, the down-converter module (supplied) may be mounted internally, or at the antenna. Accessories for the model ESR24 include remote control, a remote tuning-meter, and splash-proof housing. The styling makes it suitable for commercial or private installations. The model ESR24 is priced at under \$1000.00.—**R.L. Drake, Company**, 540 Richard St., Miamisburg, OH 45342.

**SPEAKERS**, *Ohm Walsh 2*, have inverted transducers that radiate a measurable coherent wave front into the total frontal listening area. That special method of coherent sound-propagation provides

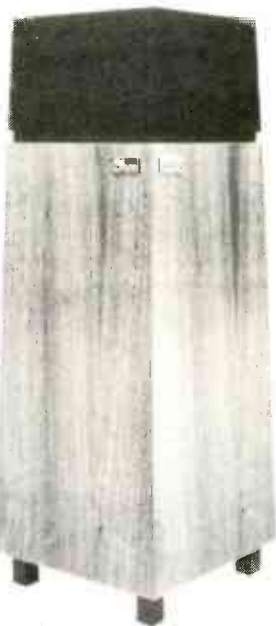

**CIRCLE 145 ON FREE INFORMATION CARD**

virtually perfect stereo imaging and energy response from any listening position. The speakers are finished in genuine walnut veneer on all four sides; they are also available in oak, teak, and rosewood veneers at increased cost. They measure 31½ × 11½ inches, can be driven by as little as 20 watts, and have a maximum power handling of 120 watts. The *Ohm Walsh 2* speakers are priced at \$275.00 each.—**OHM Acoustics Corp.**, 241 Taaffe Place, Brooklyn, NY 11205.

**CW COMPUTER-INTERFACE**, model MFJ-1200, converts audio from your receiver to TTL or RS-232 so your computer can "understand" it. It also lets your computer-output "key" your transmitter. When combined with a personal computer and an

**High stability Crystals for frequency or time. Use the best.**

- CB
- 2 meter
- Industry
- Marine VHF
- CB standard
- Amateur VHF
- General
- Communication
- Micro processor crystals

Send for our latest catalog. Write or phone for more details.  
 Jan Crystals  
 P.O. Box 0607  
 Ft. Myers, Florida 33906  
 all phones (813) 936-2397

easy to charge

**JAN CRYSTALS**

**CIRCLE 60 ON FREE INFORMATION CARD**

## COMPUTERS

|  |         |                        |
|--|---------|------------------------|
| Complete Microprocessors line, peripherals & Terminals |         |                        |
| Green Monitor  | 169.00  | SOROC IO 135 795.00    |
| Leedex 100 Mon   | 139.00  | TI-99/4 399.00         |
| Visicalc   | 160.00  | Epson MX-80 call us    |
| Microsoft Z/80   | 320.00  | Color Monitor call us  |
| IDS 445G   | call us | TI-810 1395.00         |
| TI-745   | 1440.00 | 80 Column Board 299.00 |

## Texas Instruments

|              |          |               |          |
|--------------|----------|---------------|----------|
| Invest. Anal | \$ 42.00 | TI-59         | \$175.00 |
| Accessories  | Call us  | TI-55 II      | 39.95    |
| TI-58C       | 80.00    | Speak & Spell | 49.95    |
| PC100C       | 155.00   | TI Programmer | 47.95    |
| TI BAII      | 39.00    | MBA           | 49.95    |

## HEWLETT-PACKARD

|                 |         |                   |         |
|-----------------|---------|-------------------|---------|
| HP/125 Computer | call us | HP-11C NEW        | call us |
| HP/37E          | \$60.00 | HP-12C NEW        | call us |
| HP-33C          | 70.00   | HP-41C Mem Module | 26.00   |
| HP-34C          | 115.00  | HP-41CV           | 245.00  |
| HP-38C          | 114.99  | HP-67             | 295.00  |
| HP-41C Prog     | 189.00  | HP-97             | 570.00  |
| HP-41C Printer  | 285.00  | Quad Ram          | call us |
| HP-41C CRD RDR  | 169.00  | Application Pac   | call us |
|                 |         | HP/85             | 2195.00 |

## SCM TYPEWRITER SPECIALS

|          |          |            |          |
|----------|----------|------------|----------|
| SCM 2200 | \$279.00 | INTREPID   | \$274.00 |
| SCM 2500 | 289.00   | CLASSIC 12 | 159.00   |

All units shipped in original cartons with accessories according to manufacturer's specification. Send money orders, personal check 2 weeks to clear. In Illinois add 6% sales tax. Add \$6.95 minimum shipping & handling charges per unit. We ship UPS. Subject to availability. Written warranty for specific products can be obtained free upon request. Above prices are for mail order and prepaid only. Prices and specifications subject to change without notice. Send mail orders.

**Nabik's, Inc.**

519 DAVIS EVANSTON, ILL. 60201 TEL 312-869-6144



appropriate program, it can give you a complete and versatile CW keyboard/reader combination.

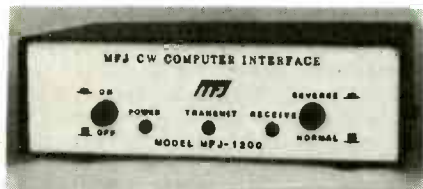

CIRCLE 146 ON FREE INFORMATION CARD

For receiving CW, the *model MFJ-1200* processes the received CW audio from your rig to provide a clean, computer-compatible TTL or RS-232 level. First it limits the noise on incoming CW signals, then filters it to remove interfering signals, sends the desired signal through a detection stage, post-filters the detected signal, shapes the signal, and finally shifts the level of the signal to TTL or RS-232 so that your computer can use it.

For transmitting CW, the *model MFJ-1200* takes keyboard-generated CW at TTL or RS-232 output levels from your computer and drives high-voltage keying circuits to key your tube or solid-state transmitter (-300 volts, 10mA maximum, +300 volts, 100mA maximum).

The *model MFJ-1200* has three red LED's to indicate tuning, transmit mode, and "on". A REVERSE/NORMAL switch will invert the output level to the computer, if desired. It operates on 6- to 9-volts DC or 110-volts AC, with the optional *MFJ-1309* AC supply (\$9.95). The *model MFJ-1200* is

priced at \$69.95, plus \$4.00 for shipping and handling.—**MFJ Enterprises, Inc.**, PO Box 494, Mississippi State, MS 39752.

**PARALLEL PRINTER INTERFACES**, *model A4P* and *model A8P* (shown) are designed for the Atari line of microcomputers. They allow the *Atari 400* or *Atari 800* to drive a parallel ASCII printer directly. A cable assembly plugs into controller jacks 3 & 4 on the front of the Atari microcomputer. A short (15-second) program is read into the computer from cassette; from then on, all printer data is directed to the parallel-printer interface, instead of to the Atari serial port. For example, LIST#P will list a BASIC program on the printer, LPRINT in a BASIC program will directly output to the printer, and LIST#P: will list assembler

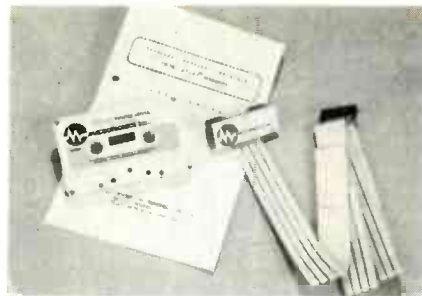

CIRCLE 147 ON FREE INFORMATION CARD

source listings on the printer.

The program will remain in memory until the computer power is turned off—it is unaffected by SYSTEM RESET, BREAK, ESC, OPTION, SELECT, or START. The interface

## Enjoy the game now...tape pay TV for later!

### The Switcher does it all for you.

Suppose you want to watch the football game, but there's a great movie you've been waiting to see on pay TV. Which do you pass up?

With The Switcher—and your video recorder—you can enjoy the game—and tape the movie for viewing later. In fact, you can watch any program on regular TV channels while you tape pay TV or cable TV. You can even watch pay or cable TV as you tape "off air" from regular channels!

**Installs in minutes  
...no special tools!**

The Switcher comes fully equipped with cables and hardware for easy installation you do yourself. Better yet, once it's installed, there's no plugging and unplugging to do. Just a touch of the controls gets you the viewing you want.

**Take advantage of this  
incredibly low price!**

Most switching devices run \$89.95 to \$129.95. A few, like The Switcher, are regularly just \$69.95. Now, for a limited time, we're offering The Switcher for only \$39.95 plus shipping and handling! Order yours today!



**ONLY  
\$39.95**

plus \$2.00  
shipping  
& handling.

**CALL TOLL-FREE  
800-228-5600**

(Nebraska residents call  
800-642-8777)

If you prefer, fill  
out the coupon  
below and mail to:

3001 Malmo Road  
Arlington Heights  
Illinois 60005



**VIDEO PLAYGROUND, 3001 Malmo, Arlington Hts., IL 60005**

**YES!** Send me \_\_\_\_\_ Switcher(s) at only \$39.95 each plus \$2.00 each for shipping & handling. (Illinois residents add 6% sales tax.)

I enclose check or money order  
 Master Card  Visa account #

Sig. \_\_\_\_\_  
(charge orders must be signed)

Name \_\_\_\_\_  
(please print)

Address \_\_\_\_\_

City \_\_\_\_\_ State \_\_\_\_\_ ZIP \_\_\_\_\_

Interbank # \_\_\_\_\_ Exp. date \_\_\_\_\_

**MAIL TODAY!** DEPT. 119

## TeleMatic

**PROFESSIONAL COLOR TV  
SERVICE EQUIPMENT**

**Modernizes any test jig**



Model 10J107

### UPDATE KIT

Unique transverter system with  
9 HORIZONTAL & 5 VERTICAL  
IMPEDANCE SELECTIONS and  
special matching yoke.

### ADAPTERS FOR ALL MAKES OF JIGS



To  
service  
all  
domestic and  
imported TVs.

WRITE FOR FREE CATALOG

Sold through distributors only  
**TeleMatic Div. of U.X.L. Corp.**  
108-02 Otis Ave., Corona, NY 11368

CIRCLE 66 ON FREE INFORMATION CARD

**TOOL STORES**  
A PRODUCT OF D.I. INDUSTRIES, INC.

# SEARCH NO MORE!

Never again waste valuable time & money searching for a certain size or type nut, bolt, rivet, nail, whatever. We've got just about every kind of fastener, part, and piece of hardware you'll ever need! Plus installation and removal tools. And a complete line of parts organizers.

**IT'S A HARDWARE STORE  
AT YOUR FINGERTIPS!**

Send \$1.00 for a fully illustrated catalog (refundable with first order)

D.R.I. Industries, Inc. Dept. RE-382  
11100 Hampshire Ave. So.,  
Bloomington, MN 55438

89678

**TO RECEIVE YOUR CATALOG, COMPLETE THIS  
AND MAIL WITH \$1.00 CHECK OR MONEY ORDER  
(refundable with first order) TO:**

D.R.I. Industries, Inc.  
11100 Hampshire Ave. So., Bloomington, MN 55438

MR. \_\_\_\_\_  
MRS. \_\_\_\_\_  
MISS \_\_\_\_\_

NAME First M.I. Last

ADDRESS \_\_\_\_\_  
Street & Number

City State Zip



## Digital Multimeter

The Drake DM2350 Digital Multimeter is a convenient, small handheld liquid crystal display meter ideal for the serviceman or hobbyist. This 3 1/2 digit meter is auto-ranging, auto-zeroing, has polarity indication, and an over-range warning signal. Battery life is greater than 300 hours with a "low battery" indicator. A continuity test sounds a signal when circuit resistance is less than 20 ohms. Dc accuracy is a basic 0.8%.

Batteries, probes, 20 amp current shunt, spare fuse and soft carrying case all included at \$95.95

Add \$2.50 shipping and handling per order.

Send check with order and provide street address for UPS shipment. Ohio residents add Sales Tax. Charge card buyers may call toll free.

1-800-543-5613



In Ohio, or for information call:  
1-513-866-2421

**R. L. DRAKE COMPANY**

540 Richard Street, Miamisburg, Ohio 45342

INSTITUTIONAL AND DEALER INQUIRIES INVITED.

**CIRCLE 62 ON FREE INFORMATION CARD**

works equally well with BASIC, DOS, or the Atari Assembler/Debug. It will work with virtually any program that directs printer data through the IOCB. It will work with machine-language programs that do not reside in or clear memory locations 0700H to 07AAH.

The model A4P is for the Atari 400, while the model A8P is for the Atari 800 microcomputer. Both have the same price: \$69.95.—Macrotonics, Inc., 1125 N. Golden State Blvd., Suite G, Turlock CA 95380.

**BUS-BAR SNAP-AROUND**, model SPR-1030, is designed and engineered for 3-inch bus-bar measurements, as well as for use on round cable up to 2 1/16 inches OD. The scale, which rotates for easier readings, has continuous duty for every range.

There are five current ranges up to 1000-amps AC and three voltage scales up to 750-volts AC (self-contained); the unit comes with a one-piece Ohmprobe for both resistance and continuity testing. Full-scale accuracy on signals from 50-400



**CIRCLE 148 ON FREE INFORMATION CARD**

H<sub>z</sub> is ±3%. Safety features include shock-resistant ABS plastic housings; twist and lock threaded voltage leads; fully insulated jaws, and the ability to withstand overloads. The model SPR-1030 comes with carrying case, voltage test leads, Ohmprobe fused battery attachment; battery; fuse, and operating instructions. It is priced at \$124.95. — A.W. Sperry Instruments, Inc., 245 Marcus Blvd., Hauppauge, NY 11787.

**GRAPHIC PRINTER**, model VIC 1515, is designed to go with the model VIC 20 personal computer. The model VIC 1515, which can print any of the alphabetic, numeric, and graphic characters common to the model VIC 20, is a dot-matrix printer with a speed of 30 characters per second. It allows the model VIC 20 user to



**CIRCLE 149 ON FREE INFORMATION CARD**

## An enclosure as good as your idea.

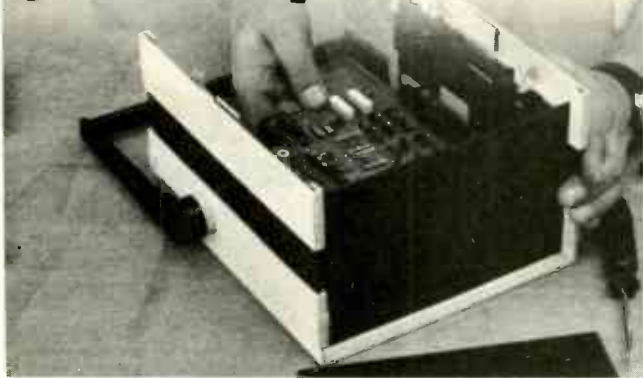

You've turned a good idea into a piece of equipment—now you need a good enclosure. Here's how PacTec can help you with our versatile enclosures:

- Attractive yet inexpensive.
- Durable ABS construction.
- Many sizes, colors, accessories.
- Built in bosses and slots speed component mounting.
- Available off-the-shelf from single unit to production quantities. See them at your PacTec Distributor. And ask him for your free catalog.



**PACINTEC** Corp.  
subsidiary of La France Corp.  
Enterprise and Executive Avenues  
Philadelphia, PA 19153 (215) 365-8400

**CIRCLE 56 ON FREE INFORMATION CARD**

## DON'T FORGET

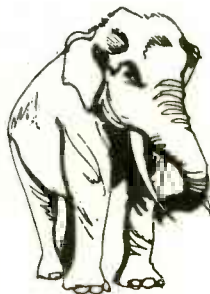

USE  
YOUR  
READER  
SERVICE  
CARD



# Be an FCC LICENSED ELECTRONIC TECHNICIAN!



Earn up to \$600 a week and more!

Learn at home in spare time. No previous experience needed!

No costly School. No commuting to class. The Original Home-Study course that prepares you for the FCC Radio-telephone license exam in your spare time! Passing the exam is you "ticket" to thousands of exciting opportunities in Communications, Broadcasting, Mobile two-way systems, Microwave stations, Radar installations, Aerospace and more.

### NO NEED TO QUIT YOUR JOB OR GO TO SCHOOL

You learn how to pass the FCC License exam at home at your own pace with this easy-to-understand, proven course. Within a few short weeks you could be on your way to being one of the highest paid workers in the electronics field. It's that easy! U.S. Federal law requires you to have an FCC License if you want to operate and maintain *virtually any communications system* — you don't need a College degree to qualify, but you DO need an FCC License. With this Home-Study course, you'll be ready to pass the FCC Government licensing exam in a remarkably short time. Send for FREE facts now. No obligation. No salesmen will call. **MAIL COUPON TODAY!**

## COMMAND PRODUCTIONS

FCC LICENSE TRAINING, Dept. E  
P.O. Box 2223, San Francisco, CA 94126

Rush FREE facts on how I can prepare for my FCC License at home in my spare time.

NAME \_\_\_\_\_  
ADDRESS \_\_\_\_\_  
CITY \_\_\_\_\_ STATE \_\_\_\_\_ ZIP \_\_\_\_\_

**CIRCLE 64 ON FREE INFORMATION CARD**

## Power Line Filters



Model LF6

Model LF2

These filters protect any sensitive electronic equipment from power line transient damage and radio frequency interference. Both models offer common mode and differential mode surge suppression for power line "spikes". Rf interference is suppressed using both inductive and capacitive components. Ideal for computers, test equipment or TV.

LF2 a duplex outlet, 120V, 8 amps max. . . . \$39.95  
LF6 three separately filtered duplex outlets, 120 V, total fused capacity 15 amps, power switch and indicator lamp . . . . . \$59.95  
Add \$2.50 shipping and handling per order.

Send check with order and provide street address for UPS shipment. Ohio residents add Sales Tax. Charge card buyers may call toll free:

1-800-543-5613



**DRAKE**

In Ohio, or for information call: 1-513-866-2421

### R. L. DRAKE COMPANY

540 Richard Street, Miamisburg, Ohio 45342

INSTITUTIONAL AND DEALER INQUIRIES INVITED

**CIRCLE 63 ON FREE INFORMATION CARD**

get hard copy for forms, program listings, mailing labels, charts, graphs, and more. Special enhancements also allow it to print extra-wide and reversed (white-on-black) characters. The VIC 1515 is priced at \$395.00.—**Commodore Business Machines, Inc.**, 681 Moore Road, King of Prussia, PA 19406.

**SATELLITE-TV ANTENNA**, the *Skyview IV*, is a lightweight, 11-foot fiberglass parabolic-antenna designed for lost-cost shipping, expandability, and ease of operation. It is expandable to 13 feet by adding exterior panels. Installation requires only a simple, three-foot-square concrete pad and four holes.

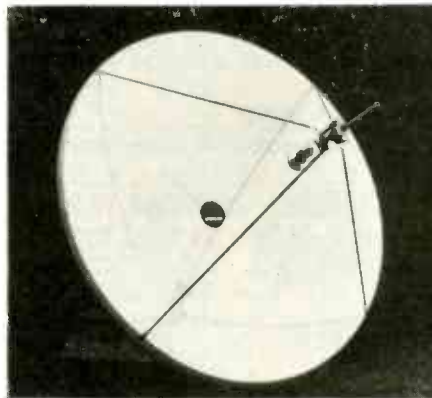

**CIRCLE 150 ON FREE INFORMATION CARD**

The *Skyview IV* weighs 400 pounds, including mount, and has better protection against wind (125-mile-load survival rating), rough handling, and weather than conventional aluminum construction. It is easy to operate; it can be shifted from satellite to satellite with a simple hand-crank adjustment, and can receive all North American communications satellites.

The *Skyview IV* is priced at \$1945.00.

Also available is the *Skyview IV System*, a complete home satellite-TV receiving system based on the *Skyview IV* parabolic antenna and including a *D-2X* receiver, 120° LNA, RF modulator, and all cabling. The price is \$4595.00.—**Downlink, Inc.**, 30 Park Street, Putnam, CT 06260. **R-E**

## CHANNEL 1?

*continued from page 46*

television reception. The television industry, although not pleased about losing yet another TV channel, agreed that 12 clear channels were preferable to 12 shared channels. If they had to lose a channel, they preferred that it be Channel 1, because its absence would have the least impact on commercializing television.

The FCC went along with the television industry's position, and on June 14, 1948, Channel 1 was deleted from the allocation plan. Channel 1's frequencies were assigned to the fixed land and mobile services. At the same time, the FCC decided not to renumber the channels—that's what happened to Channel 1! **R-E**

## AFFORDABLE AUTORANGING

# DMM's

From **SOAR corporation**

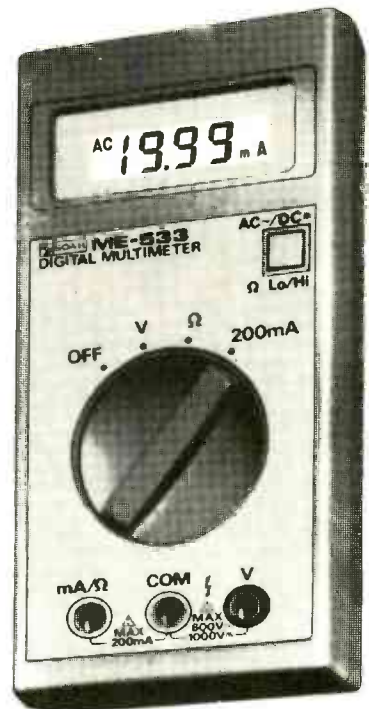

- Full autoranging for AC/DC volts, current and Hi/Lo Pwr.  $\Omega$  for fast, easy use. Touch button diode test.
- Advanced Micro-Circuit design with reduced parts count for long term reliability.
- Heavy duty ABS plastic case with display window cover for rugged field use.
- Annunciators indicate "AC" mV, mA,  $\Omega$ , k $\Omega$ , plus numerical value for error free readings.
- Auto decimal, polarity and low battery indicator.
- Electronic or fuse overload protection for all functions, just in case . . .
- Continuity beeper on Models ME-531 and ME-532 for "No-Look" circuit checkout.
- 10 Ampere AC/DC current ranges-on ME-531.
- Operates 300 hrs on two "AA" cells.
- Complete with batteries, spare fuse, test leads, full one year ltd. warranty.

|              |         |
|--------------|---------|
| MODEL ME-533 | \$75.00 |
| ME-532       | 85.00   |
| ME-531       | 99.50   |

Available at selected Distributors or write/phone:

**NORTH AMERICAN**



1126 Cornell Avenue, Cherry Hill, NJ 08002  
Tel. (609) 488-1060

**CIRCLE 68 ON FREE INFORMATION CARD**

# MARKET CENTER

## SATELLITE TV TONIGHT LIVE!

- DISH ANTENNA
- PREAMPLIFIER
- RECEIVER **\$399**

MDS COMPLETE RECEIVING SYSTEM READY FOR TV HOOK-UP

### SATELLITE T.V. INC.

P.O. Box 3618, DEPT. RE-3  
LANTANA, FL. 33462

SEND \$9.95 PLUS \$2.50 SHIPPING & HANDLING OR CALL OUR 24 HR. C.O.D. ORDER LINE (305) 845-3840

NAME \_\_\_\_\_  
ADDRESS \_\_\_\_\_



### \$295 SATELLITE ANTENNA (10 FT. X 10 FT.) FOR THE DO-IT-YOURSELFER

JUST PUBLISHED — MAGNIFICENTLY ILLUSTRATED DIAGRAMS — GRAPHS — EXTENSIVE PHOTO — GRAPHS — MAJOR SOURCES — ANTENNAS — LOW NOISE AMPLIFIERS — RECEIVERS AND MORE.

THIS AMAZING BOOK DESCRIBES THE ENTIRE FIELD OF SATELLITE TRANSMISSION AND RECEPTION WITH THE THOROUGHNESS OF AN ENCYCLOPEDIA. ONE CAREFUL STEP AT A TIME OUR COMPREHENSIVE BOOK HAS BEEN WRITTEN SO THAT EVEN A BEGINNER CAN EASILY UNDERSTAND THE SIMPLIFYING TECHNOLOGY BECAUSE WE MADE IT SO EASY TO LEARN.

NOW YOU CAN HAVE A 100 PLUS CHANNEL RECEPTION SYSTEM AND ENJOY EVERYTHING BEING TELECAST IN THE WORLD.

## SATELLITE TELEVISION

SATELLITE TV antenna, 10 ft. fiberglass, complete, polar mount, \$1950.00, electronics at cost also. **TRI-STAR COMMUNICATIONS**, Box 843, Erie, MI 48133 (419) 726-1095

**FREE \$200 value TVRO P.C. board set**, when you join our development group. Complete systems low as \$700. Newest low cost designs, antennas, group purchasing, more. Info \$1.00, membership \$50. 509-534-8088 6-9 PM PST. **COMPUTER SATELLITE SERVICES**, 1604 N. Smith St., Spokane WA 99207

SATELLITE TV. Books, parts, low-noise microwave transistors. Specs and catalog \$2.00. **ELITE ELECTRONICS**, RR1, St. George, Ontario, Canada N0E 1N0

**GEOSTATIONARY satellite TV antenna aiming angles**. Azimuth and elevation (true and magnetic) coordinates calculated by digital computer for your location. 23 satellites. Send name, address, your location's latitude and longitude (deg. min. sec.); or distance and direction from nearby town; or explicit geographical location in your city; plus \$6.50 to: **HUTSON INDUSTRIES, INC.**, P.O. Box 155, Scooba, MS 39358

SATELLITE equipment catalog. Over 25 of the best manufacturers and suppliers. LNA's, receivers, antennas and complete systems covered in detail. Four different sections. \$12.00. **TMS CO.**, P.O. Box 8369, Roseville, MN 55113

To run your own classified ad, put one word on each of the lines below and send this form along with your check for \$1.65 per word (minimum 15 words to):

**Radio-Electronics, 200 Park Avenue South, N.Y., N.Y. 10003**

### ORDER FORM

PLEASE INDICATE in which category of classified advertising you wish your ad to appear. For special headings, there is a surcharge of \$10.

- ( ) Plans/Kits ( ) Business Opportunities ( ) For Sale  
( ) Education/Instruction ( ) Wanted ( )

Special Category: \$10

(PLEASE PRINT EACH WORD SEPARATELY, IN BLOCK LETTERS.)

|    |    |    |    |    |
|----|----|----|----|----|
| 1  | 2  | 3  | 4  | 5  |
| 6  | 7  | 8  | 9  | 10 |
| 11 | 12 | 13 | 14 | 15 |
| 16 | 17 | 18 | 19 | 20 |
| 21 | 22 | 23 | 24 | 25 |
| 26 | 27 | 28 | 29 | 30 |
| 31 | 32 | 33 | 34 | 35 |

PLEASE INCLUDE FOR OUR FILES YOUR PERMANENT ADDRESS AND PHONE NUMBER.

## Satellite TV

### FOR THE HOME

#### Sick of Network TV?

Our receiver lets you get over 75 channels of television directly from earth-orbiting cable TV satellites! HBO, Showtime, super stations, sports and movies worldwide.

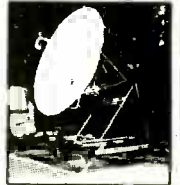

**We don't just sell information! We Manufacture Hardware!**

From offshore oil rigs, data links to hotels and backyard installations, we wrote the book. Constantly updated, our 94 Page technical information book and catalog gives you all the facts. Inexpensive dishes, feeds, telemetry software, kits and more. Recommended reading by NASA, The Office of Consumer Affairs and quality companies like Rockwell/Collins. Send \$7.95 today!

CALL  
24-hr. C.O.D. Hotline  
(305) 339-7600

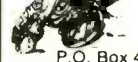

**SPACECOAST**

RESEARCH CORPORATION

P.O. Box 442-E, Altamonte Spgs, FL 32701

**INTERESTED in Home Satellite Television** — Don't buy anything until you've read the **HOME-SAT HANDBOOK & BUYERS GUIDE**. Our book tells everything about home satellite TV and may save you hundreds, even thousands of dollars in your selection and installation of a system! \$7.50; also: **Homesat Monthly Newsletter**, one year, \$5. Order both for only \$12. **H & G HOMESAT SERVICES**, Box 422, Seaford, NY 11873

### SATELLITE TELEVISION EARTH STATION KIT LOW COST COMPLETE SYSTEM

Special Offer \$2,995.00

Kit includes all electronic and mechanical parts needed to assemble a complete operating Earth Station. You provide the labor and hand tools.

Included in the kit are a 12-foot fully steerable parabolic dish, low noise amplifier, antenna, rotator, receiver, modulator, necessary cables/connectors and complete assembly/operating instructions. EVERYTHING — down to the last nut, bolt and screw is provided.

Illustrated Brochure with Complete Details — \$2.00

**MICROTENNA ASSOCIATES**  
2335 South, 2300 West  
Salt Lake City, Utah 84119



### SATELLITE TV FANTASTIC 80 TV CHANNELS

New antenna construction plans plus big 8x11 book loaded with aiming info, kits, LNAs and receivers at wholesale prices. Far better than cable TV! Enjoy crystal clear reception. Send \$9.95 today. Add \$2.00 for 1st class (air mail) or call our 24 hr. COD order line (305) 862-5068 Now

Global TV Electronics, P.O. Box 219-F, Maitland, FL 32751

**SATELLITE TV Antenna** — We make the best 10 foot fiberglass dish in the Midwest!!! Receive 75 TV channels direct from the satellite. We have openings for dealers. For complete spec's and satellite TV information send \$2.25 for postage and handling to **SPACE ANTENNAS**, 127 W. 10, KCMO. 64105.

### Satellite Earth Station complete systems from \$2,200.00

Send \$4.00 for our complete 50 page color catalog

**TEI ELECTRONICS**  
P.O. Box 181108, Dept. 286A, Memphis, TN. 38118  
901-795-4504



## Visit our NEW WESTBORO SHOWROOM Outlet - Over \$10,000,000 of devices in stock!

133 Flanders Road, Westboro, Massachusetts (617) 366-0500

### TTL STANDARD AND LOW POWER SCHOTTKY

|         |      |         |      |          |      |
|---------|------|---------|------|----------|------|
| 7400N   | 23   | 74165N  | 69   | 74LS125N | 49   |
| 7401N   | 25   | 74170N  | 69   | 74LS132N | 58   |
| 7402N   | 24   | 74172N  | 1.75 | 74LS133N | 58   |
| 7403N   | 24   | 74173N  | 3.95 | 74LS134N | 49   |
| 7404N   | 26   | 74174N  | .66  | 74LS136N | 42   |
| 7405N   | 26   | 74175N  | .66  | 74LS138N | 42   |
| 7406N   | 36   | 74176N  | .77  | 74LS139N | 55   |
| 7407N   | 41   | 74177N  | .77  | 74LS145N | 1.09 |
| 7408N   | 26   | 74178N  | 1.17 | 74LS147N | 1.96 |
| 7409N   | 28   | 74179N  | 1.35 | 74LS148N | 1.43 |
| 7410N   | 26   | 74180N  | .75  | 74LS151N | 43   |
| 7412N   | 35   | 74182N  | .52  | 74LS153N | 42   |
| 7413N   | 44   | 74183N  | 1.39 | 74LS156N | 87   |
| 7414N   | 44   | 74185N  | 2.36 | 74LS156N | 87   |
| 7416N   | 36   | 74190N  | .75  | 74LS157N | 48   |
| 7417N   | 36   | 74191N  | .75  | 74LS158N | 48   |
| 7420N   | 25   | 74192N  | .75  | 74LS160N | 79   |
| 7422N   | 45   | 74193N  | .75  | 74LS161N | 75   |
| 7423N   | 29   | 74194N  | .75  | 74LS162N | 84   |
| 7425N   | 32   | 74196N  | .79  | 74LS163N | 85   |
| 7426N   | 32   | 74197N  | .79  | 74LS164N | 58   |
| 7427N   | 32   | 74197N  | .79  | 74LS165N | 89   |
| 7428N   | 48   | 74199N  | 1.39 | 74LS166N | 1.64 |
| 7430N   | 23   | 74200N  | 1.59 | 74LS167N | 1.59 |
| 7432N   | 38   | 74221N  | 6.38 | 74LS173N | .72  |
| 7433N   | 42   | 74246N  | 1.70 | 74LS174N | .44  |
| 7437N   | 38   | 74247N  | 1.50 | 74LS175N | .50  |
| 7438N   | 42   | 74251N  | 8.9  | 74LS181N | 1.99 |
| 7440N   | 25   | 74259N  | 1.89 | 74LS189N | 4.45 |
| 7442N   | 52   | 74276N  | 1.19 | 74LS190N | 85   |
| 7445N   | 69   | 74278N  | 2.36 | 74LS191N | 85   |
| 7446N   | 79   | 74279N  | .76  | 74LS192N | .74  |
| 7447N   | 79   | 74280N  | 1.70 | 74LS193N | .74  |
| 7450N   | 25   | 74293N  | .95  | 74LS197N | .88  |
| 7451N   | 29   | 74298N  | .84  | 74LS197N | .88  |
| 7453N   | 49   | 74310N  | 2.20 | 74LS240N | 1.25 |
| 7454N   | 29   | 74355N  | 4.9  | 74LS241N | 1.25 |
| 7457N   | 36   | 74366N  | .59  | 74LS242N | 1.25 |
| 7458N   | 35   | 74367AN | .56  | 74LS243N | 1.25 |
| 7474N   | 35   | 74370AN | .56  | 74LS244N | 1.25 |
| 7475N   | 47   | 74371AN | .56  | 74LS245N | 1.25 |
| 7476N   | 35   | 74393N  | 1.49 | 74LS247N | .84  |
| 7483AN  | 1.96 | 74LS00N | .21  | 74LS248N | 1.09 |
| 7484AN  | 1.96 | 74LS01N | .22  | 74LS249N | 1.32 |
| 7485N   | .66  | 74LS02N | .24  | 74LS251N | .69  |
| 7486N   | .35  | 74LS03N | .24  | 74LS252N | .69  |
| 7490AN  | 36   | 74LS04N | .25  | 74LS257N | 1.49 |
| 7491AN  | 50   | 74LS05N | .25  | 74LS259N | 69   |
| 7492AN  | 42   | 74LS06N | .25  | 74LS260N | 1.25 |
| 7495AN  | 38   | 74LS07N | .24  | 74LS266N | 1.18 |
| 7496AN  | .65  | 74LS10N | .24  | 74LS275N | 3.39 |
| 7498AN  | .59  | 74LS11N | .28  | 74LS279N | .44  |
| 7497N   | 1.80 | 74LS12N | .28  | 74LS280N | .50  |
| 74100N  | 1.30 | 74LS13N | .36  | 74LS283N | .59  |
| 74104N  | .64  | 74LS14N | .48  | 74LS285N | .79  |
| 74109N  | 40   | 74LS15N | .48  | 74LS293N | .79  |
| 74110N  | 52   | 74LS16N | .50  | 74LS299N | .89  |
| 74111N  | 72   | 74LS17N | .29  | 74LS299N | 2.89 |
| 74116N  | 1.38 | 74LS27N | .29  | 74LS320N | 2.75 |
| 74120N  | 1.38 | 74LS28N | .29  | 74LS322N | 4.95 |
| 74121N  | 1.38 | 74LS29N | .29  | 74LS323N | 4.95 |
| 74122N  | 1.38 | 74LS30N | .29  | 74LS324N | 3.25 |
| 74123N  | 48   | 74LS31N | .29  | 74LS324N | 3.25 |
| 74125N  | 48   | 74LS32N | .29  | 74LS325N | 1.28 |
| 74126N  | 48   | 74LS33N | .29  | 74LS325N | 1.28 |
| 74127N  | 48   | 74LS34N | .29  | 74LS326N | 1.28 |
| 74128N  | 48   | 74LS35N | .29  | 74LS365N | .59  |
| 74136N  | 52   | 74LS36N | .29  | 74LS366N | .59  |
| 74141N  | 85   | 74LS37N | .35  | 74LS367N | .59  |
| 74142N  | 2.95 | 74LS38N | .44  | 74LS371N | 1.39 |
| 74143N  | 3.44 | 74LS39N | .44  | 74LS372N | 1.39 |
| 74144N  | 3.44 | 74LS40N | .44  | 74LS373N | 1.39 |
| 74145N  | 67   | 74LS41N | .44  | 74LS374N | 1.39 |
| 74147N  | 1.50 | 74LS42N | .44  | 74LS375N | 1.39 |
| 74148N  | 69   | 74LS43N | .44  | 74LS376N | 1.39 |
| 74149N  | 69   | 74LS44N | .44  | 74LS377N | 1.39 |
| 74150N  | 1.25 | 74LS45N | .44  | 74LS378N | 1.39 |
| 74151N  | 54   | 74LS46N | .44  | 74LS379N | 1.39 |
| 74153N  | 49   | 74LS47N | .44  | 74LS380N | 1.39 |
| 74154N  | 1.25 | 74LS48N | .44  | 74LS381N | 1.39 |
| 74155N  | 58   | 74LS49N | .44  | 74LS382N | 1.39 |
| 74156N  | 58   | 74LS50N | .44  | 74LS383N | 1.44 |
| 74159N  | 1.52 | 74LS51N | .44  | 74LS384N | 1.44 |
| 74160N  | 60   | 74LS52N | .44  | 74LS385N | 1.44 |
| 74161AN | 69   | 74LS53N | .44  | 74LS386N | 1.44 |
| 74162AN | 69   | 74LS54N | .44  | 74LS387N | 1.44 |
| 74163AN | 69   | 74LS55N | .44  | 74LS388N | 1.44 |
| 74164AN | 69   | 74LS56N | .44  | 74LS389N | 1.44 |
| 74165AN | 69   | 74LS57N | .44  | 74LS390N | 1.44 |
| 74166AN | 69   | 74LS58N | .44  | 74LS391N | 1.44 |
| 74167AN | 69   | 74LS59N | .44  | 74LS392N | 1.44 |
| 74168AN | 69   | 74LS60N | .44  | 74LS393N | 1.44 |
| 74169AN | 69   | 74LS61N | .44  | 74LS394N | 1.44 |
| 74170AN | 69   | 74LS62N | .44  | 74LS395N | 1.44 |
| 74171AN | 69   | 74LS63N | .44  | 74LS396N | 1.44 |
| 74172AN | 69   | 74LS64N | .44  | 74LS397N | 1.44 |
| 74173AN | 69   | 74LS65N | .44  | 74LS398N | 1.44 |
| 74174AN | 69   | 74LS66N | .44  | 74LS399N | 1.44 |
| 74175AN | 69   | 74LS67N | .44  | 74LS400N | 1.44 |
| 74176AN | 69   | 74LS68N | .44  | 74LS401N | 1.44 |
| 74177AN | 69   | 74LS69N | .44  | 74LS402N | 1.44 |
| 74178AN | 69   | 74LS70N | .44  | 74LS403N | 1.44 |
| 74179AN | 69   | 74LS71N | .44  | 74LS404N | 1.44 |
| 74180AN | 69   | 74LS72N | .44  | 74LS405N | 1.44 |
| 74181AN | 69   | 74LS73N | .44  | 74LS406N | 1.44 |
| 74182AN | 69   | 74LS74N | .44  | 74LS407N | 1.44 |
| 74183AN | 69   | 74LS75N | .44  | 74LS408N | 1.44 |
| 74184AN | 69   | 74LS76N | .44  | 74LS409N | 1.44 |
| 74185AN | 69   | 74LS77N | .44  | 74LS410N | 1.44 |
| 74186AN | 69   | 74LS78N | .44  | 74LS411N | 1.44 |
| 74187AN | 69   | 74LS79N | .44  | 74LS412N | 1.44 |
| 74188AN | 69   | 74LS80N | .44  | 74LS413N | 1.44 |
| 74189AN | 69   | 74LS81N | .44  | 74LS414N | 1.44 |
| 74190AN | 69   | 74LS82N | .44  | 74LS415N | 1.44 |
| 74191AN | 69   | 74LS83N | .44  | 74LS416N | 1.44 |
| 74192AN | 69   | 74LS84N | .44  | 74LS417N | 1.44 |
| 74193AN | 69   | 74LS85N | .44  | 74LS418N | 1.44 |
| 74194AN | 69   | 74LS86N | .44  | 74LS419N | 1.44 |
| 74195AN | 69   | 74LS87N | .44  | 74LS420N | 1.44 |
| 74196AN | 69   | 74LS88N | .44  | 74LS421N | 1.44 |
| 74197AN | 69   | 74LS89N | .44  | 74LS422N | 1.44 |
| 74198AN | 69   | 74LS90N | .44  | 74LS423N | 1.44 |
| 74199AN | 69   | 74LS91N | .44  | 74LS424N | 1.44 |
| 74200AN | 69   | 74LS92N | .44  | 74LS425N | 1.44 |
| 74201AN | 69   | 74LS93N | .44  | 74LS426N | 1.44 |
| 74202AN | 69   | 74LS94N | .44  | 74LS427N | 1.44 |
| 74203AN | 69   | 74LS95N | .44  | 74LS428N | 1.44 |
| 74204AN | 69   | 74LS96N | .44  | 74LS429N | 1.44 |
| 74205AN | 69   | 74LS97N | .44  | 74LS430N | 1.44 |
| 74206AN | 69   | 74LS98N | .44  | 74LS431N | 1.44 |
| 74207AN | 69   | 74LS99N | .44  | 74LS432N | 1.44 |
| 74208AN | 69   | 74LS00N | .44  | 74LS433N | 1.44 |
| 74209AN | 69   | 74LS01N | .44  | 74LS434N | 1.44 |
| 74210AN | 69   | 74LS02N | .44  | 74LS435N | 1.44 |
| 74211AN | 69   | 74LS03N | .44  | 74LS436N | 1.44 |
| 74212AN | 69   | 74LS04N | .44  | 74LS437N | 1.44 |
| 74213AN | 69   | 74LS05N | .44  | 74LS438N | 1.44 |
| 74214AN | 69   | 74LS06N | .44  | 74LS439N | 1.44 |
| 74215AN | 69   | 74LS07N | .44  | 74LS440N | 1.44 |
| 74216AN | 69   | 74LS08N | .44  | 74LS441N | 1.44 |
| 74217AN | 69   | 74LS09N | .44  | 74LS442N | 1.44 |
| 74218AN | 69   | 74LS10N | .44  | 74LS443N | 1.44 |
| 74219AN | 69   | 74LS11N | .44  | 74LS444N | 1.44 |
| 74220AN | 69   | 74LS12N | .44  | 74LS445N | 1.44 |
| 74221AN | 69   | 74LS13N | .44  | 74LS446N | 1.44 |
| 74222AN | 69   | 74LS14N | .44  | 74LS447N | 1.44 |
| 74223AN | 69   | 74LS15N | .44  | 74LS448N | 1.44 |
| 74224AN | 69   | 74LS16N | .44  | 74LS449N | 1.44 |
| 74225AN | 69   | 74LS17N | .44  | 74LS450N | 1.44 |
| 74226AN | 69   | 74LS18N | .44  | 74LS451N | 1.44 |
| 74227AN | 69   | 74LS19N | .44  | 74LS452N | 1.44 |
| 74228AN | 69   | 74LS20N | .44  | 74LS453N | 1.44 |
| 74229AN | 69   | 74LS21N | .44  | 74LS454N | 1.44 |
| 74230AN | 69   | 74LS22N | .44  | 74LS455N | 1.44 |
| 74231AN | 69   | 74LS23N | .44  | 74LS456N | 1.44 |
| 74232AN | 69   | 74LS24N | .44  | 74LS457N | 1.44 |
| 74233AN | 69   | 74LS25N | .44  | 74LS458N | 1.44 |
| 74234AN | 69   | 74LS26N | .44  | 74LS459N | 1.44 |
| 74235AN | 69   | 74LS27N | .44  | 74LS460N | 1.44 |
| 74236AN | 69   | 74LS28N | .44  | 74LS461N | 1.44 |
| 74237AN | 69   | 74LS29N | .44  | 74LS462N | 1.44 |
| 74238AN | 69   | 74LS30N | .44  | 74LS463N | 1.44 |
| 74239AN | 69   | 74LS31N | .44  | 74LS464N | 1.44 |
| 74240AN | 69   | 74LS32N | .44  | 74LS465N | 1.44 |
| 74241AN | 69   | 74LS33N | .44  | 74LS466N | 1.44 |
| 74242AN | 69   | 74LS34N | .44  | 74LS467N | 1.44 |
| 74243AN | 69   | 74LS35N | .44  | 74LS468N | 1.44 |
| 74244AN | 69   | 74LS36N | .44  | 74LS469N | 1.44 |
| 74245AN | 69   | 74LS37N | .44  | 74LS470N | 1.44 |
| 74246AN | 69   | 74LS38N | .44  | 74LS471N | 1.44 |
| 74247AN | 69   | 74LS39N | .44  | 74LS472N | 1.44 |
| 74248AN | 69   | 74LS40N | .44  | 74LS473N | 1.44 |
| 74249AN | 69   | 74LS41N | .44  | 74LS474N | 1.44 |
| 74250AN | 69   | 74LS42N | .44  | 74LS475N | 1.44 |
| 74251AN | 69   | 74LS43N | .44  | 74LS476N | 1.44 |
| 74252AN | 69   | 74LS44N | .44  | 74LS477N | 1.44 |
| 74253AN | 69   | 74LS45N | .44  | 74LS478N | 1.44 |
| 74254AN | 69   | 74LS46N | .44  | 74LS479N | 1.44 |
| 74255AN | 69   | 74LS47N | .44  | 74LS480N | 1.44 |
| 74256AN | 69   | 74LS48N | .44  | 74LS481N | 1.44 |
| 74257AN | 69   | 74LS49N | .44  | 74LS482N | 1.44 |
| 74258AN | 69   | 74LS50N | .44  | 74LS483N | 1.44 |
| 74259AN | 69   | 74LS51N | .44  | 74LS484N | 1.44 |
| 74260AN | 69   | 74LS52N | .44  | 74LS485N | 1.44 |
| 74261AN | 69   | 74LS53N | .44  | 74LS486N | 1.44 |
| 74262AN | 69   | 74LS54N | .44  | 74LS487N | 1.44 |
| 74263AN | 69   | 74LS55N | .44  | 74LS488N | 1.44 |
| 74264AN | 69   | 74LS56N | .44  | 74LS489N | 1.44 |
| 74265AN | 69   | 74LS57N | .44  | 74LS490N | 1.44 |
| 74266AN | 69   | 74LS58N | .44  | 74LS491N | 1.44 |
| 74267AN | 69   | 74LS59N | .44  | 74LS492N | 1.44 |
| 74268AN | 69   | 74LS60N | .44  | 74LS493N | 1.44 |
| 74269AN | 69   | 74LS61N | .44  | 74LS494N | 1.44 |
| 74270AN | 69   | 74LS62N | .44  | 74LS495N | 1.44 |
| 74271AN | 69   | 74LS63N | .44  | 74LS496N | 1.44 |
| 74272AN | 69   | 74LS64N | .44  | 74LS497N | 1.44 |
| 74273AN | 69   | 74LS65N | .44  | 74LS498N | 1.44 |
| 74274AN | 6    |         |      |          |      |



## BUSINESS OPPORTUNITIES

**MECHANICALLY** inclined individuals desiring ownership of Small Electronics Manufacturing Business - without investment. Write: **BUSINESS**, 92-R, Brighton 11th, Brooklyn, NY 11235

### HIGHLY PROFITABLE ONE-MAN ELECTRONIC FACTORY

Investment unnecessary, knowledge not required, sales handled by professionals. Ideal home business. Write today for facts! **Postcard will do, Barta-RE-W, Box 248, Walnut Creek, CA 94597.**

**WINNERS!** Build on your technical skills to create a successful computer business. Free report tells how. **SEABIRD PRESS**, Box 461T, Lexington, MA 02173

**LAWYER** Business litigation, patents, appeals. **JEROME FIELD**, B 292, Brooklyn 11230. Phone (212) 434-0781. Eves. 434-1825

## EDUCATION & INSTRUCTION

**UNIVERSITY** degrees by mail! Bachelors, Masters, Ph.D's... Free revealing details. **COUNSELING**, Box 317-RE3, Tustin, CA 92680

**ATTENTION ELECTRONIC TECHNICIANS**



Highly Effective Home Study BSEE Degree Program for Experienced Electronic Technicians. Our New Advanced Placement Program grants Credit for previous Schooling & Professional Experience. Advance Rapidly! Our 36th Year! FREE DESCRIPTIVE LITERATURE!

**Cook's Institute of Electronics Engineering**  
DESK 45, P.O. BOX 20345, JACKSON, MS 39209

**SUBSCRIPTION** television education manual. Complete theory in circuits \$9.95. **D & S ENTERPRISES**, PO Box 110901RE, Nashville, TN 37211

**FREE KIT Catalog**

FUNCTION GENERATOR KIT \$59.95 contains TEST & EXPERIMENTER'S EQUIP.  
Auto-Ranging Cap-meter kit \$79.95

**Phone 415-447-3433**

Write or Phone for FREE CATALOG. Average 1 minute Saturday call is 21¢.

**DAGE SCIENTIFIC INSTRUMENTS**  
BOX 1054R LIVERMORE CA 94550

## PLANS & KITS

**OSCILLOSCOPE** performance from your unmodified television for less than \$25. Super simple, accurate, practical. Order Tele-Scope circuit board and plans \$8.50. Get two for dual trace \$15. **MICROGRID**, Box 613, Ithaca, NY 14850

**THEY TALK - YOU LISTEN!**



Improve your monitoring receivers with unique accessories. Preamps, descramblers, notch filters, active antennas, preselectors, multi-couplers, frequency lists, beam antennas and more.

**FREE CATALOG FREE**

**GROVE ENTERPRISES, INC.** Dept. J, Brasstown, NC 28902

**KIRLIAN** photography as a hobby. Complete plans for do-it-yourself machine. Includes easy instructions and ways to improve quality of prints. \$5.00. **C.E.L.C. ELECTRONICS**, P.O. Box 805, Missouri City, TX 77459

**NEGATIVE ion generators.** Send for free information to **THE SEAWARD COMPANY**, P.O. Box 2039, Burbank, CA 91507

**MICROWAVE** downconverter kit \$169.00. Includes everything. Informative catalog on subscription TV products \$2.00. **J & W ELECTRONICS**, P.O. Box 61, Cumberland, RI 02864

**SATELLITE** TVRO parabolic aluminum dish, local materials \$500. Plans, formulas \$10.00. **WARD MICROWAVE**, Box 100, Conway, NC 27820

**DECODE** Morse, RTTY, and ASCII signals from airwaves with new **Code\*Star**. LED readout or connect with your computer/printer. Keyboard, other items also available. Kits or assembled. **MICROCRAFT**, Box 513R, Thiensville, WI 53092 (414) 241-8144

**WERSI KEYBOARD KITS**



**WERSI** Organs are demonstrably superior in overall performance, to ALL commercially built instruments, regardless of price. Best of all, you save 1/2 to 2/3 the cost with our easy to build kits. (Also factory assembled).

And now - after 3 years in research, the totally unprecedented "Pianostar" electronic piano (and much more!) has been unveiled to international raves! You have to hear it to believe it!

Explore the exciting world of **WERSI**. Free information package. Call free, 24 hrs.: 1-800-233-3865 (in PA call: 717/299-4327, 9-5)

Ask for "WERSI DATA PAK #M33" Please specify Piano or Organ

**MICROWAVE** television "downconverters" under \$50.00. High quality, easily assembled. Catalogue: \$2.00 (refundable). **NDS**, Box 12652-R, Dallas, TX 75225

**PCB**. 15c sq-in. Free drilling. Satisfaction guaranteed. **INTERNATIONAL ENTERPRISE**, 6452 Hazel Circle, Simi Valley, CA 93063

**MUSICAL** car horn 64 tunes. No chips to buy. Kit with case less horn. \$31.95. Factory assembled with horn. \$41.95. Add \$2.50 shipping. **ELECTRONIC SOUND**, P.O. Box 401951, Garland, TX 75040

**MICROWAVE HORN ANTENNA KIT**

1.7-26 GHz Frequency Range 17-19 db Gain Kit w/Assembly Instructions \$39.95\*  
Down Converter Board \$19.95\* (w/Antenna Kit \$14.95)  
Parts Kit for Board \$29.95\* (w/Antenna or Board \$24.95)  
Complete Package (Antenna, Board & Parts Kit) \$79.95



**MICROANTENNA ASSOCIATES**  
2335 South 2300 West, Salt Lake City, Utah 84119  
Check or M.O. only - Allow 2-4 Weeks; Delivery (Cost includes shipping)  
\*Utah Residents Please Add 5% Sales Tax

**PRINTED** circuit boards from sketch or artwork. Kit projects. Free details. **DANOCINTHS INC.**, Box 261, Westland, MI 48185

**CABLE TV** converters and equipment. Plans and parts. Build or buy. For information send \$2.00. **C & D ELECTRONICS**, PO Box 21, Jenison, MI 49428

**CATALOG** of electronic designs. Radio, audio, telephone, self defense & surveillance. Also 100 **MPG carburetors**. Free details. **PETER-SCHMITT ENTERPRISES**, #131, Box 07071, Milwaukee, WI 53207-0071.

**ELECTRONIC** catalog. Over 4,500 items. Parts & components. Everything needed by the hobbyist or technician. \$2.00 postage & handling (United States only). refundable with first \$15.00 order. **T & M ELECTRONICS**, 474 East Main Street, Patchogue, NY 11772 (516) 289-2520

**MINI FM MIC**



Compact size, only 2"x1"x3/4". Transmit to FM radio 88-108 MHz. Exceptional audio quality. Transmits stable signal up to 900 ft. Complete kit incl. case, battery & instructions. Only \$13.95. Assembled \$18.95. Add \$1.55 S&H ea. Send 18c stamp for brochure.

**S.E. Corp.**, Box 16969-R  
Temple Terrace, FL 33687

**ELECTRO-music** kits. Touch-sensitive electronic pianos; string synthesizers; programmable drums and orchestral generators; electronic organ rotors. **G&R ADVANCED ELECTRONIC DESIGNS, INC.**, P.O. Box 38, Streetsville, Ontario, L5M 2B7.

**SUBSCRIPTION TV PLANS:** 2300 MHz Microwave Downconverter plus BONUS UHF system, both for \$15.00! Best systems available, no internal connections to TV. Parts, PCB's, Kits available, MC/VISA accepted. Other plans: Negative Ion Generator, Telephone Memory Dialer, UHF/VHF Antenna Amplifier, Wireless FM Intercom, \$4.00 each. Send SASE for more information. **COLLINS ELECTRONICS**, Box 5624, San Bernardino, CA 92412

# COMPUTER MARKET CENTER

**COMPUTER MARKET CENTER ADVERTISING RATES** 1" by 1 column (1 5/8") \$55.00. 1 1/2" by 1 column (1 5/8") \$82.50. 2" by 1 column (1 5/8") \$110.00. All ads must be prepaid. Send order and remittances to Computer Market Center, **Radio-Electronics Magazine**, 200 Park Avenue South, New York, New York, 10003. Address telephone inquiries to 212-777-6400. Frequency rates are available.

## TEXAS

USED COMPUTER TERMINALS, PRINTERS, MODEMS, SURPLUS ELECTRONIC PARTS. CATALOG \$1.00

**RONDURE COMPANY**  
THE COMPUTER ROOM  
2522 BUTLER STREET  
DALLAS, TEXAS 75235  
(214) 630-4621

**RETAILERS**

An ad for your computer store in this space in **Radio-Electronics COMPUTER MARKET CENTER** puts you in touch with our computer audience. They use micro-computer equipment for both business and hobby interests. For further details call 212-777-6400.

**BUY THIS SPACE**

\$55.00 puts your ad in this space in front of 197,223 active **Radio-Electronics** readers. To place your ad write Computer Market Center, **Radio-Electronics**, 200 Park Avenue South, New York, New York 10003 or call 212-777-6400.

1941

**HOME AWAY FROM HOME**



Ed McMahon here to wish USO a Happy Birthday. Thanks, USO for 40 years of championship service.

**Ed McMahon**

40th Anniversary

1981

Thanks to you...it works... for ALL OF US



**United Way**

A Public Service of This Magazine & The Advertising Council

**SUPPORT MARCH OF DIMES**



**Take stock in America. Buy U.S. Savings Bonds.**



# LEARN ABOUT S-100 COMPUTERS.

S-100 computers are the next logical step up after 'personal' computers, whether for business, professional, or scientific applications. These three books are a must for technicians, students, systems integrators, or anyone who wants to know more about S-100 computers.

**'Interfacing to S-100/ IEEE 696 Microcomputers'**, by Sol Libes and Mark Garetz. Spells out operating requirements and characteristics with clarity and precision. 17 chapters cover busing techniques, parallel and serial interfacing, handshaking, bus signals and timing relationships, I/O ports, interrupts, A/D and D/A conversion, much more. Osborne/McGraw-hill; softcover; 321 pages. \$15.00

**'Product User Manuals 1975-1980, Volume 1'**, by CompuPro. With schematics, test routines, operating information for 29 CompuPro products (RAM and ROM memories, motherboards, CPU 8085/8088 dual processor board, CPU-Z, interfacers, etc.). Also defines and explains the S-100 bus. Excellent reference on memories and CPU boards. Softcover; 8.5in x 11in. format; 256 pages; \$20.

**'Product User Manuals, Volume 2'**, by CompuPro. Similar to above, but covers System Support 1, Disk 1, RAM 17 CMOS memory, Interfacer 3, STD RAM, STD CPU, STD motherboard, and and more. Softcover; 8.5in. x 11in. format; 307 pages; \$25.

**CompuPro**™

division

**GODBOUT**  
ELECTRONICS

OAKLAND AIRPORT, CA 94614-0355 (415)562-0636

TERMS: Cal res add tax. Allow 10% shipping; excess refunded. VISA® and Mastercard® orders (\$25 minimum) call (415) 562-0636, 24 hrs. Include street address for UPS. Prices subject to change without notice.

## CIRCLE 21 ON FREE INFORMATION CARD



### MICROWAVE KIT

**\$89<sup>95</sup>** CONVERTS  
MICROWAVE TO  
VHF TELEVISION

COMPLETE INSTRUCTIONS,  
HARDWARE, POWER SUPPLY  
& YAGI ANTENNA.

**CLEAR-VUE ELECTRONICS**  
P.O. Box 600, Rochester, MI 48063  
313-375-9730

**THE Intelligence Library.** Restricted technical secrets—books on **electronic surveillance, lock-picking, demolitions, investigation, etc.** Free brochures: MENTOR, Dept. Z, 135-53 No. Blvd., Flushing, NY 11354

**PICTURE tube rebuilding equipment**—we sell and buy new and used equipment. Free training. **ATOLL TELEVISION**, 6425 Irving Park, Chicago, IL 60634. Phone 312-545-6667

**MICROWAVE 2 GHz.** Best in the West! Down-converter kits \$39.00. Complete with antenna and control box \$99.00. Factory assembled — 90-day warranty \$159.00. **GALAXY ELECTRONICS**, 6007 N. 61st Ave., Glendale AZ 85301 (602) 247-1151

**CHEMICALS**, apparatus, project books, wide selection. Catalog \$1.00 send to: **PIONEER Ltd.** Ind, 14a Hughey St., Nashua, NH 03060

**COLLECTOR** items: full set Sam's Photofact. Volume 1 - 20, some TV repair manuals, assorted Rider manuals, all excellent condition. **DOUG VAN DYCK**, 617 N. Holly St., Medford, OR 97501 (503) 779-5612.

**ELECTRONIC** equipment, Panasonic gear, metal detectors, satellite TV systems. **SCHAFFER ENTERPRISES**, Box 1362, Brookings, OR 97415

**2150 megahertz downconverters** \$99.95 up, assembled. Details for **SASE. GW ELECTRONICS**, POB 688, Greenwood, IN 46142

**REVERBERATION** for organs and keyboards — Simply connected to any electronic organ, even those with multiple outlet channels. Room size and reverberation time adjustable. Nothing comparable in this price range is offered on the market. Send for free brochure. **DEVTRONIX ORGANS, INC.**, Dept. 60, 6101 Warehouse Way, Sacramento, CA 95826

### A SINGER'S DREAM!

TVE

**REMOVES VOCAL FROM MOST STEREO DISCS**

The Thompson Vocal Eliminator can actually remove most or virtually all of a solo vocalist from a standard stereo record and yet leave most of the background music untouched! Not an equalizer! We can prove it, works over the phone. Write or call for a 24 page brochure and demo record.

Writes to: **LT Sound**, Dept. R, P.O. Box 338, Stone Mountain, GA 30386. Phone: (404) 993-1258. COST: \$29.95

**TOUCH-TONE** Decoder chip. Only one chip needed to decode DTMF signals. Includes crystal and spec sheet. \$64.50. Send for free catalog on others. **NELRAD COMMUNICATIONS**, Box 150, Webster, MN 55088.

**TUBES.** Retired repairman's stock. SASE for details. **KASDUE**, 506 E. La Paloma Lane, Roswell, NM 88201

**TI 58/59 users** — have fun with your calculator. Two games available. Treasure Island — protect your gold from pirates. Sticks — whoever takes the last stick loses. \$3.00 each. **PREMIER SIFT-WARD**, PO Box 12011, Austin, TX 78711

**BIPOLAR ±15V @ 50 mA** powersupply. 10 mV regulation. 0.1 mV ripple. Kit only \$12.95 plus \$2.00 shipping. **SOUND CONCEPTS**, Brookline, MA 02146

**POWER-AMP sub-assemblies**, 100 watts rms. .05% distortion, completely assembled and tested. for more information write to: **CLAXTON AUDIO**, 3174 Periwinkle, Memphis TN 38127

**SYNTHESIZER** module P11. 100 continuous direct binary coded channels at 10 KHz steps. 38 MHz out; with schematic, specs, application notes. ppos to **PRESTON**, 7 Doris Place, East Islip, NY 11730

## COMPUTER SOFTWARE

**HP-41C** software. Electronics, engineering, business applications. Free information. **SOFTWARE SPECIALISTS, INC.**, Dept. RE/1, Box 329, Springboro, OH 45066

## CB RADIO

**GET more CB channels and range!** Frequency Expanders, boosters, speech processors, FM converters, ignition noise blankers, how-to books, plans, modifications. Catalog \$2. **CB CITY**, Box 31500RE, Phoenix, AZ 85046

## WANTED

**WANTED, large quantities of surplus electronic parts/computer boards/motors, etc.** Anything for the home constructor considered. Send full details, samples, prices to: **TRADE SURPLUS, 75/77 Hayfield Road, Salford, Manchester, M6 8QA, England.** Telephone 061 743 1184, Telex 665383 TRADA G.

## COMPUTERS

**SAVE 90%.** Build your own computer, CRT, and interfaces. Free details. **DIGATEK CORPORATION**, Suite E, 2723 West Butler Drive, Phoenix, AZ 85021

## CASSETTES/REEL-TO-REEL TAPES

**OPEN reel tape**—mostly Ampex, used once, unspliced, unboxed. 1800' 50 reels; \$65.00. Sample: \$2.00. 3600' 10 reels; \$25.00. Sample: \$2.50. New, premium C-60 cassettes; sample: \$1.00. **AUDIO TAPES**, Box 9584-G, Alexandria, VA 22304

## ATTENTION WRITERS

**DO you want to write your own book?** We're looking for electronics writers to do just that. Obtain our electronics needs list, or send your own ideas, by writing to Liz Akers, Acquisitions Editor, **TAB BOOKS, Inc.**, Blue Ridge Summit, PA 17214 (717 - 794-2191).

## FOR SALE

**MICROWAVE** receiver system. Write: "Dealers Wanted," Dept. RE, POB 4181, Scottsdale, AZ 85258 (602)941-9345

**VARIETY** electronic surplus parts and equipment in our monthly picture flyer. Send \$2.00 for 6 issues. **STAR-TRONICS**, POB 683, McMinnville, OR 97128

**SCANNER/monitor** accessories—kits and factory assembled. Free catalog. **CAPSI ELECTRONICS**, Route 1R, Canon, GA 30520

**POLICE/fire** scanners, scanner crystals, antennas, radar detectors. **HPR**, Box 19224, Denver, CO 80219

**TEST equipment**, new and used. Catalog \$1.00. **PTI**, Box 8756, White Bear Lake, MN 55110. (612) 429-2975

**FREE speaker catalog!** Woofers, mids, tweeters, hardware, crossovers, grille cloth, plans, kits, information, much more. Discount prices. **UNIVERSAL SOUND**, Dept. RE, 2253 Ringling Blvd., Sarasota, FL 33577, (813) 953-5363

**SAVE up to 50%** on name brand test equipment. Free catalog and price list. **SALEN ELECTRONICS**, Box 82-F, Skokie, IL 60077

**TELEPHONE** or office bugged? Latest detection equipment finds out fast. Literature \$1.00. **CLIFTON**, Box 220-M, Miami, FL 33168



WRITE FOR  
**McGEE'S**  
SPEAKER & ELECTRONICS CATALOG

1001 BARGAINS IN SPEAKERS

Tel.: 1 (816) 842 5092

1901 MCGEE STREET KANSAS CITY, MO. 64108

**LOW TIM DC STEREO PRE-AMP KIT TA-10 20**

Incorporates brand-new D.C. design that gives a frequency response from 0Hz-100KHz  $\pm 0.5dB$ ! Added features like tone defeat and loudness control let you tailor your own frequency supplies to eliminate power fluctuation! Specifications: • T.H.D. less than .005% • T.I.M. less than .005% • Frequency response: DC to 100KHz  $\pm 0.5dB$  • RIAA deviation:  $\pm 0.2dB$  • S/N ratio: better than 70dB • Sensitivity: Phono 2MV 47K/Aux. 100MV 100K • Output level: 1.3V • Max output: 15V • Tone control: bass  $\pm 10dB$  @ 50Hz/treble  $\pm 10dB$  @ 15Hz • Power supply:  $\pm 24$  D.C. @ 0.5A  
Kit comes with regulated power supply, all you need is a 48V C.T. transformer @ 0.5A.

**ONLY \$44.50**  
X'former  
**\$4.50 ea.**



**100W CLASS A POWER AMP KIT**

Dynamic Bias Class "A" circuit design makes this unit unique in its class. Crystal clear, 100 watts power output will satisfy the most picky fans. A perfect combination with the TA-1020 low T.I.M. stereo pre-amp. Specifications:

- Output power: 100W RMS into 8-ohm  
125W RMS into 4-ohm
- Frequency response: 10Hz-100KHz
- T.H.D.: less than 0.008%
- S/N ratio: better than 80dB
- Input sensitivity: 1V max.
- Power supply:  $\pm 40V$  @ 5 amp
- One channel, needs two for stereo

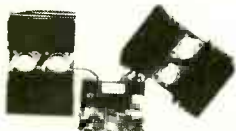

**TA-1000KIT**  
**\$51.95**  
Power transformer  
**\$24.00 each**

**50 WATTS AUTO STEREO BOOSTER BY VERTRONIX**

Specifications: • 50 watts RMS total (25W + 25W)



Model V-Amp 500  
**REG. PRICE \$119.00 EACH**  
**OUR SPECIAL PRICE \$55.00 EACH**

- Frequency Response:  $\pm 0.5dB$ , 20Hz ~ 20KHz
- T.H.D. 0.2% at full rated output
- Input Impedance: 20K ohms
- Crosstalk: Better than 90dB
- Sensitivity: 15V for full rated output
- S/N Ratio: Greater than 95dB
- Speaker Load: 2 ~ 8 ohms
- Voltage Supply 9~18VDC.

**"FISHER" 30 WATT STEREO AMP MAIN AMP (15W x 2)**



**Super Buy**  
**Only \$18.50**

Kit includes 2 pcs. Fisher PA 301 Hybrid IC all electronic parts with PC Board. Power supply  $\pm 16V$  DC (not included). Power band with (KF 1%  $\pm 3dB$ ) Voltage gain 33dB. 20Hz-20KHz.

**5W AUDIO AMP KIT**



2 LM 380 with Volume Control  
Power Supply 6 ~ 18V DC  
**ONLY \$6.00 EACH**

**2 WATT AUDIO AMP**

Pre assembled units. All you need is to hook up the speaker and the volume control. Supply voltage from 9~15V D.C. measures only 2" x 3 1/2", making it good for portable or discrete applications. Comes with hook up data.



**BUY 2 FOR \$4.99**

**1 WATT AUDIO AMP**

All parts are pre-assembled on a mini PC Board. Supply Voltage 6~9V D.C.  
**SPECIAL PRICE \$1.95 ea.**

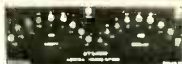

**NEW MARK III 9 Steps 4 Colors LED VU**

Stereo level indicator kit with arc-shape display panel!!! This Mark III LED level indicator is a new design PC board with an arc-shape 4 colors LED display (change color from red, yellow, green and the peak output indicated by rose). The power range is very large from -30dB to +5dB. The Mark III indicator is applicable to 1 watt - 200 watts amplifier operating voltage is 3V-9V DC at max 400 MA. The circuit uses 10 LEDs per channel. It is very easy to connect to the amplifier. Just hook up with the speaker output!

**IN KIT FORM \$18.50**

**MARK IV 15 STEPS LED POWER LEVEL INDICATOR KIT**

This new stereo level indicator kit consists of 36 4-color LED (15 per channel) to indicate the sound level output of your amplifier from -36dB +3dB. Comes with a well-designed silk screen printed plastic panel and has a selector switch to allow floating or gradual output indicating. Power supply is 6 ~ 12V D.C. with THG on board input sensitivity controls. This unit can work with any amplifier from 1W to 200W! Kit includes 70 pcs. driver transistors, 38 pcs. matched 4-color LED, all other electronic components, PC board and front panel.



**MARK IV KIT \$31.50**

**MARK V 15 STEPS LED POWER OUTPUT INDICATOR KIT**

All functions same as Mark IV but this is with heavy duty aluminum front plate and case. Can be easily slot into the front panel of your auto, truck or boat. Operates on 12V DC.



**\$41.50 EACH KIT**

**SOLID STATE STEREO GRAPHIC EQUALIZER PRE AMP KIT TA-2500**

Specifications:  
• Total Harmonic Distortion: Less than 0.05%  
• Intermodulation Distortion: (70Hz:7KHz = 4:1 SMPTE Method) Less than 0.03%  
• Frequency Response: Overall 10Hz ~ 100KHz  $\pm 0.5dB$ , -1dB.  
• RIAA Curve Deviation: (Phono) +0.2dB, -0.2dB (30Hz ~ 15KHz)  
• Channel separation (at rated output 1KHz)  
• Phono, Tuner, Aux and Tape Monitor better than 70dB.  
• Input sensitivity and impedance (1KHz for rated output) Phono: 2MV 47K ohms Aux: 130MV 50K ohms Tuner: 130MV 50K ohms Tape: 130MV 50K ohms  
• Graphic Equalizer control: 10 Band Slide Control  
• Frequency Bands: 31 5Hz: G3Hz: 125Hz: 250Hz: 500Hz: 1KHz: 2KHz: 4KHz: 8KHz: 16KHz also with on panel selector for Phono, Tuner, Aux 1 and Aux 2.  
• Power Supply: 117 VAC  
Kit comes with all electronic components, transformer, instructions and a 19" rack mount type metal cabinet.



**MODEL TA-2500 \$119.00 PER KIT**

**ELECTRONIC DUAL SPEAKER PROTECTOR**



Cut off when circuit is shorted or over load to protect your amplifier as well as your speakers. A must for OCL circuits.

**KIT FORM \$8.75 EA.**

**PROFESSIONAL REGULATED VARIABLE D.C. POWER SUPPLY KIT**

All solid state circuitry with high efficiency power transistor 2SD388 and I.C. voltage regulator MC1733. Output voltage can be adjusted from 0-30V at 1 amp current limited or 0-15V at 2 amp current limited. Internal resistance is less than 0.005 ohm; ripple and noise less than 1 MV. dual on panel meter for voltage and amp reading, also with on board LED and audible over load indicator. Kit comes with predrilled P.C. board, instructions, all necessary electronic components, transformer and a professional look metal cabinet. The best project for school and the most useful instrument for repairman. Build one today!  
**MODEL TR 88A 0 ~ 15V D.C. 2 amp**  
**MODEL TR 88B 0 ~ 30V D.C. 1 amp**

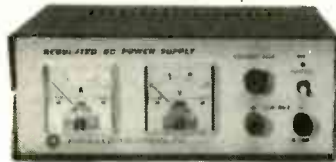

**\$59.50 PER KIT**

**REGULATED DUAL VOLTAGE SUPPLY KIT**

$\pm 4$  ~ 30V DC 800 MA adjustable, fully regulated by Fairchild 78MG and 79MG voltage regulator I.C. Kit includes all electronic parts, filter capacitors, I.C. heat sinks and P.C. board.



**\$12.50 PER KIT**

**POWER SUPPLY KIT**

0-30V D.C. REGULATED  
Uses UA723 and ZN3055 Power TR output can be adjusted from 0-30V, 2 AMP. Complete with PC board and all electronic parts. Transformer for Power Supply, 2 AMP 24V x 2 **\$9.50**



0-30 Power Supply  
**\$10.50 each**

**TA-323 6 WATTS TOTAL 30W + 30W STEREO AMP KIT**

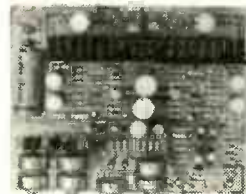

**★ SPECIAL ★**

**EXCELLENT PRICE!**

**MODEL 001-0034**  
Transformer (Optional)

This is a solid state all transistor circuitry with on board stereo pre-amp for most microphone or phone input. Power output employs 2 pairs matching Darlingtons Transistors. Driven by the popular 2N3053 Driver Transistors. Four built on board controls for; volume, balance, treble and bass. Power supplies requires 48 VET 2.5 amp transformer. T.H.D. of less than 0.1% between 100 Hz and 10KHz at full power. (30 Watts + 30 Watts loaded by 8~).

**\$29.50 PER KIT \$10.50 EACH**

**POCKET STEREO CASSETTE PLAYER WITH STEREO HEAD PHONE**



This unit is a high fidelity stereo player which will give you years of listening pleasure and follow you wherever you go. Made by the same company in Japan who use the "Big Name."

Complete set comes with 1 Stereo head-phone, 3 AA size alkaline batteries, 1 leather like carrying case for player and 1 carrying case for storage of 4 cassette tapes and 1 demo tape.

**MODEL SWM-33**  
**OUR DIRECT IMPORT PRICE**

**\$67.50**



**FORMULA INTERNATIONAL INC.**

3/82

|   | SHIPPING AND HANDLING CHARGES |                       |
|---|-------------------------------|-----------------------|
|   | Under \$50.00 purchase        | Over \$50.00 purchase |
| Inside California                         | 10%                           | 5%                    |
| Outside Calif. (includes Mexico & Canada) | 15%                           | 10%                   |
| Overseas                                  | 25%                           | 20%                   |

Minimum Order \$10.00/Canit. Residents Add 6% Sales Tax. Phone Orders Accepted on Visa or MC ONLY. NO C.O.D. (Store Hours 10-7 Mon-Thu Sat)

12603 CRENSHAW BLVD., HAWTHORNE, CA 90250  
PHONE: (213) 973-1921 • (213) 679-5162

Send \$1.00 For Detailed Catalogue





**FOR COMMERCIAL FREE TV BOX BUILDERS**

|                 |         |                      |         |
|-----------------|---------|----------------------|---------|
| MC 1358         | \$2.50  | LM 7815              | \$1.20  |
| MC 1350         | \$2.00  | NE 565               | \$2.00  |
| MC 1330         | \$3.00  | Connectors Set       | \$1.00  |
| LM 1458         | \$1.00  | I.C. Socket Set      | \$2.00  |
| LM 380          | \$2.00  | Matching Transformer | \$1.40  |
| Sanyo UHF Tuner | \$35.00 | Tolrid Coils         |         |
| Capacitors Set  | \$12.50 | (Set of 4)           | \$3.00  |
| Resistors Set   | \$2.00  | Speaker Cabinet      | \$12.95 |
| Trim Pots       |         | Transformer          |         |
| Trim Caps Set   | \$13.50 | 18V 800MA            | \$3.00  |
| Pots and Knobs  | \$2.00  |                      |         |

We sell you all the above components in a package for **\$125.00** and you will receive a free predrilled P.C. board and instructions at no charge!

**SANYO UHF VARACTOR TUNER**

For UHF CH 14 83  
Tuning voltage +1V~+28V D.C. Input impedance 75 OHM. I.F. band width 7~16 MHz. Noise figure 11.5dB MAX. Size 2 3/4" x 1 1/4" x 3/4". Supply voltage 15V D.C. Sound I.F. = 58.0 MHz. Video I.F. = 62.5 MHz.



All units are brand new from Sanyo.  
**MODEL 115-B-405A**  
**\$35.00 EACH**

Tuner is the most important part for the circuit. Don't let those \$19.00 tuners fool you!

**TV GAME BOARD**

PLAYS 4 GAMES: TENNIS, HOCKEY, HANDBALL AND JAI-ALAI.

All boards complete with all parts ready to play. Requires 6C size batteries and a small speaker for sound effects. The boards were surplus from a famous game manufacturer. They will play on all US standard black and white or color TV sets. (Regular price for these games were \$39.50 each)

**OUR PRICE ONLY \$6.50 EACH**

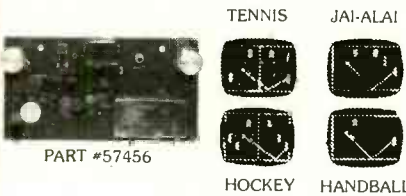

PART #57456

TENNIS JAI-ALAI  
HOCKEY HANDBALL

**ELECTRONIC PIN BALL MACHINE**



That sounds and plays like the real thing. All units are brand new but without the case. Functions of the game include double flipper control, klicker control, 1-4 players, 3 speed ball control, tilt switch, automatic score, extra bonus cave and many more. All solid state with LED panel, no moving parts. Requires 9V battery to operate, speaker not included.

A perfect gift for yourself or friends.

**SPECIAL \$8.99 EACH SPEAKER \$1.25 EACH**

**ELECTRONIC MUSICAL TELEPHONE REST KIT**

This telephone rest can be used as a door charm, an audible indicator and for many other sound projects. The special custom made I.C. is pre programmed with 4 musical tunes. Kit comes with a nice looking plastic case, pre-drilled P.C. board, volume control, special sound I.C. speakers and all electronic components and instructions. Ideal for home or school projects.



MODEL FIH-3000

**BUY NOW!**

**SPECIAL PRICE! ONLY**

**\$15.50 PER KIT**

**DIGITAL TIMER/CLOCK**

- 24 Hour preset time to turn on or off
- 12 Hour green 0.5" display for time
- operated on 12~16V A.C.

The whole timer is self contained in a compact plastic case (as seen in photo). Designed for VTR with push button switch for easy setting. Limited quantity available.



**NOW ONLY \$12.94 MODEL VEQ 0143**

**SANYO ANTENNA SIGNAL BOOSTER**

This Booster is specially designed for UHF Channels (14-83). After installed this unit (between the antenna input cable and the UHF tuner) will have a minimum of 10dB gain, that is approximately 2 times better than what you are seeing now. Ideal for those who live in apartments that cannot put up an outdoor antenna. Size is so small; only 2" x 1 1/2" x 1". Supply voltage is 15 VDC.



**★ NEW ITEM ★**

MODEL 001-0076

**\$12.50 EACH**

**13 FUNCTIONS LCD TIME MODULE**



MODEL 001-0062

**\$7.94 EACH**

- Displays month, date and day of the week
- Displays hour, minute and second
- AM, PM Indicator
- Alarm 1 and Alarm 2 (Independent)
- 10 Hours Stop Watch
- 12 Hours presettable count down time
- Hour Charm Indicator
- Back light by touch of the switch

These modules are brand new and made by LITRONIX. Designed for a man's watch. Can be used for many applications. Comes with 2 silver batteries and the ceramic round transducer.

**MATCHED PAIR POWER TRANSISTORS BY MOTOROLA**

|                       |           |                |
|-----------------------|-----------|----------------|
| MJ2955 PNP 150 Watts  | BV=60 V   | <b>\$3.50</b>  |
| 2N3055 NPN            | I.C.=15 A | per pair       |
| MJE2955 PNP 90 Watts  | BV=60 V   | <b>\$3.00</b>  |
| MJE3055 NPN           | I.C.=10 A | per pair       |
| MJ15003 NPN 250 Watts | BV=140 V  | <b>\$12.00</b> |
| MJ15004 PNP           | I.C.=20 A | per pair       |

All above parts guaranteed to be prime and come with data sheets.

**MUFFIN FANS FOR EQUIPMENT COOLING**



These fans are pulled out from used computers. But carefully cleaned by ultrasonic cleaner. All in "like-new" condition. Size 4 11/16" x 1-1/2" x 4 11/16"  
MODEL MF505  
**\$9.50 EACH**

**FLUORESCENT LIGHT DRIVER KIT**



12V DC POWERED  
Lights up 8~15 Watt Fluorescent Light Tubes. Ideal for camper, outdoor, auto or boat Kit includes high voltage coil, power transistor, heat sink, all other electronic parts and PC Board. light tube not included!

**\$6.50 Per Kit**

**PRESS-A-LIGHT SELF GENERATED FLASHLIGHT**

Never worry about battery, EXCLUSIVE! **\$3.95 ea.** because it has none! Easy to carry in pocket and handy to use. Ideal for emergency light. It generates its own electricity by squeezing grip lever. Put one in your car, boat, camper or home. You may need it some time!



Model F-179

**CRYSTAL CONTROLLED WIRELESS MICROPHONE SYSTEM**

No FCC license required  
**OUR PRICE \$49.50**  
ADDITIONAL MICROPHONE (TRANSMITTER) AVAILABLE AT **\$28.00 EACH**



MURA WMS-49

Transmitter: FET mic for flat 30 ~18 KHz response extra controlled 49MHz AM Band for drift-free performance. 100 MW output (range approx. 1/4 mile) for reliable long range transmission. Powered by a 9V radio battery (included).  
Receiver: Extra controlled locks on 49MHz transmitter signal. With on panel VU meter

**SUPER FM WIRELESS MIC KIT—MARK III**

This new designed circuit uses high FEQ. FET transistors with 2 stages pre amp. Transmits FM Range (88-120 MHz) up to 2 blocks away and with the ultra sensitive condenser microphone that comes with the kit, allows you to pick up any sound within 15 ft. away! Kit includes all electronic parts, OSC coils, and P.C. Board. Power supply 9V D.C.

FMC-105

**\$11.50 PER KIT**

**WEM-36 FM WIRELESS MICROPHONE**

TEET MODEL WEM-36 is a factory assembled FM wireless microphone powered by two AA size batteries. Transmits in the range of 88-108 MHz with 3 transistor circuits to meet with F.C.C. part 15 regulations. Element is built in a plastic tube type case with an omni-directional electret condenser microphone unit. By using a standard FM radio, signal can be heard anywhere on a one-acre lot. Sound quality was judged "very good."

MODEL WEM-36

**\$16.50 EACH**

**WHISTLE ACTIVATED SWITCH BOARD**

All boards are pre-assembled and tested. Your whistle to its FET condenser microphone from a distance, as far as 30 feet away (sensitivity can be easily adjusted) will turn the switch on, then match your whistle to it again, then it turns off. Ideal for remote control toys, electrical appliance such as lights, coffee pots, TV, Hi-Fi, radio or other projects. Unit works on 9V D.C.



MODEL 968

**\$4.50 EACH**

**ULTRASONIC SWITCH KIT**

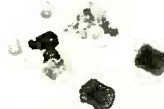

Kit includes the Ultra Sonic Transducers, 2 PC Boards for transmitter and receiver. All electronic parts and instructions. Easy to build and a lot of uses such as remote control for TV, garage door, alarm system or counter. Unit operates by 9-12 DC.

**\$15.50**

**ELECTRONIC SWITCH KIT**

CONDENSER TYPE  
Touch On Touch Off  
uses 7473 I.C. and  
12V relay

**\$5.50 each**



**FORMULA INTERNATIONAL INC.**

3/82

|   | SHIPPING AND HANDLING CHARGES |                       |
|---|-------------------------------|-----------------------|
|   | Under \$50.00 purchase        | Over \$50.00 purchase |
| Inside California                         | 10%                           | 5%                    |
| Outside Calif. (includes Mexico & Canada) | 15%                           | 10%                   |
| Overseas                                  | 25%                           | 20%                   |

Minimum Order \$10.00/Calif Residents Add 6% Sales Tax  
Phone Orders Accepted on Visa or MC ONLY. NO C.O.D./Store Hours 10-7 Mon-Thu Sat

12603 CRENSHAW BLVD., HAWTHORNE, CA 90250  
PHONE: (213) 973-1921 • (213) 679-5162

Send \$1.00 For Detailed Catalogue



**MICRO-VIDEO II**

Cable T.V. Decoders  
In Stock

**Complete Satellite Systems**

- Micro-Wave T.V. System
- Precision Parabolic Antenna
- Advanced Down Converter
- Power Supply
- Low-Loss Coaxial Cables
- Complete - Ready To Install

Call Toll-Free 1-800-626-5533

**SOUND & VIDEO RESEARCH**  
P.O. Box 19462  
Louisville, KY 40219

\$169.95

**39.95**  
ADD \$2.50 FOR POSTAGE

**30 CHANNEL CABLE TV CONVERTER**

ORDER No. 171AE047

**ELCO** ROUTE 9N,  
PLATTSBURGH, N.Y. 12901  
Tel.: (518) 561-8700.

**FREE!**  
UNUSUAL 96 PAGE  
ELECTRONIC PARTS  
& IDEAS CATALOG!

**USO**

**"In Harmony"**

You know harmony means more than just entertainment at the USO. It's volunteers working together to create a "back home" environment for servicemen and women stationed far from home. It's Informal classes...inter-cultural understanding...and orientation information. USO...It's sweet music.

*Dixie Humming Birds*

Support USO through the United Way, OCF, or local USO campaign

**AMAZING DEVICES**

**PHASORS/SHOCKWAVE**

PPF-1 PHASOR PAIN FIELD — Is being tested by Gov't for riot control. Soon to come under weapons restrictions as an internal machine. Easily hand-held. Hazardous — Use with discretion. SOLD ONLY FOR ANIMAL CONTROL.

PPF-1 PLANS \$15.00

IPG-3 INVISIBLE PAIN FIELD GENERATOR — Produces directional field of moderately intense pain to lower back of head up to 50 ft. Cigarette pack sized enclosure is easily hidden.

IPG-3 PLANS \$7.00 IPG-3K KIT \$39.50

IPG-30 ASSEMBLED FOR ANIMAL CONTROL \$49.50

HUG-1 HIGH POWERED ULTRASONIC GUN — Produces directional 130 db's of sound pressure energy at 20-24 KHZ. Hand-held, intended for lab use.

HUG-1 PLANS \$10.00

**LASERS**

PARTICLE BEAM WEAPON PLANS \$15.00

LHP-2 BEGINNER VISIBLE RED NON-HAZARDOUS OPTICAL DEVICE. Adjustable pulse.

LHP-2 PLANS \$7.00 LHP-2K KIT \$39.50

LP-3/LRG-3 LASER PISTOL AND RIFLE COMBINATION — 7-24 watts of infrared energy.

LP-3/LRG-3 PLANS \$10.00

LGU-1 VISIBLE RED LASER GUN for holography, special effects, cloud writing, etc.

LGU-1 PLANS \$10.00

LC-1 BURNING/CUTTING CO2 LASER — 10-40 watts continuous.

LC-1 PLANS \$15.00

RUB-1 WELDING/DRILLING RUBY/YAG LASER, intense red.

RUB-1 PLANS \$15.00

HPS-1 HIGH POWERED PORTABLE ENERGY SOURCE FOR LASERS & MAGNETIC WEAPONS exploding wires, shock waves, etc.

HPS-1 PLANS \$8.00 HPS-1K KIT \$49.50

**SECURITY/PERSONAL PROTECTION**

INF-1 INFINITY TRANSMITTER — Uses telephone lines for selective home or office listening while away on business or vacation.

INF-1 PLANS \$15.00

SD-4 SEE IN THE DARK — Device, long range SD-4 PLANS \$10.00

VWPM-5 WIRELESS TELEPHONE TRANSMITTER — Long range.

VWPM-5 PLANS \$10.00 VWPM-5K KIT \$34.50

FBT-7 WIRELESS MICROPHONE — Extended range.

FBT-7 PLANS \$7.00 FBT-7K KIT \$34.50

HOD-1/TT-6 ELECTRONIC TRACKING AND HOMING DEVICE —

HOD-1/TT-6 PLANS \$6.00 HOD-1K/TT-6K KIT \$39.50

TAT-2 TALK AND TELL — Records receive telephone when in use.

TAT-2 PLANS \$5.00 TAT-2K KIT \$14.50

PSW-3 PHASOR STUN WAND — Produces energy capable of burning flesh. Intended as a last resort personal defense weapon.

PSW-3 PLANS \$8.00 PSW-3K KIT \$59.50

Send for free catalog descriptions of above items, kits and parts, plus hundreds more. We accept Master Charge and VISA or when ordering send check or money order to:

**SCIENTIFIC SYSTEMS**  
DEPT. RB BOX 716, AMHERST N.H. 03031

**Westland Electronics**  
INCORPORATED

**Memory**

|                               |                    |
|-------------------------------|--------------------|
| 4116-250nS                    | 8/14.95            |
| 4116-200nS                    | 8/17.95            |
| 4164-200nS                    | 17.95 ea. 8/128.00 |
| 2114L                         | 8/17.95            |
| 6116 2K x 8 CMOS RAM 200nS    | 13.95              |
| 2708 EPROM                    | 3.49               |
| 2716 EPROM                    | 5.49               |
| 2732 EPROM                    | 12.99              |
| 2764 EPROM                    | 34.95              |
| Z6132 4K x 8 Quasi-Static RAM | 24.95              |

**Microprocessor & Interface**

|         |       |           |       |           |       |
|---------|-------|-----------|-------|-----------|-------|
| 1771    | 24.50 | 6845      | 18.49 | DAC-0800  | 3.99  |
| 1791    | 34.95 | 6850      | 4.49  | INS8250   | 14.90 |
| 21102   | 1.49  | 8085A     | 8.95  | MMS1617   | 8.75  |
| 2112    | 2.39  | 8212      | 2.75  | TMS9900   | 29.95 |
| 2516    | 5.49  | 8214      | 3.95  | TR1602B   | 2.49  |
| 2532    | 12.99 | 8216      | 2.75  | SC-01     | 55.00 |
| 2651    | 12.95 | 8224      | 3.29  | Z80A-CPU  | 7.95  |
| 4044L-2 | 2.49  | 8226      | 2.79  | Z80ACCTC  | 7.49  |
| 6502    | 8.99  | 8228      | 4.49  | Z80ADart. | 19.95 |
| 6800    | 6.99  | 8251      | 6.95  | Z80APIO   | 7.49  |
| 6802    | 11.95 | 8255      | 6.49  | Z80ASIO   | 17.95 |
| 6809    | 19.95 | AY5-1013A | 4.95  | Z8B03     | 74.95 |
| 6821    | 4.95  | AY5-2376  | 14.95 | Z8B71     | 29.95 |

**1 Amp TO-220 Voltage Regulators**

| PART #           | 1-24 | 25-99 | 100-499 |
|------------------|------|-------|---------|
| 7805 (LM340T-5)  | .85  | .75   | .65     |
| 7812 (LM340T-12) | .85  | .75   | .65     |
| 7815 (LM340T-15) | .85  | .75   | .65     |
| 7818 (LM340T-18) | .85  | .75   | .65     |

**Linear Integrated Circuits**

|           |      |          |      |         |      |
|-----------|------|----------|------|---------|------|
| 8038      | 3.95 | LM393    | 97   | MC3302  | 90   |
| LF351     | 75   | LM733    | 99   | MC1458  | 59   |
| LF353     | 1.29 | LM741-8  | 35   | MC1514  | 1.39 |
| LF357     | 1.39 | LM741-14 | 35   | NE555   | 45   |
| LM301     | 45   | LM747    | 77   | NE556   | 98   |
| LM307     | 49   | LM748    | 49   | NE565   | 1.25 |
| LM311     | 95   | LM1310   | 2.49 | NE5534  | 2.35 |
| LM318     | 1.75 | LM1458   | 69   | NE5538  | 2.25 |
| LM324     | 90   | LM1800   | 2.49 | SSM2010 | 7.50 |
| LM339     | 79   | LM1818   | 3.49 | SSM2020 | 7.50 |
| LM358     | 90   | LM1889   | 2.99 | SSM2030 | 7.50 |
| LM377     | 2.49 | LM2900   | 69   | SSM2040 | 7.50 |
| LM380N-14 | 1.25 | LM3900   | 89   | SSM2044 | 5.75 |
| LM381     | 1.89 | LM3905   | 1.49 | SSM2055 | 6.50 |
| LM383     | 3.29 | LM3914   | 3.79 | XR2206  | 5.19 |
| LM384     | 1.95 | LM3915   | 3.79 | XR4136  | 99   |
| LM386     | 99   | LM3916   | 3.79 | XR4741  | 1.95 |
| LM387     | 1.49 | LM4500   | 3.29 | XR558   | 1.99 |

**5% Carbon Film Resistors**  
We stock all 5% standard values between 1 Ohm and 1 Meg Ohm.

**¼ Watt**

|                             |       |
|-----------------------------|-------|
| Package of 5                | 20    |
| Package of 100 (one value)  | 1.65  |
| Package of 1000 (one value) | 12.00 |

**½ Watt**

|                             |       |
|-----------------------------|-------|
| Package of 5                | .25   |
| Package of 100 (one value)  | 1.75  |
| Package of 1000 (one value) | 15.00 |

Sampler box consisting of 5 each of all 145 standard 5% values between 1 Ohm and 1 Meg Ohm.

¼ Watt Sampler Box 22.00  
½ Watt Sampler Box 27.00

Minimum Order \$10.00

Shipping

|          |      |             |          |
|----------|------|-------------|----------|
| 10-24.99 | 3.00 | Above 50.00 | FREE     |
| 25-49.99 | 1.50 | C.O.D.      | Add 1.65 |

**WESTLAND ELECTRONICS**  
37387 Ford Rd. • Westland, Mi 48185  
Order Line - 1-800-521-0664  
In Michigan - 313-728-0650

**TRI-TEK**

LO PROFILE DUAL BEAM  
FACE WIPE (TIN) SOCKETS

|           |      |       |         |        |
|-----------|------|-------|---------|--------|
|           | 1-24 | 25-99 | 100-499 | 500 up |
| 6 PIN LP  | .08  | .075  | .070    | .060   |
| 8 PIN LP  | .09  | .085  | .079    | .065   |
| 14 PIN LP | .15  | .135  | .120    | .112   |
| 16 PIN LP | .17  | .150  | .135    | .128   |
| 18 PIN LP | .19  | .170  | .150    | .144   |
| 20 PIN LP | .22  | .195  | .170    | .160   |
| 22 PIN LP | .25  | .230  | .210    | .178   |
| 24 PIN LP | .26  | .240  | .220    | .195   |
| 28 PIN LP | .31  | .290  | .270    | .228   |
| 40 PIN LP | .44  | .415  | .370    | .325   |

**3 LEVEL WIRE WRAP DIP SOCKETS (TIN)**

|            |      |       |         |        |
|------------|------|-------|---------|--------|
|            | 1-24 | 25-99 | 100-499 | 500 up |
| 8 PIN WWT  | .33  | .31   | .290    | .270   |
| 14 PIN WWT | .38  | .36   | .330    | .320   |
| 16 PIN WWT | .42  | .39   | .370    | .360   |
| 18 PIN WWT | .58  | .55   | .515    | .471   |
| 20 PIN WWT | .63  | .64   | .704    | .620   |
| 24 PIN WWT | .81  | .77   | .726    | .662   |
| 28 PIN WWT | .93  | .87   | .882    | .798   |
| 40 PIN WWT | 1.27 | 1.20  | 1.136   | 1.092  |

**D Subminiature Connectors — Compare These Prices!!**

| PLUGS   | 1-24   | 25-99  | SOCKETS | 1-9     | 10-24  | 25-99  |
|---------|--------|--------|---------|---------|--------|--------|
| (DE) 9P | \$1.95 | \$1.75 | \$1.60  | (DE) 9S | \$3.10 | \$2.75 |
| (DA)15P | 2.35   | 2.10   | 1.90    | (DA)15S | 4.20   | 3.75   |
| (DB)25P | 2.60   | 2.35   | 2.15    | (DB)25S | 3.30   | 3.45   |
| (DC)37P | 4.55   | 4.15   | 3.80    | (DC)37S | 8.85   | 8.00   |
| (DD)50P | 5.65   | 5.15   | 4.65    | (DD)50S | 11.65  | 10.60  |

DB 51226 Cover For DB 25P and S (RS 232 Type) \$1.39

**CYBERTONE** like a super loud SONALERT this "warming" alarm works from 9-12VDC and has variable rate and pitch. Ideal for smoke or burglar alarms or far-out games. Only 1 1/4" diameter, 6" long leads. Model CT-1100. \$7.95

**25 Amp STUD DIODES 200V**.....59¢ 600V.....79¢  
200 ohm Carbon mike element 1/4" diameter.....96¢  
Miniature 600—600ma modern transformer.....\$1.49  
6 foot 3 wire Grey line cord. Rt angle plug.....\$1.69

**JOHNSON 1/4" BUSHING Air Variable Capacitors**.....49¢  
#189-567 2.19/3pf, #189-563 1.4-9.2pf, #100-107 1.2-3-14.2pf

**Calendar/Clock Chip and Vacuum-Fluorescent Display.**  
Mostek MK50362-N, 20 pin clock/calendar I.C. with a FUTABA 5-LT-02-8G V.F. display and spec sheets, 1/2" high characters, AM/PM indicators, color. Blue-green color ideal for daylight operation. \$5.98/set

6 digit L.E.D. display.....65" common cathode.....\$3.98  
FND 503.....85" FND507.....\$1.49 MAN6710 (DUAL).....\$1.98  
Switch Craft 142A miniature "TINI-D" phone jack.....49¢  
Line master chrome foot switch SPOT 6 cord KGM-36.....\$4.98  
Line master black foot switch SPOT 5 AMQ-F-51-S.....\$2.98  
Cherry E-53 Super Sensitive snap switch SPOT.....\$21.00  
C&K DPDT 1/4" toggle switch w/flat designer handle #1.....98¢

**MOOSE™ National Semi LM 396 Regulator** adjustable from 1.25-15V at 10 Amp. w/specs.....\$19.95

**Super Cap. 1 FARAD at 5V.** Use as memory supply back-up. Only 1 1/4" dia. x 1/4" tall w/P.C. leads.....\$10.50

**R/C transmitter/receiver chip set.** National LM1871/72 has RF & Encode/Decode up to 6 channels of digital or analog link. With specs.....\$15.95/set

100V 25 Amp Bridge Rectifier (Rem. from Eq.).....\$1.79  
400V 4 Amp TRIAC w/Heat Sink RCA 40S036.....69¢  
400V 35 Amp Q mode TRIAC (isolate).....\$1.99  
80V 5A Darlingon TIP121 in TO-220 package.....99¢  
200V 4A TO-202 TRIAC Q 2004F3.....59¢

**TRI-TEK**

**7808 N. 27th Avenue  
Phoenix, Arizona 85021**

ORDER TOLL FREE: 1-800-528-0183  
(Order desk only)

TERMS: \$10.00 minimum order.  
Visa, MC, BAC, Check, M.O. or UPS C.O.D.  
U.S. Funds only. AZ residents add 5% sales tax.  
Prepaid orders over \$50 shipping prepaid.

OTHERS: Add \$3.00 shipping & handling.  
Add \$1.50 for C.O.D. orders.  
Outside U.S., add 20%.



# Make Radio Shack Your Parts Place

## No Waiting! No Minimum Order! Low Prices!

### Check These Test Equipment Values

#### Transistor Checker

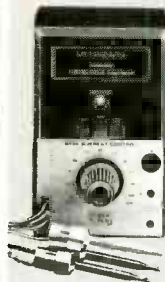

**NEW!**

Tests In  
Or Out  
Of Circuit

Only

**1495**

Indicates "opens," "shorts," and relative current gain in PNP and NPN small-signal and power types. Socket, plus mini hook clips for in-circuit tests. Output for meter or scope, too. Requires "AA" battery. A timesaver!  
22-025 ..... 14.95

#### Our Best Analog VOM



- 43 Ranges!
- 4 1/4" Scale

**38% Off**

Reg.  
39.95

**2488**

Buy now and save \$15.07 on this Micronta® multitester with voltage and current Range-Doubler switch for extra precision. Requires "AA" and 9V batteries. With leads, instructions.  
22-204 ..... Sale 24.88  
Sale Begins 2/23/82. Ends 3/28/82.

### Handheld Enclosure



**395**

For meters, remote controllers, T-pads, more. Has compartment for 9V battery. Polystyrene. 1 1/2 x 3 1/2 x 5 3/4".  
270-219 ..... 3.95

### Solid Buss Wire

**149**



Fifty feet of pretinned 24-ga. copper on a spool. Ideal for perboard and printed circuit projects. 278-1341 ..... 1.49

### Prime CMOS ICs

Low As **79¢**



| Device | Cat. No. | Each |
|--------|----------|------|
| 4001   | 276-2401 | .79  |
| 4011   | 276-2411 | .79  |
| 4013   | 276-2413 | .99  |
| 4017   | 276-2417 | 1.69 |
| 4027   | 276-2427 | 1.19 |
| 4042   | 276-2442 | 1.29 |
| 4049   | 276-2449 | .99  |
| 4050   | 276-2450 | .99  |
| 4066   | 276-2466 | 1.19 |
| 4070   | 276-2470 | .99  |
| 4081   | 276-2481 | .89  |
| 4511   | 276-2447 | 1.99 |
| 4528   | 276-2496 | 1.49 |
| 4553   | 276-2498 | 3.59 |



### Crystal Mike Element

Multipurpose high-impedance element with 50-8000 Hz response and leads for easy hookup.  
270-095 ..... 1.59

**159**

### Electrolytic Kit



**595**

Set of 16

• 35VWDC • Radial Leads  
Three 4.7, 10, 47 uF; two 22, 100 uF; one 220, 470 and 1000 uF. In reusable box with hanger. 272-605 ..... Set 5.95

### Magnet Wire

**449**

Set Of 3



Ideal for winding coils. 40 ft. of 22-ga., 75 ft. of 26-ga., 200 ft. of 30 ga.  
278-1345 ..... Set 4.49

### 20-Amp DPDT Switch

**279**



Momentary Type. With spring return to center position. Rated 20 amps at 12VDC. Mounts in 7/16" hole. 275-709 ..... 2.79

### Let's Wrap!



A Wire-Wrapping Tool. 4 1/2" long. metal. 276-1570 ..... 5.95

B 30-Gauge Kynar Wire. 50-foot spools. Choice of colors ..... Each, 2.39

|      |          |        |          |
|------|----------|--------|----------|
| Red  | #278-501 | White  | #278-502 |
| Blue | #278-503 | Yellow | #278-504 |

### Piezo Buzzer

**299**



For 1.5 to 20VDC  
Loud 4.8 kHz signal gets attention. Ideal for battery-powered circuits—draws just 12 milliamps at 9VDC. 1 1/2 x 3/8" With leads. 273-060 ..... 2.99



### Touch-Tone\* Pad

Ideal for remote control, ham radio autopatching, phone upgrading and more. Top quality!  
277-1010 ..... 16.95

\*Trademark of AT&T

### DPST Reed Relay

Only **99¢**



5VDC, 180-Ohm Coll. Contacts rated 0.5 amp at 120VAC. PC mountable.  
275-228 ..... 99¢

### "Analog/Digital" ICs

Low As **259**



TL507. A to D chip converts analog processes to the signals required for microprocessor controlling—up to 1000 operations per second! Single supply. 8-pin DIP with ap notes.  
276-1789 ..... 2.59

DAC801. D to A IC gives you an analog output up to 20 volts peak-to-peak with 8-bit digital input. Interfaces with all popular logic families. Low power consumption. 16-pin DIP with data.  
276-1791 ..... 4.49

9400. A highly linear frequency-to-voltage/voltage-to-frequency converter that operates up to 100 kHz. Ideal for modems. Single or split supply. 14-pin DIP with data. 276-1790 ..... 3.49

### Red Mini Lamps



5-Inch Leads **99¢**  
Pkg. of 6

Cute incandescents for dial lights, model RRs, winks-blinkens and more. 6V at 60 milliamps.  
272-1144 ..... Pkg. of 6/99¢

### Phono Jack Board



**119**

Chassis-mount phenolic board with eight RCA-type jacks. Excellent for audio "patch bays." 274-370 ..... 1.19

### Text/Tape Electronics Course

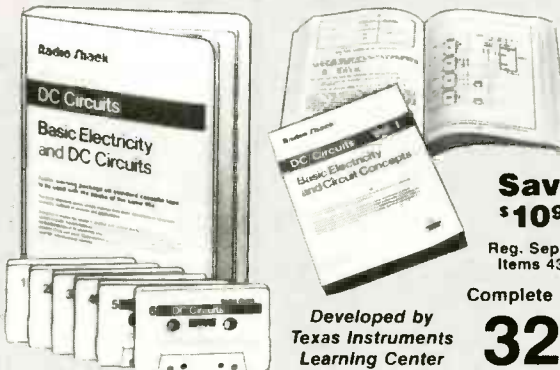

Save **\$1090**

Reg. Separate Items 43.85

Complete Course

**3295**

Developed by Texas Instruments Learning Center

DC Circuits Volume I. An easy-to-understand introduction to electricity, voltage, current, Ohm's law, parallel circuits and more. Fully illustrated. 480 pages. 62-2019 ..... Separately, 6.95  
DC Circuits Volume II. Covers voltage dividers, capacitors, inductors, formulas and more. Illustrated. 508 pages. 62-2020 ..... Separately, 6.95  
DC Circuits Audio Learning Package. Six standard cassettes that reinforce the concepts presented in Volumes I and II. Learn electronics fundamentals at your own pace! 62-2401 ..... Separately, 29.95

An American Electronics Tradition  
For Over Sixty-One Years!

Prices may vary at individual stores and dealers

**Radio Shack**

A DIVISION OF TANDY CORPORATION  
OVER 8200 LOCATIONS IN 76 COUNTRIES

CIRCLE 5 ON FREE INFORMATION CARD

# ETCO

## CABLE TV CONVERTERS AND OTHER GOOD STUFF!

SMASHING ALL SALES RECORDS - OUR NEW 30 CHANNEL CABLE TV CONVERTER!



Converts mid & super band cable channels for viewing on your TV set!  
No. 349AE047

**39<sup>95</sup>**  
\$34.95 ea./5

HOT NEW IMPORT! REMOTE CONTROL 30 CHANNEL CABLE TV CONVERTER!

**89<sup>95</sup>**  
\$79.95 ea./5  
\$74.95 No. 349VA275 ea./10

Includes remote TV on/off switch and fine tuning control!  
No. 349VA275



ETCO MKII WIRELESS - THE ULTIMATE CABLE TV CONVERTER!



Set TV to channel 3, and the hand-held remote control does it all!  
No. 349ZA008

**189<sup>00</sup>**

VIDCOR 2000 CONVERTER ELIMINATES PROBLEMS WHEN VIDEOTAPEING FROM CABLE TV

**89<sup>95</sup>**  
Restores your VCR's capability for programming. Restores remote channel control. Enables videotaping of one cable program while watching another.  
No. 349VA950



UNUSUAL FACTORY SURPLUS MID-BAND - SUPER-BAND CABLE TV TUNER



Converts cable channels to a common IF frequency. Experimenters - build cable converters, decoders, etc. With schematic. No. 349VA342

**19<sup>95</sup>**  
\$17.50 ea./10

FACTORY SURPLUS UHF TUNERS

**4<sup>95</sup>**  
\$3.95 ea./10

Brand new production surplus. All solid state. Ideal for experimental work building cable TV converters, etc. No. 349SU099



MINIATURE FM WIRELESS MICROPHONE



Hides in the palm of your hand. Reception on any standard FM radio or receiver.  
No. 349VA482

**29<sup>95</sup>**  
\$27.50 ea./5  
\$24.95 ea./10

QUARTER-MILE WIRELESS MICROPHONE & RECEIVER SYSTEM

**69<sup>95</sup>**  
\$49.95 ea./5

FCC approved crystal controlled wireless mike & receiver. All battery operated. Electret wide range response. VU meter.  
No. 349VA093



FACTORY SURPLUS VHF / UHF "TWIN" VARACTOR TUNERS!



Admiral No. NC 3143-1. BRAND NEW! Ideal for building or repairing electronically tuned TV "FRONT ENDS". A hard to find item at a sensational price!  
No. 349VC308

**39<sup>95</sup>**  
\$34.95 ea./5

DUMPING! NORELCO ENDLESS LOOP CASSETTES!

**4<sup>95</sup>**  
\$4.49 ea./10

Impossible to find at any price!  
3 minutes - No. 349VA605  
6 minutes - No. 349VA606



IN STOCK - THE MURA CORDLESS TELEPHONE SYSTEM!



Answer & originate calls with this wireless pocketphone. 400 ft. range! Rechargeable. Last number recall! Paging feature! Use with rotary, touch systems!  
No. 349VA274

**144<sup>88</sup>**  
\$129.95 ea./5

SALE OF QUARTZ BATTERY-OPERATED CLOCK MOVEMENTS!

**9<sup>95</sup>**  
\$8.95 ea./5

Accuracy of 1 min./year up to 4 years operation on 1 alkaline "C" cell. Imported from West Germany. No. 349VA561



20 AMP REGULATED 12VDC POWER SUPPLY!



13.8 vdc no load, 12.5 vdc full load. Easily handles ham station, marine radio, CB, linears up to 400w P.E.P. Brand new, factory sealed. 110 VAC. No. 349VA394

**69<sup>88</sup>**  
\$59.88 ea./5

**FREE**

OUR LATEST 98 PAGE FASCINATING CATALOG - jam-packed with unique items, electronic bargains and unusual offers. Write or circle the information card number below.



ETCO ELECTRONICS NORTH COUNTRY SHOPPING CENTER PLATTSBURGH, N.Y. 12901

Check with order, please. Visa & Mastercard OK. (Sorry, no C.O.D.'s. Add 15% for UPS & Handling (Excess refund). N.Y. State residents add 7% sales tax. Dealer & Export inquiries invited. Our telephone order desk never closes. Call 1-518-561-8700.

CIRCLE 24 ON FREE INFORMATION CARD

# KNAPP ELECTRONIC PARTS

|  |  |  |
|--|--|--|
| <b>Modutec Meter</b><br>2 1/4 x 3"<br>100 ua @ 600 OHM I.R.<br>0-30 AMP<br>0-5 VDC<br>\$3.95                               | <b>Capacitor</b><br>5200 mf. 25v.<br>49¢<br>10/\$4.50  | <b>Voltage Regulator</b><br>Fantastic Buy!<br>TO-3 3 AMP 14.2v.<br>\$1.09  |
| <b>Transformer</b><br>Dual bobbin<br>30V.<br>+14V. 1.5 AMP<br>3" Mount Centers 2" high<br>\$3.00                           | <b>Tri-Color LEDS</b><br>Red/Green reverse volt.<br>Yellow A.C.<br>2/\$1.50                    | <b>Voltage Regulators</b><br>+5V. 7805<br>-5V. 79M05<br>+6V. 7806<br>+12V. 7812<br>5/\$5.50 10/\$9.95  |
| <b>Chassis (H.D.)</b><br>Fantastic!<br>4 X 8 X 2 1/4 H.<br>79¢   | <b>Infrared Emitter and Photo Diode Detector</b><br>XC880-A TIL413 short leads 1 pr.<br>\$2.00 | <b>Jumbo LEDS</b><br>Red, Green or Yellow<br>100/\$8.00 per color  |
| <b>Deluxe Cowl Cabinet</b><br>*Blue Top Grey Lower<br>3" X 4" X 2 1/8" H.<br>\$2.49  | <b>Mura Cordless Telephone</b><br>As Is Complete with schematics<br>\$43.50                    | <b>Coto Mini Relay</b><br>6V. SPST<br>CR 4003-6<br>79¢   |
| <b>Power One Power Supply</b><br>5V. @ 6 AMPS<br>\$23.50   | <b>24v. DC Relay</b><br>3PDT 10 AMP Gold contacts<br>Like P + B KUP Series<br>\$2.49           | <b>Voltage Regulator Boards</b><br>Just hook up to transformer<br>12V. or 9V. 1.5A<br>\$1.29   |
| <b>Power Tec</b><br>5V. @ 12 AMPS<br>\$33.50   | <b>Mini Switches</b><br>Micro Switch<br>SPDT<br>w/long blue paddle<br>79¢                      | <b>Popular Prime Transistors</b><br>ECG 123 AP or ECG159<br>6/\$1.00<br>100/\$10.00  |
| <b>TRANSFORMER</b><br>36V. 200 MA.<br>99¢  | <b>Compu-Lite</b><br>red push (Illuminated)<br>mom #849-1191<br>69¢                            | <b>Special RG59U Cable</b><br>Foam + 80% Shield<br>\$5.00/100 FT.  |
| <b>SEND FOR FREE 1982 CATALOG</b><br>or call us at (813) 392-0406  |  | <b>Dip Tantalum Caps</b><br>dipped and solid<br>100 @ 3V. 6.8, 10, 15, 22, 33, 47, @ 6.3V.<br>22, 68 @ 10V.<br>1.5, 3.3, 4.7, 6.8 @ 16V.<br>15 @ 20V.<br>47, 68, 1.5, 2.2, 3.3, 4.7, 6.8 @ 35V.<br>22, 68, 1 @ 50V.<br>25¢ |
| <b>add 10% for shipping and handling</b>   |  | <b>Audio Amplifier</b><br>8 watt<br>4" x 3" x 2" H.<br>\$5.95  |
| <b>min charge \$2.50</b>   |  | <b>Solid State Buzzer</b><br>12V.<br>98¢   |
| <b>H.J. Knapp of Florida, Inc.</b><br>4750 96th St. N. St. Petersburg, Florida 33708<br>CIRCLE 25 ON FREE INFORMATION CARD |  |  |

## FREE CATALOG OF Burglar/Fire Alarms

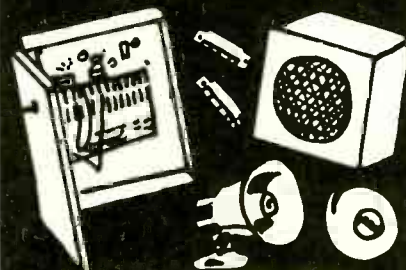

- Controls • Power Sources
- Remote Stations • Holdup Alarms
- Wireless Components • Magnetic Contacts • Ultrasonic • Microwave • Infrared
- Sirens • Bells • Glass Protection • Shock Sensors • Phone Dialers • CCTV • Locks • Safes

**mountain west**

4215 N. 16th St. Dept. RE-3  
Phoenix, Arizona 86016

1-800-528-6169

CIRCLE 30 ON FREE INFORMATION CARD

PAT. # 4,259,705

**WARNING!**

Electric Power Pollution, Spikes, Interference & Lightning HAZARDOUS to HIGH TECH EQUIPMENT!!



MicroComputers, VTR, Hi-Fi, Lasers, Spectrometers are often damaged or disrupted due to Power Pollution.

High Tech components may interact!

Our patented ISOLATORS eliminate equipment interaction, curb damaging Power Line Spikes, Tame Lightning bursts & clean up interference.

Isolated 3-prong sockets; integral Spike/Lightning Suppressor. 125 V, 15 A, 1875 W Total, 1 KW per socket.

ISO-1 ISOLATOR. 3 Isolated Sockets; Quality Spike Suppression; Basic Protection . . . . . \$69.95

ISO-3 SUPER-ISOLATOR. 3 DUAL Isolated Sockets; Suppressor; Commercial Protection . . . . . \$104.95

ISO-17MAGNUM ISOLATOR. 4 QUAD Isolated Skts; Suppressor; Laboratory Grade Protection . . . . . \$181.95

Master-Charge, Visa, American Express

TOLL FREE ORDER DESK 1-800-225-4876

(except AK, HI, MA, PR & Canada)

**SATISFACTION GUARANTEED!**

**Electronic Specialists, Inc.**

171 South Main Street. Natick, MA 01760

Technical & Non-800: 1-617-655-1532

CIRCLE 31 ON FREE INFORMATION CARD







# ADVANCED COMPUTER PRODUCTS

FIRST TO OFFER PRIME PRODUCTS TO THE HOBBYIST AT FAIR PRICES!

1. Proven Quality Factory tested products only.
2. Guaranteed Satisfaction Call For Special School Discounts

SALE 4164 \$19.95

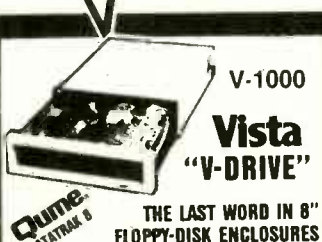

**V-1000 Vista "V-DRIVE"**

THE LAST WORD IN 8" FLOPPY-DISK ENCLOSURES

THE VISTA V-1000 FLOPPY DISK DRIVE SUBSYSTEM

- Deluxe chassis with external side access for drive positioning and mounting
- Built to mechanically and electrically accommodate single sided drives - including the most popular 8-inch Winchester and Shugart floppy disk drives, and 8-inch streaming tape units
- Storage capacity from 0.5 to 40 megabytes
- Industrial quality cabinet with cast front panel
- Meets all U.S. and GEMA standards
- Additional Sawtooth front and rear terminals provided at no extra charge (no external access)
- Desk or rack mountable
- Features modular construction with removable sub-assembly that allows easy cabinet positioning and mounting
- Drives pull out for easy service and maintenance

**QUME® DataTrack 8**

**CABINET WITH (2) single sided drives (including power supply & cable) \$395**

**CABINET WITH (2) double sided drives (including power supply & cable) \$1495**

**CABINET WITH (2) double sided drives (including power supply & cable) \$1995**

FOR TRS 80<sup>®</sup> MODEL I, PMC 80, ZENITH H89, S-100, etc.

**ONLY 310<sup>00</sup> ea. MODEL V-801, 80 TRACKS, SS**

**ONLY 425<sup>00</sup> ea. 2 DRIVE CABLE... 29.95 4 DRIVE CABLE... 39.95**

**MOSTEK MK4015 4K Dynamic RAM**

Refresh while supply lasts only .49¢ Pin equivalent to MK4027 except has 1 ms.

**S-100 WW \$2.99 each**

FIRST QUALITY AT SURPLUS PRICE

**2708 EPROMS PRIME-450 Ns. 8 for \$29.95**

**4K STATIC RAM SELL-OFF**

Zilog 6104-4

Same as TMS 4044 but designed specifically for Z-80 based systems. This is full-spec 4K x 1 RAM, 450 Ns.

While supply lasts \$1.49 each.

**SPECIAL PURCHASE \$59.95 Limited Supply \$59.95**

16K Altair RAM Boards. Fully Populated as is.

**FLOPPY DISK DRIVES**

QUME® DataTrack 8

- Double Sided
- Double Density

**ACP LOW PRICE \$569.95**

|   |         |
|---|---------|
| Tandem TM100 1.5" 5 1/4" Disk Drive                 | 249.85  |
| MPI B51-5V, 40 Tracks                               | 75.00   |
| Shugart SA400 5 1/4" 35 tracks                      | 295.00  |
| Shugart 800/801R 8"                                 | 449.00  |
| Siemens Shugart Compatible Model FDD 120-80"        | 429.00  |
| PERCSI Model 277 Dual                               | 1195.00 |
| MPI B52 5" Dual                                     | 348.00  |
| WANG/OSIEMENS 8"                                    | 290.00  |
| MPI B1 Double Track Density Single Side, 80 Tracks  | 375.00  |
| MPI B2 Double Track Density Double Side, 160 Tracks | 475.00  |

**6800 MICROMODULE™ PRICE LIST**

| MODEL NO. | DESCRIPTION                        | PRICE    |
|-----------|------------------------------------|----------|
| 9600A     | Single Board Microcomputer         | \$495.00 |
| 9609      | Advanced Single Board Comp. (6809) | \$595.00 |
| 9601      | 16 Slot Mother Board               | 175.00   |
| 9602      | 8 Slot Mother Board                | 100.00   |
| 9603      | 8 Slot Mother Board                | 100.00   |
| 9604      | Power Supply                       | 275.00   |
| 9605      | DC Input Power Supply              | 325.00   |
| 9610      | Utility Proto Board                | 39.00    |
| 9611      | Arith. Proc/Memory Module          | 495.00   |
| 9612      | Buffered Utility Proto Board       | 49.00    |
| 9616      | 32K EPROM/RAM Module               | 250.00   |
| 9617      | EPROM Programming Head             | 250.00   |
| 9620      | 16 Channel Parallel I/O Module     | 295.00   |
| 9622      | Seriat/Parallel I/O Module         | 325.00   |
| 9627      | 16K Static RAM Module 470ns        | 395.00   |
| 9629      | 32K Static RAM 450ns               | 695.00   |
| 9629A     | 32K Static RAM 200ns               | 895.00   |
| 9630      | Carid Extender                     | 39.00    |
| 9640      | Multiple Programmable Timer        | 295.00   |
| 9650      | 8 Channel Duplex Seriat I/O Mod    | 395.00   |
| 9655      | Intelligent Tape Controller        | 275.00   |
| 96103     | 32/32 I/O Module                   | 275.00   |
| 96702     | Contact Closure Module             | 350.00   |

UNPOPULATED BOARDS (Also Available)

**BECKMAN DIGITAL MULTIMETERS**

|                             |         |
|-----------------------------|---------|
| TECH 300 Digital Multimeter | \$110   |
| TECH 310 Digital Multimeter | \$140   |
| TECH 330 Digital Multimeter | \$140   |
| DC-201 Vinyl Carrying Case  | \$19.95 |
| DC-202 Deluxe Carrying Case | \$24    |
| HV-211 High Voltage Probe   | \$35    |
| RP-221 RF Probe             | \$32    |
| CT-231 A.C. Current Clamp   | \$35    |
| DL-242 Deluxe Test Lead Kit | \$16    |
| TL-242 Square Test Leads    | \$6     |

**NEC PC-8000 Series Microcomputer System.**

**NEW INTRO PRICING \$1099.00**

- Z-80A CPU 4 MHz
- 5 user programmable function keys
- 82 Keys with numeric keypad
- 160x100 resolution
- 80 character screen

PC-8001A Microcomputer w/32K RAM \$1295.00 1099.00

PC-8012A I/O Unit w/32K RAM \$795.00 699.00

PC-8013A Dual Mini-Disk Drive Unit \$1295.00 1099.00

PC-8032A Add-On Dual Mini-Disk Drive Unit \$1095.00 949.00

PC-8023A Impact Matrix Printer, Tractor/Friction Feed \$860.00 769.00

PC-8098A Cable for PC-8032A Printer \$49.95 44.95

JB-1201M(A) High Resolution, Green Monitor \$285.00 239.00

Color Monitor w/RGB Input \$1195.00 1099.00

PC-8091A RGB Cable for JC-1202DH(A) Color Monitor \$19.95 17.95

Basic Language Learning Guide \$19.95 19.95

PC-8001A Microcomputer Reference Manual \$19.95 19.95

PC-8012A I/O Unit User's Manual \$14.95 14.95

PC-8031A Dual Disk User's Manual \$14.95 14.95

**RETAIL STORES OPEN MON-SAT**

STORE #1: 1310 "B" E. Edinger, Santa Ana, CA 92705 Showrooms, Retail, Warehouse

STORE #2: 542 W. Trimble Road, San Jose, CA 95131 • (408) 946-7010

Direct Order Lines: (714) 558-8813 (800) 854-8230 or (800) 854-8241

**\$24.95 TRS-80/APPLE \$24.95**

MEMORY EXPANSION KITS

4116's, 16K (200/250 ns.)

8-pcs for \$24.95 Specify Computer Call For Volume Pricing

**16K RAM**

**CENTRONICS PRINTER**

Model 737

- Centronics complete printer
- The 737 has everything. Check and compare the features.
- New low price \$835.00

**32K STATIC RAM BOARD**

2 or 4 MHz Expandable uses 2114L's

S-100

|                      |                 |
|----------------------|-----------------|
| 16K 4 MHz KIT        | \$59.95         |
| 16K 4 MHz A&T        | 217.95          |
| 32K MHz KIT          | 289.95          |
| 32K 4 MHz A&T        | 339.00          |
| Bare Board           | 39.95           |
| Bare Bd. w/all parts | less mem. 39.95 |

**NEW! from Zilog**

Z-8 CPU comes with Tiny Basic & debug program on the I.C.

**\$69.95 w/data**

**BIPOLAR CPU SALE**

Signetics 8x300 8 bit CPU

While stock lasts 14.95 ea.

**UV "Eprom" Eraser**

Model Uvs-11E \$69.95

Holds 4 Eprom's at a time Backed by 45 years experience

Model S-52T... \$325.00

Professional Industrial Model

**NON-LINEAR SYSTEMS, INC. TOUCH-TEST 20**

DIGITAL MULTIMETER \$319<sup>95</sup>

**6800 SUPPORT CHIPS**

|                      |       |
|----------------------|-------|
| 8125/8156 I/O        | 24.95 |
| 8125/8156 I/O        | 64.34 |
| 8202 Dyn. Ram Cont.  | 34.85 |
| 8202/745 136 Decoder | 27.95 |
| 8202/745 136 Decoder | 27.95 |
| 8214 Priority Int.   | 2.25  |
| 8218 Bus Driver      | 2.25  |
| 8220/618 500 Gen     | 2.25  |
| 8224A 4MHz           | 9.75  |
| 8228 Bus Driver      | 2.25  |
| 8228/810 800 Gen     | 2.25  |
| 8228 Sys. Control    | 4.50  |
| 8238 Sys. Cont.      | 4.50  |
| 8243 I/O Exp.        | 15.95 |
| 8250 Asyn. Comm      | 15.95 |
| 8251 Prog. I/O       | 8.25  |
| 8253 I/O Timer       | 8.25  |
| 8258 Prog. I/O       | 5.50  |
| 8258 Prog. DMA       | 5.50  |
| 8258 Prog. Int.      | 15.95 |
| 8275 CRT Controller  | 45.95 |
| 8275 Prog. Keyboard  | 15.95 |

**INTERSYSTEMS**

The Preferred S-100 Box

The new Series II CPU Board features a 4 MHz Z-80A CPU and full-feature front panel. 20-slot actively terminated motherboard, with 25 amp power supply (50/60 Hz operation, incl. 68 cm fan).

DPS-1, \$1795

**MOS PROMS**

|                 |       |
|-----------------|-------|
| 27E16K(8178)    | 89.95 |
| 2732 (4Kx8)T8   | 16.95 |
| 2764 (8Kx8)T8   | 16.95 |
| 27128 (16Kx8)T8 | 17.95 |
| 27256 (32Kx8)T8 | 17.95 |
| 27512 (64Kx8)T8 | 17.95 |
| 2708 (16Kx8)N8  | 7.50  |
| 2708 (16Kx8)N8  | 7.50  |
| 1702A           | 6.25  |
| MM5203AG        | 14.50 |
| MM5204C         | 9.95  |

**CHARACTER GEN.**

|                        |       |
|------------------------|-------|
| 2513-001 (5V) Upper    | 9.50  |
| 2513-005 (5V) Lower    | 9.50  |
| 2513-ADM3 (5V) Lower   | 14.95 |
| MCM68710 Ascii Shifted | 12.95 |
| MCM68740 Math Symbol   | 13.45 |
| MCM68750 Alpha Control | 14.45 |

**UARTS/BAUD RATE**

|                      |      |
|----------------------|------|
| 1E16028 (5V) 12V     | 4.95 |
| 1E16029 (5V) 12V     | 4.95 |
| AY51014A (16125-14V) | 6.95 |
| AY51015A (18535V)    | 6.95 |
| 1E16028 (5V) 12V     | 4.95 |
| 1E16029 (5V) 12V     | 4.95 |
| 1E16030 (5V) 12V     | 4.95 |
| 1E16031 (5V) 12V     | 4.95 |
| 1E16032 (5V) 12V     | 4.95 |
| 1E16033 (5V) 12V     | 4.95 |
| 1E16034 (5V) 12V     | 4.95 |
| 1E16035 (5V) 12V     | 4.95 |
| 1E16036 (5V) 12V     | 4.95 |
| 1E16037 (5V) 12V     | 4.95 |
| 1E16038 (5V) 12V     | 4.95 |
| 1E16039 (5V) 12V     | 4.95 |
| 1E16040 (5V) 12V     | 4.95 |
| 1E16041 (5V) 12V     | 4.95 |
| 1E16042 (5V) 12V     | 4.95 |
| 1E16043 (5V) 12V     | 4.95 |
| 1E16044 (5V) 12V     | 4.95 |
| 1E16045 (5V) 12V     | 4.95 |
| 1E16046 (5V) 12V     | 4.95 |
| 1E16047 (5V) 12V     | 4.95 |
| 1E16048 (5V) 12V     | 4.95 |
| 1E16049 (5V) 12V     | 4.95 |
| 1E16050 (5V) 12V     | 4.95 |
| 1E16051 (5V) 12V     | 4.95 |
| 1E16052 (5V) 12V     | 4.95 |
| 1E16053 (5V) 12V     | 4.95 |
| 1E16054 (5V) 12V     | 4.95 |
| 1E16055 (5V) 12V     | 4.95 |
| 1E16056 (5V) 12V     | 4.95 |
| 1E16057 (5V) 12V     | 4.95 |
| 1E16058 (5V) 12V     | 4.95 |
| 1E16059 (5V) 12V     | 4.95 |
| 1E16060 (5V) 12V     | 4.95 |
| 1E16061 (5V) 12V     | 4.95 |
| 1E16062 (5V) 12V     | 4.95 |
| 1E16063 (5V) 12V     | 4.95 |
| 1E16064 (5V) 12V     | 4.95 |
| 1E16065 (5V) 12V     | 4.95 |
| 1E16066 (5V) 12V     | 4.95 |
| 1E16067 (5V) 12V     | 4.95 |
| 1E16068 (5V) 12V     | 4.95 |
| 1E16069 (5V) 12V     | 4.95 |
| 1E16070 (5V) 12V     | 4.95 |
| 1E16071 (5V) 12V     | 4.95 |
| 1E16072 (5V) 12V     | 4.95 |
| 1E16073 (5V) 12V     | 4.95 |
| 1E16074 (5V) 12V     | 4.95 |
| 1E16075 (5V) 12V     | 4.95 |
| 1E16076 (5V) 12V     | 4.95 |
| 1E16077 (5V) 12V     | 4.95 |
| 1E16078 (5V) 12V     | 4.95 |
| 1E16079 (5V) 12V     | 4.95 |
| 1E16080 (5V) 12V     | 4.95 |
| 1E16081 (5V) 12V     | 4.95 |
| 1E16082 (5V) 12V     | 4.95 |
| 1E16083 (5V) 12V     | 4.95 |
| 1E16084 (5V) 12V     | 4.95 |
| 1E16085 (5V) 12V     | 4.95 |
| 1E16086 (5V) 12V     | 4.95 |
| 1E16087 (5V) 12V     | 4.95 |
| 1E16088 (5V) 12V     | 4.95 |
| 1E16089 (5V) 12V     | 4.95 |
| 1E16090 (5V) 12V     | 4.95 |
| 1E16091 (5V) 12V     | 4.95 |
| 1E16092 (5V) 12V     | 4.95 |
| 1E16093 (5V) 12V     | 4.95 |
| 1E16094 (5V) 12V     | 4.95 |
| 1E16095 (5V) 12V     | 4.95 |
| 1E16096 (5V) 12V     | 4.95 |
| 1E16097 (5V) 12V     | 4.95 |
| 1E16098 (5V) 12V     | 4.95 |
| 1E16099 (5V) 12V     | 4.95 |
| 1E16100 (5V) 12V     | 4.95 |

**MICROPROCESSORS**

|                                    |          |
|------------------------------------|----------|
| Z8001 16 bit 68M                   | \$189.00 |
| Z8002 16 bit 64K                   | 149.00   |
| Z8003                              | 18.95    |
| Z8004                              | 13.95    |
| F-8 (350SI)                        | 16.95    |
| 2850                               | 16.95    |
| IC1802                             | 29.75    |
| 8080A                              | 4.75     |
| 8080A-4MHz                         | 19.95    |
| 8088                               | 14.95    |
| 8088-4MHz                          | 19.95    |
| 8088-8MHz                          | 14.95    |
| 8088-16MHz                         | 19.95    |
| 8088-32MHz                         | 14.95    |
| 8088-64MHz                         | 19.95    |
| 8088-128MHz                        | 14.95    |
| 8088-256MHz                        | 19.95    |
| 8088-512MHz                        | 14.95    |
| 8088-1024MHz                       | 19.95    |
| 8088-2048MHz                       | 14.95    |
| 8088-4096MHz                       | 19.95    |
| 8088-8192MHz                       | 14.95    |
| 8088-16384MHz                      | 19.95    |
| 8088-32768MHz                      | 14.95    |
| 8088-65536MHz                      | 19.95    |
| 8088-131072MHz                     | 14.95    |
| 8088-262144MHz                     | 19.95    |
| 8088-524288MHz                     | 14.95    |
| 8088-1048576MHz                    | 19.95    |
| 8088-2097152MHz                    | 14.95    |
| 8088-4194304MHz                    | 19.95    |
| 8088-8388608MHz                    | 14.95    |
| 8088-16777216MHz                   | 19.95    |
| 8088-33554432MHz                   | 14.95    |
| 8088-67108864MHz                   | 19.95    |
| 8088-134217728MHz                  | 14.95    |
| 8088-268435456MHz                  | 19.95    |
| 8088-536870912MHz                  | 14.95    |
| 8088-1073741824MHz                 | 19.95    |
| 8088-2147483648MHz                 | 14.95    |
| 8088-4294967296MHz                 | 19.95    |
| 8088-8589934592MHz                 | 14.95    |
| 8088-17179869184MHz                | 19.95    |
| 8088-34359738368MHz                | 14.95    |
| 8088-68719476736MHz                | 19.95    |
| 8088-137438953472MHz               | 14.95    |
| 8088-274877906944MHz               | 19.95    |
| 8088-549755813888MHz               | 14.95    |
| 8088-1099511627776MHz              | 19.95    |
| 8088-2199023255552MHz              | 14.95    |
| 8088-4398046511104MHz              | 19.95    |
| 8088-8796093022208MHz              | 14.95    |
| 8088-1759218644416MHz              | 19.95    |
| 8088-3518437288832MHz              | 14.95    |
| 8088-7036874577664MHz              | 19.95    |
| 8088-1407374915328MHz              | 14.95    |
| 8088-2814749830656MHz              | 19.95    |
| 8088-5629499661312MHz              | 14.95    |
| 8088-11258999326224MHz             | 19.95    |
| 8088-22517998652448MHz             | 14.95    |
| 8088-4503599730496MHz              | 19.95    |
| 8088-9007199460992MHz              | 14.95    |
| 8088-18014398919808MHz             | 19.95    |
| 8088-36028797839616MHz             | 14.95    |
| 8088-72057595679232MHz             | 19.95    |
| 8088-144115191384448MHz            | 14.95    |
| 8088-288230382768896MHz            | 19.95    |
| 8088-576460765537792MHz            | 14.95    |
| 8088-1152921531075584MHz           | 19.95    |
| 8088-2305843062151168MHz           | 14.95    |
| 8088-4611686124302336MHz           | 19.95    |
| 8088-9223372248604672MHz           | 14.95    |
| 8088-18446744737211344MHz          | 19.95    |
| 8088-36893489474422688MHz          | 14.95    |
| 8088-73786978948845376MHz          | 19.95    |
| 8088-14757397797770752MHz          | 14.95    |
| 8088-29514795595541504MHz          | 19.95    |
| 8088-59029591190893008MHz          | 14.95    |
| 8088-11805918237817600MHz          | 19.95    |
| 8088-23611836475635200MHz          | 14.95    |
| 8088-472236729512664000MHz         | 19.95    |
| 8088-94447345903328000MHz          | 14.95    |
| 8088-188894691806560000MHz         | 19.95    |
| 8088-377789383613120000MHz         | 14.95    |
| 8088-755578767226240000MHz         | 19.95    |
| 8088-1511157534452800000MHz        | 14.95    |
| 8088-3022315068905600000MHz        | 19.95    |
| 8088-60446301378112000000MHz       | 14.95    |
| 8088-120892602763224000000MHz      | 19.95    |
| 8088-241785205526448000000MHz      | 14.95    |
| 8088-483570411052976000000MHz      | 19.95    |
| 8088-9671408221059520000000MHz     | 14.95    |
| 8088-19342964442118400000000MHz    | 19.95    |
| 8088-38685928884236800000000MHz    | 14.95    |
| 8088-77371857768473600000000MHz    | 19.95    |
| 8088-1547437155376953600000000MHz  | 14.95    |
| 8088-3094874310753907200000000MHz  | 19.95    |
| 8088-6189748621507814400000000MHz  | 14.95    |
| 8088-12379497243156288000000000MHz | 19.95    |
| 8088-24758994486312576000000000MHz | 14.95    |
| 8088-49517988972625152000000000MHz | 19.95    |
| 8088-99035977945250304000000000MHz | 1        |



# 7400

|         |     |          |      |          |      |          |      |
|---------|-----|----------|------|----------|------|----------|------|
| SN7400N | .19 | SN74123N | .59  | SN74150N | .26  | SN74156N | 1.19 |
| SN7401N | .22 | SN74125N | .39  | SN74151N | 2.19 | SN74157N | .89  |
| SN7402N | .22 | SN74126N | .44  | SN74152N | .28  | SN74158N | 2.48 |
| SN7403N | .22 | SN74128N | .59  | SN74153N | .28  | SN74159N | 1.15 |
| SN7404N | .22 | SN74132N | .69  | SN74154N | .35  | SN74160N | 1.15 |
| SN7405N | .22 | SN74136N | .75  | SN74155N | .35  | SN74161N | 1.15 |
| SN7406N | .23 | SN74139N | .85  | SN74156N | .35  | SN74162N | 1.15 |
| SN7407N | .23 | SN74141N | .79  | SN74157N | .35  | SN74163N | 1.15 |
| SN7408N | .26 | SN74142N | 2.95 | SN74158N | .35  | SN74164N | 1.15 |
| SN7409N | .23 | SN74143N | 2.95 | SN74159N | .35  | SN74165N | 1.15 |
| SN7410N | .22 | SN74144N | 2.95 | SN74160N | .35  | SN74166N | 1.15 |
| SN7411N | .22 | SN74145N | 1.95 | SN74161N | .35  | SN74167N | 1.15 |
| SN7412N | .29 | SN74147N | 1.95 | SN74162N | .35  | SN74168N | 1.15 |
| SN7413N | .39 | SN74148N | 1.20 | SN74163N | .35  | SN74169N | 1.15 |
| SN7414N | .59 | SN74150N | 1.09 | SN74164N | .35  | SN74170N | 1.15 |
| SN7415N | .29 | SN74151N | .67  | SN74165N | .35  | SN74171N | 1.15 |
| SN7416N | .22 | SN74152N | .67  | SN74166N | .35  | SN74172N | 1.15 |
| SN7417N | .22 | SN74153N | .87  | SN74167N | .35  | SN74173N | 1.15 |
| SN7418N | .35 | SN74154N | 1.19 | SN74168N | .35  | SN74174N | 1.15 |
| SN7419N | .29 | SN74155N | .78  | SN74169N | .35  | SN74175N | 1.15 |
| SN7420N | .29 | SN74156N | .69  | SN74170N | .35  | SN74176N | 1.15 |
| SN7421N | .29 | SN74157N | .69  | SN74171N | .35  | SN74177N | 1.15 |
| SN7422N | .29 | SN74158N | 1.65 | SN74172N | .35  | SN74178N | 1.15 |
| SN7423N | .25 | SN74159N | .88  | SN74173N | .35  | SN74179N | 1.15 |
| SN7424N | .25 | SN74160N | .88  | SN74174N | .35  | SN74180N | 1.15 |
| SN7425N | .25 | SN74161N | .88  | SN74175N | .35  | SN74181N | 1.15 |
| SN7426N | .25 | SN74162N | .89  | SN74176N | .35  | SN74182N | 1.15 |
| SN7427N | .25 | SN74163N | .89  | SN74177N | .35  | SN74183N | 1.15 |
| SN7428N | .25 | SN74164N | .89  | SN74178N | .35  | SN74184N | 1.15 |
| SN7429N | .25 | SN74165N | .89  | SN74179N | .35  | SN74185N | 1.15 |
| SN7430N | .23 | SN74166N | .87  | SN74180N | .35  | SN74186N | 1.15 |
| SN7431N | .23 | SN74167N | .95  | SN74181N | .35  | SN74187N | 1.15 |
| SN7432N | .23 | SN74168N | 1.99 | SN74182N | .35  | SN74188N | 1.15 |
| SN7433N | .23 | SN74169N | 1.65 | SN74183N | .35  | SN74189N | 1.15 |
| SN7434N | .23 | SN74170N | 1.65 | SN74184N | .35  | SN74190N | 1.15 |
| SN7435N | .23 | SN74171N | 1.65 | SN74185N | .35  | SN74191N | 1.15 |
| SN7436N | .23 | SN74172N | 1.65 | SN74186N | .35  | SN74192N | 1.15 |
| SN7437N | .23 | SN74173N | 1.65 | SN74187N | .35  | SN74193N | 1.15 |
| SN7438N | .23 | SN74174N | 1.65 | SN74188N | .35  | SN74194N | 1.15 |
| SN7439N | .23 | SN74175N | 1.65 | SN74189N | .35  | SN74195N | 1.15 |
| SN7440N | .19 | SN74176N | 1.99 | SN74190N | .35  | SN74196N | 1.15 |
| SN7441N | .79 | SN74177N | 1.65 | SN74191N | .35  | SN74197N | 1.15 |
| SN7442N | .57 | SN74178N | 4.75 | SN74192N | .35  | SN74198N | 1.15 |
| SN7443N | .95 | SN74179N | 7.75 | SN74193N | .35  | SN74199N | 1.15 |
| SN7444N | .95 | SN74180N | 7.75 | SN74194N | .35  | SN74200N | 1.15 |
| SN7445N | .79 | SN74181N | 8.9  | SN74195N | .35  | SN74201N | 1.15 |
| SN7446N | .79 | SN74182N | 8.9  | SN74196N | .35  | SN74202N | 1.15 |
| SN7447N | .75 | SN74183N | 8.9  | SN74197N | .35  | SN74203N | 1.15 |
| SN7448N | .75 | SN74184N | 8.9  | SN74198N | .35  | SN74204N | 1.15 |
| SN7449N | .75 | SN74185N | 8.9  | SN74199N | .35  | SN74205N | 1.15 |
| SN7450N | .75 | SN74186N | 8.9  | SN74200N | .35  | SN74206N | 1.15 |
| SN7451N | .19 | SN74187N | 1.15 | SN74201N | .35  | SN74207N | 1.15 |
| SN7452N | .19 | SN74188N | 1.15 | SN74202N | .35  | SN74208N | 1.15 |
| SN7453N | .19 | SN74189N | 1.15 | SN74203N | .35  | SN74209N | 1.15 |
| SN7454N | .19 | SN74190N | 1.15 | SN74204N | .35  | SN74210N | 1.15 |
| SN7455N | .19 | SN74191N | 1.15 | SN74205N | .35  | SN74211N | 1.15 |
| SN7456N | .19 | SN74192N | 1.15 | SN74206N | .35  | SN74212N | 1.15 |
| SN7457N | .19 | SN74193N | 1.15 | SN74207N | .35  | SN74213N | 1.15 |
| SN7458N | .19 | SN74194N | 1.15 | SN74208N | .35  | SN74214N | 1.15 |
| SN7459N | .19 | SN74195N | 1.15 | SN74209N | .35  | SN74215N | 1.15 |
| SN7460N | .19 | SN74196N | 1.15 | SN74210N | .35  | SN74216N | 1.15 |
| SN7461N | .19 | SN74197N | 1.15 | SN74211N | .35  | SN74217N | 1.15 |
| SN7462N | .19 | SN74198N | 1.15 | SN74212N | .35  | SN74218N | 1.15 |
| SN7463N | .19 | SN74199N | 1.15 | SN74213N | .35  | SN74219N | 1.15 |
| SN7464N | .19 | SN74200N | 1.15 | SN74214N | .35  | SN74220N | 1.15 |
| SN7465N | .19 | SN74201N | 1.15 | SN74215N | .35  | SN74221N | 1.15 |
| SN7466N | .19 | SN74202N | 1.15 | SN74216N | .35  | SN74222N | 1.15 |
| SN7467N | .19 | SN74203N | 1.15 | SN74217N | .35  | SN74223N | 1.15 |
| SN7468N | .19 | SN74204N | 1.15 | SN74218N | .35  | SN74224N | 1.15 |
| SN7469N | .19 | SN74205N | 1.15 | SN74219N | .35  | SN74225N | 1.15 |
| SN7470N | .19 | SN74206N | 1.15 | SN74220N | .35  | SN74226N | 1.15 |
| SN7471N | .19 | SN74207N | 1.15 | SN74221N | .35  | SN74227N | 1.15 |
| SN7472N | .19 | SN74208N | 1.15 | SN74222N | .35  | SN74228N | 1.15 |
| SN7473N | .19 | SN74209N | 1.15 | SN74223N | .35  | SN74229N | 1.15 |
| SN7474N | .19 | SN74210N | 1.15 | SN74224N | .35  | SN74230N | 1.15 |
| SN7475N | .19 | SN74211N | 1.15 | SN74225N | .35  | SN74231N | 1.15 |
| SN7476N | .19 | SN74212N | 1.15 | SN74226N | .35  | SN74232N | 1.15 |
| SN7477N | .19 | SN74213N | 1.15 | SN74227N | .35  | SN74233N | 1.15 |
| SN7478N | .19 | SN74214N | 1.15 | SN74228N | .35  | SN74234N | 1.15 |
| SN7479N | .19 | SN74215N | 1.15 | SN74229N | .35  | SN74235N | 1.15 |
| SN7480N | .19 | SN74216N | 1.15 | SN74230N | .35  | SN74236N | 1.15 |
| SN7481N | .19 | SN74217N | 1.15 | SN74231N | .35  | SN74237N | 1.15 |
| SN7482N | .19 | SN74218N | 1.15 | SN74232N | .35  | SN74238N | 1.15 |
| SN7483N | .19 | SN74219N | 1.15 | SN74233N | .35  | SN74239N | 1.15 |
| SN7484N | .19 | SN74220N | 1.15 | SN74234N | .35  | SN74240N | 1.15 |
| SN7485N | .19 | SN74221N | 1.15 | SN74235N | .35  | SN74241N | 1.15 |
| SN7486N | .19 | SN74222N | 1.15 | SN74236N | .35  | SN74242N | 1.15 |
| SN7487N | .19 | SN74223N | 1.15 | SN74237N | .35  | SN74243N | 1.15 |
| SN7488N | .19 | SN74224N | 1.15 | SN74238N | .35  | SN74244N | 1.15 |
| SN7489N | .19 | SN74225N | 1.15 | SN74239N | .35  | SN74245N | 1.15 |
| SN7490N | .19 | SN74226N | 1.15 | SN74240N | .35  | SN74246N | 1.15 |
| SN7491N | .19 | SN74227N | 1.15 | SN74241N | .35  | SN74247N | 1.15 |
| SN7492N | .19 | SN74228N | 1.15 | SN74242N | .35  | SN74248N | 1.15 |
| SN7493N | .19 | SN74229N | 1.15 | SN74243N | .35  | SN74249N | 1.15 |
| SN7494N | .19 | SN74230N | 1.15 | SN74244N | .35  | SN74250N | 1.15 |
| SN7495N | .19 | SN74231N | 1.15 | SN74245N | .35  | SN74251N | 1.15 |
| SN7496N | .19 | SN74232N | 1.15 | SN74246N | .35  | SN74252N | 1.15 |
| SN7497N | .19 | SN74233N | 1.15 | SN74247N | .35  | SN74253N | 1.15 |
| SN7498N | .19 | SN74234N | 1.15 | SN74248N | .35  | SN74254N | 1.15 |
| SN7499N | .19 | SN74235N | 1.15 | SN74249N | .35  | SN74255N | 1.15 |
| SN7500N | .19 | SN74236N | 1.15 | SN74250N | .35  | SN74256N | 1.15 |

# 74LS00

|           |     |            |      |            |      |
|-----------|-----|------------|------|------------|------|
| SN74LS00N | .19 | SN74LS150N | .26  | SN74LS164N | 1.19 |
| SN74LS01N | .22 | SN74LS151N | 2.19 | SN74LS165N | .89  |
| SN74LS02N | .22 | SN74LS152N | .28  | SN74LS166N | 2.48 |
| SN74LS03N | .22 | SN74LS153N | .28  | SN74LS167N | 1.15 |
| SN74LS04N | .22 | SN74LS154N | .35  | SN74LS168N | 1.15 |
| SN74LS05N | .22 | SN74LS155N | .35  | SN74LS169N | 1.15 |
| SN74LS06N | .22 | SN74LS156N | .35  | SN74LS170N | 1.99 |
| SN74LS07N | .22 | SN74LS157N | .35  | SN74LS171N | .99  |
| SN74LS08N | .22 | SN74LS158N | .35  | SN74LS172N | .99  |
| SN74LS09N | .22 | SN74LS159N | .35  | SN74LS173N | .99  |
| SN74LS10N | .22 | SN74LS160N | .35  | SN74LS174N | .99  |
| SN74LS11N | .22 | SN74LS161N | .35  | SN74LS175N | .99  |
| SN74LS12N | .29 | SN74LS162N | .39  | SN74LS176N | 2.20 |
| SN74LS13N | .39 | SN74LS163N | .39  | SN74LS177N | 2.20 |
| SN74LS14N | .39 | SN74LS164N | .39  | SN74LS178N | 2.20 |
| SN74LS15N | .39 | SN74LS165N | .39  | SN74LS179N | 2.20 |
| SN74LS16N | .39 | SN74LS166N | .39  | SN74LS180N | 2.20 |
| SN74LS17N | .39 | SN74LS167N | .39  | SN74LS181N | 2.20 |
| SN74LS18N | .39 | SN74LS168N | .39  | SN74LS182N | 2.20 |
| SN74LS19N | .39 | SN74LS169N | .39  | SN74LS183N | 2.20 |
| SN74LS20N | .39 | SN74LS170N | .39  | SN74LS184N | 2.20 |
| SN74LS21N | .39 | SN74LS171N | .39  | SN74LS185N | 2.20 |
| SN74LS22N | .39 | SN74LS172N | .39  | SN74LS186N | 2.20 |
| SN74LS23N | .39 | SN74LS173N | .39  | SN74LS187N | 2.20 |
| SN74LS24N | .39 | SN74LS174N | .39  | SN74LS188N | 2.20 |
| SN74LS25N | .39 | SN74LS175N | .39  | SN74LS189N | 2.20 |
| SN74LS26N | .39 | SN74LS176N | .39  | SN74LS190N | 2.20 |
| SN74LS27N | .39 | SN74LS177N | .39  | SN74LS191N | 2.20 |
| SN74LS28N | .39 | SN74LS178N | .39  | SN74LS192N | 2.20 |
| SN74LS29N | .39 | SN74LS179N | .39  | SN74LS193N | 2.20 |
| SN74LS30N | .39 | SN74LS180N | .39  | SN74LS194N | 2.20 |
| SN74LS31N | .39 | SN74LS181N | .39  | SN74LS195N | 2.20 |
| SN74LS32N | .39 | SN74LS182N | .39  | SN74LS196N | 2.20 |
| SN74LS33N | .39 | SN74LS183N | .39  | SN74LS197N | 2.20 |
| SN74LS34N | .39 | SN74LS184N | .39  | SN74LS198N | 2.20 |
| SN74LS35N | .39 | SN74LS185N | .39  | SN74LS199N | 2.20 |
| SN74LS36N | .39 | SN74LS186N | .39  | SN74LS200N | 2.20 |
| SN74LS37N | .39 | SN74LS187N | .39  | SN74LS201N | 2.20 |
| SN74LS38N | .39 | SN74LS188N | .39  | SN74LS202N | 2.20 |
| SN74LS39N | .39 | SN74LS189N | .39  | SN74LS203N | 2.20 |
| SN74LS40N | .39 | SN74LS190N | .39  | SN74LS204N | 2.20 |
| SN74LS41N | .39 | SN74LS191N | .39  | SN74LS205N | 2.20 |
| SN74LS42N | .39 | SN74LS192N | .39  | SN74LS206N | 2.20 |
| SN74LS43N | .39 | SN74LS193N | .39  | SN74LS207N | 2.20 |
| SN74LS44N | .39 | SN74LS194N | .39  | SN74LS208N | 2.20 |
| SN74LS45N | .39 | SN74LS195N | .39  | SN74LS209N | 2.20 |
| SN74LS46N | .39 | SN74LS196N | .39  | SN74LS210N | 2.20 |
| SN74LS47N | .39 | SN74LS197N | .39  | SN74LS211N | 2.20 |
| SN74LS48N | .39 | SN74LS198N | .39  | SN74LS212N | 2.20 |
| SN74LS49N | .39 | SN74LS199N | .39  | SN74LS213N | 2.20 |
| SN74LS50N | .39 | SN74LS200N | .39  | SN74LS214N | 2.20 |

**16K UPGRADE ONLY \$24.95 SPECIFY COMPUTER**

**hp HEWLETT PACKARD**

HP-85 \$2695.00

- HP 7225 Graphics Plotter \$1795.00
- HP 16K Memory Module \$265.00
- HP 5 1/4" Dual Master Flex Disk Drive 2100.00
- HP 5 1/4" Single Master Flex Disk Drive 1295.00
- HP Personality Module 700.00
- HP ROM Drawer 40.00
- HP Plotter/Printer ROM 130.00
- HP Input/Output ROM 260.00
- HP Matrix ROM 130.00
- HP Serial Interface (RS-232C) 350.00

**HP-83 \$1895.00**



# BULLET ELECTRONICS

P.O. BOX 401244R  
GARLAND, TX, 75040  
(214) 278-3553

## Sound Effects Kit \$18.50

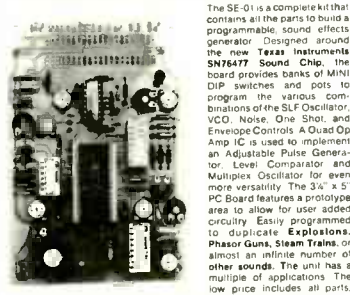

The SE-01 is a complete kit that contains all the parts to build a programmable sound effects generator. Designed around the new Texas Instruments SN76747 Sound Chip, the board provides banks of MINI DIP switches and pots to program the various combinations of the VLF Oscillator, VCO, Noise, One Shot, and Envelope Controls. A Quad Op Amp IC is used to implement an Adjustable Pulse Generator, Level Comparator and Multiplex Oscillator for even more versatility. The 3 1/2" x 5" PCB board features a prototype area to allow for user added circuitry. Easily programmed to duplicate Explosions, Phasors, Steam Trains, or almost an infinite number of other sounds. The unit has a multiple of applications. The low price includes all parts, assembly manual, programming charts, and detailed 76477 chip specifications. It runs on a 9V battery (not included). On board 100M $\Omega$  amp will drive a small speaker directly, or the unit can be connected to your stereo with incredible results! (Speaker not included). 76477 is included. Available separately for \$3.15 each.

## 7 Watt Audio Amp Kit \$6.95

SMALL, SINGLE HYBRID IC AND COMPONENTS FIT ON A 2" x 3" PCB BOARD (INCLUDED), RUNS ON 12VDC. GREAT FOR ANY PROJECT THAT NEEDS AN INEXPENSIVE AMP. LESS THAN 3% THD @ 5 WATTS. COMPATIBLE WITH SE-01 SOUND KIT.

## Doomsday Alarm Kit \$9.95

If you have trouble sleeping and you would like the rest of the neighborhood to share your misery then this little kit will be for you! There is no way to accurately describe the unearthly howls, screams and tones that come out of this kit. Four separate tone oscillators are mixed, cancelled and stepped at a varying rate. 10 Watts of crazy sounds. A great fun kit or a practical burglar alarm. Complete with PCB board and all necessary components less speaker. For 6-12 VDC. ORDER DA-02.

## New! 3TZ Time Zone Clock Kit

Microprocessor/ROM clock kit keeps local time (12 hour format), and 2 world time zones (24 hour format). Large 6" ORANGE readouts 10 min. ID timer for HAMS. Comes complete with attractive plastic case and wallplug XFMR.

- Quartz XTAL Timebase
- 3 Time Zones (Selectable)
- Feather-touch front panel switches
- Quartz XTAL Timebase
- 3 Time Zones (Selectable)
- Feather-touch front panel switches
- Quilted solder masked and plated PCB boards
- Seconds Reset/Hold feature

**\$54.40**

## SEE SPECIAL WINTER PRICES BELOW

### The Super Music Maker

REVISION 2  
**\$24.95**  
(Basic Kit)

Does not include speaker switches or 2708 ROM.

Now you can play hundreds of songs using the Bullet Super Music Maker. The unit features a single factory programmed microprocessor IC that comes with 20 pre-programmed short tunes. By adding the additional PROMS (2708's) the system can be expanded to play up to 1000 notes per PROM. Just think... a compact electronic instrument that will play dozens, hundreds or even thousands of selections of music. The kit comes with all electronic components (the PROM), and a drilled, plated and screened PCB Board which measures 4" x 4 1/2". The 7 watt amplifier section is on the same PCB board and drives an 8 ohm speaker (not included), from a whisper to ear splitting volume. Since the unit works on 12 VDC or 12 VAC, vehicle or portable operation is possible. What do you get for \$24.95? Everything but a speaker, transformer, case, switches, and PROM. Additional 2708 albums containing popular tunes are available for \$9.95 each or you can program your own PROMS using information provided with the kit instructions. Lists of available PROM albums are available on request. (Note: It is not possible to play chords or a melody with harmony simultaneously.)

- Envelope control gives decay to notes
- On board inverter allows single voltage (+12) operation

**OPTIONAL ACCESSORIES**

DIP Switches (One 8 pos., One 5 pos.) 2.00/each  
(Can be directly soldered to PCB Bd. to access lines)

Rotary Switch (8 position) 2.50/each  
(For remote wiring to PCB Bd. to access lines)

Attractive Tan Plastic Case 6.50  
Wallplug Transformer 3.00  
(For operation on 117VAC house voltage)

- SPECIAL WINTER PRICES**
- 1 Super Music Maker with case and two 5-position rotary switches **\$32.00**
  - 2 Super Music with one 2716 2K x 8 PROM filled with over 50 selections of additional music (1500 notes) **\$32.00**
  - 3 The Whole Bulk of Wait #2 - case and switches **\$39.95**

### ORDERING INFORMATION:

Call or Write For Free Catalog

- COD MINIMUM \$20.00 + ADD \$2.50 FOR COD'S
- UPS DELIVERY ADDRESS MUST ACCOMPANY ALL COD ORDERS
- \$1.00 HANDLING ON ORDERS UNDER \$10.00
- VISA, MC CASH ON DELIVERY
- ADD 6% FOR SHIPPING
- TEXAS RESIDENTS ADD 5% STATE SALES TAX
- ALL FOREIGN ORDERS ADD 25% FOR SHIPPING (CANADA 15% NO FOREIGN COD'S)
- CALL (214) 278-3553 TO PLACE CREDIT CARD OR COD ORDER

| MICROPROCESSORS | RAM             | MEMORY       | INTERFACE     |
|-----------------|-----------------|--------------|---------------|
| 7801P ACCESSORS | 4027 (250K)     | \$4.25       |               |
| M-10            | \$9.20          | 6809 \$23.50 | 2101 (256K)   |
| 2.80A           | 9.50            | 8080A 4.50   | 2102 (1024x1) |
| 6502            | 7.84            | 8085A 5.70   | 2112 (256Kx4) |
| 6800            | 7.50            | 8035 5.50    | 2114          |
| 6802            | 1.46            | 8085 25.21   | 2112 4.50     |
| 8080A           | SUPPORT DEVICES | 2147 (4Kx1)  | 6.64          |
| 6520            | \$6.65          | 8251 \$4.90  | MISC          |
| 6522            | 9.95            | 8253 7.50    | 8282          |
| 8212            | 2.25            | 8257 10.00   | 8286          |
| 8216            | 2.00            | 8259 11.50   |               |
| 8224            | 2.50            | 8275 32.00   |               |
| 8228            | 4.50            | 8279 7.20    |               |
| 8238            | 4.50            |              |               |
| 2708            | \$6.20          | 2758 \$12.50 |               |
| 2716            | 7.30            | 8748 37.70   |               |
| 2732            | 18.42           |              |               |

**16K RAM EXPANSION KIT**  
For TRS-80 (Model I or III), Apple II or PET computers  
Set (8 pcs. UP0416C-2 (2000s)) \$13.95  
Data furnished with purchase on request.

**MICROPROCESSOR INTERFACE IC'S**

|      |        |         |        |         |        |         |        |
|------|--------|---------|--------|---------|--------|---------|--------|
| 8720 | \$3.25 | 8796    | \$1.49 | 74LS242 | \$1.79 | 74LS245 | \$2.85 |
| 8726 | 2.15   | 8797    | 1.49   | 74LS243 | 1.79   | 74LS273 | 1.69   |
| 8728 | 2.30   | 74LS241 | 1.10   | 74LS244 | 1.10   | 74LS373 | 2.50   |
| 8795 | 1.49   |         |        |         |        |         |        |

**AMP SWITCHES**

|     |                    |        |     |                        |        |
|-----|--------------------|--------|-----|------------------------|--------|
| 925 | SPST 8 pos w/cover | \$4.99 | 958 | SPST 8 pos Low Profile | \$4.28 |
| 930 | DPST 4 pos w/cover | \$4.99 | 920 | SP 10 pos P.C. Rotary  | 7.81   |
| 932 | SPST 4 pos w/cover | 4.88   | 921 | 10 pos P.C. Rotary     | 6.81   |
| 933 | SPDT 4 pos w/cover | 8.02   | 927 | 16 pos Hex DIP Switch  | 4.28   |

**A.W. SPERRY INSTRUMENTS**

|         |                                       |          |
|---------|---------------------------------------|----------|
| E26100  | 3 1/2 Digit DMM with LCD Display      | \$140.95 |
| E26110  | 3 1/2 Digit DMM with LCD Display      | 159.95   |
| E26220  | 3 1/2 Digit DMM with LCD Display      | 122.95   |
| SP1000F | F.E.T. Input Volt-Ohm Milliammeter    | 105.95   |
| SP15    | Pocket Size Volt-Ohm Milliammeter     | 19.95    |
| SP80    | Extra Sensitive Volt-Ohm Milliammeter | 40.95    |

**WINCHESTER CONNECTORS AND CABLE**

|                                    |               |                |                |               |
|------------------------------------|---------------|----------------|----------------|---------------|
| HEADER CONNECTOR WITH EJECTOR      | 20 pin \$2.33 | 26 pin \$2.78  | 40 pin \$3.75  | 50 pin \$3.75 |
| RIGHT ANGLE CONNECTOR WITH EJECTOR | 20 pin \$1.70 | 26 pin \$2.49  | 34 pin \$3.13  | 50 pin \$3.75 |
| SOCKET CONNECTOR                   | 20 pin \$4.10 | 26 pin \$4.95  | 34 pin \$6.30  | 40 pin \$7.50 |
| RIBBON CABLE (Price per 10 feet)   | 20 pin \$5.00 | 25 pin \$ 6.30 | 26 pin \$ 6.45 | 34 pin \$8.30 |
|                                    | 37 pin \$9.50 | 40 pin \$10.00 | 50 pin \$13.00 |               |

**ITC CANNON CONNECTORS**

|                           |              |               |               |               |
|---------------------------|--------------|---------------|---------------|---------------|
| D-SUBMINIATURE CONNECTORS | DE-9P \$1.65 | DA-15S \$3.10 | DC-37P \$3.85 | DD-50P \$4.75 |
|                           | DE-9S 2.25   | DB-25P 2.85   | DC-37S 5.95   | DD-50S 7.95   |
|                           | DA-15P 2.40  | DB-25S 4.35   |               |               |

**GLOBAL SPECIALTIES CORP**

|               |                      |   |
|---------------|----------------------|---|
| LOGIC PROBES  | EXPERIMENTER SOCKETS | QUICK TEST SOLDERLESS BREADBOARD ELEMENTS |
| LP-1 \$5.00   | EXP-300 \$10.50      | QT-59S \$12.00                            |
| LP-2 \$8.00   | EXP-300PC 2.40       | QT-47S 9.50                               |
| LP-3 76.00    | EXP-350 6.10         | QT-35S 7.25                               |
| IC TEST CLIPS | PROTO-BOARD          | 4001 Pulse Generator \$235.00             |
| PC-14 \$4.50  | 100 4.00             | 5001 Universal Counter \$360.00           |
| PC-16 4.75    | PB-102 32.90         | Logic Monitor JUMPER                      |
| PC-24 10.00   | PB-101 26.00         | 100K Impedance WIRE KIT                   |
| PC-40 16.00   | PB-100 20.10         | LM-1 \$75.00                              |

**TECHNICAL DATA AND COMPUTER BOOKS**

An Intro to MP's (The Beginners' Book, \$7.95, An Intro to MP's (Basic Concepts), \$12.99, 4 and 8 Bit MP Handbooks \$19.95, 16 Bit MP Handbook \$19.95, The CRT Controller Handbook, \$6.99, The 68000 MP Handbook, \$6.99, 280 Assy Language Prog., \$16.99, 6502 Assy Language Prog., \$16.99, 6809 Assy Language Prog., \$16.99, Business System Buyer's Guide, \$7.95, CP/M User's Guide, \$12.99, Apple II User's Guide, \$15.00, MP's for Measurement & Control, \$15.99, CBASIC, Some Common BASIC Prog., \$14.99, Practical Basic Prog., \$15.99, Some Common BASIC Prog. - Atan Edition, \$14.99, Some Common BASIC Programs - TRS-80 Level II Edition, \$14.99, Science and Engineering Basic Prog. - Apple II Edition, \$15.99, TTL Cook Book, \$11.95, TV Typewriter Cook Book, \$11.95, CMOS Cook Book, \$12.95, 2-16195, Handbook, \$11.95, Using the 6800 MP, \$8.95, The Cheap Video Card Book, \$7.95, I.C. Converter Cook Book, \$13.95, The 555 Timer Appl's Source Book, \$7.95, TRS-80 Interfacing Book 1, \$10.95, TRS-80 Interfacing Book 2, \$11.95, MP Primer and Interfacing the 6502, \$15.95, 8085A Cook Book, \$13.95, MP Primer (2nd Edition), \$14.50, 2-80 MP Design Projects, \$13.95, IC Op-Amp Cook Book, \$12.95, 2-80 MP Guidebook To Small Computers, \$6.95, Memory BASIC Appl's for Your TRS-80, \$12.95, Circuit Design Prog. for the TRS-80, \$14.50, Mostly BASIC Appl's for Your Apple II, \$12.95, Mostly BASIC Appl's for Your PET, \$12.95, CP/M Primer, \$14.95, The S-100 and Other Micro Buses (2nd Edition), \$9.95, Your Own Computer, \$7.95, Applesoft Language, \$10.95

**LED DISPLAYS**

|        |       |  |         |         |        |         |        |
|--------|-------|--|---------|---------|--------|---------|--------|
| FNDS37 | 1.50  | FNDS80   | 1.95    | MAN6410 | \$2.10 | MAN670  | \$3.10 |
| FNDS50 | 1.50  | MAN3620  | 2.00    | MAN6640 | 4.10   | MAN6750 | 2.90   |
| TIL311 | 27.19 | Visible Red Hex Display w/integral logic on chip | \$10.26 |         |        |         |        |

**LINEAR DEVICES**

|        |      |        |        |         |      |        |        |
|--------|------|--------|--------|---------|------|--------|--------|
| LM301N | 32   | LM384N | \$1.75 | LM723N  | 45   | 7812C  | \$1.60 |
| LM309N | 2.00 | LM386N | 1.10   | LM741N  | 35   | 7815C  | 1.60   |
| LM310N | 1.75 | NE555N | 36     | LM747N  | 55   | MC1310 | 2.47   |
| LM317N | 1.15 | NE568N | 70     | LM1458N | 40   | MC1342 | 1.31   |
| LM318N | 1.95 | NE569N | 36     | LM153N  | 85   | MC1350 | 1.80   |
| LM319N | 1.65 | NE566N | 1.65   | LM1498N | 80   | MC1330 | 2.50   |
| LM380N | 50   | NE571N | 85     | 7805CT  | 1.60 | MC1358 | 2.10   |

**LOW POWER SCHOTTKY TTL**

|        |       |         |       |          |      |         |       |
|--------|-------|---------|-------|----------|------|---------|-------|
| 74LS00 | \$ 22 | 74LS44  | \$ 50 | 74LS136S | 35   | 74LS195 | \$ 60 |
| 74LS01 | 22    | 74LS47  | 80    | 74LS138  | 55   | 74LS196 | 80    |
| 74LS02 | 22    | 74LS54  | 30    | 74LS151  | 55   | 74LS244 | 11.10 |
| 74LS04 | 25    | 74LS75  | 35    | 74LS153  | 55   | 74LS244 | 11.10 |
| 74LS08 | 25    | 74LS76  | 35    | 74LS156  | 50   | 74LS248 | 90    |
| 74LS10 | 25    | 74LS83  | 60    | 74LS158  | 50   | 74LS257 | 55    |
| 74LS11 | 30    | 74LS86  | 35    | 74LS161  | 70   | 74LS266 | 65    |
| 74LS12 | 30    | 74LS92  | 50    | 74LS163  | 70   | 74LS283 | 65    |
| 74LS20 | 25    | 74LS96  | 70    | 74LS168  | 2.10 | 74LS285 | 85    |
| 74LS21 | 30    | 74LS112 | 40    | 74LS169  | 95   | 74LS352 | 1.00  |
| 74LS28 | 30    | 74LS122 | 40    | 74LS174  | 60   | 74LS366 | 45    |
| 74LS28 | 45    | 74LS123 | 70    | 74LS181  | 1.85 | 74LS368 | 45    |
| 74LS32 | 30    | 74LS125 | 45    | 74LS193  | 75   | 74LS399 | 1.20  |
| 74LS38 | 40    | 74LS132 | 65    | 74LS194  | 60   | 74LS395 | 1.20  |

**5% Carbon Film Resistors**  
1/4W 10 for 40c  
1/2W 10 for 50c

**WE ALSO STOCK**  
TTL • CMOS • LINEAR • DIP SOCKETS • EDGE CONNECTORS • SPRAGUE CAPACITORS & SWITCHES • E-Z HOOK TEST ACCESSORIES

**SUNTRONICS CO., INC.**  
12621 CRENSHAW BOULEVARD  
HAWTHORNE, CALIFORNIA 90250  
(LOCATED NEXT TO FORMULA INTERNATIONAL)  
STORE HOURS: Mon.-Fri. 10am to 6:30pm - Sat. 10am to 5pm  
IN CALIFORNIA OUTSIDE CALIFORNIA TOLL FREE  
(213) 644-1149 1-800-421-5775  
Mail Order - Minimum Order: \$10. Send Money Order or Check to: P.O. BOX 1957 - Dept. R, HAWTHORNE, CA 90250. Use your VISA or Mastercard (please include expiration date). Add \$2.00 postage and handling to order. California residents add 6% sales tax.  
★ OUR NEW 1982 CATALOG AVAILABLE ON REQUEST ★

**INTRODUCING OUR NEW LINE OF HITECH KITS**

Our Electronic Kits are educational in nature, fun to build and enjoyable to play. Each kit comes with complete documentation, which includes schematic diagrams, parts list and component layout picture. A circuit theory section is also included to help the builder understand the circuit operation.

**O-50V 3A Regulated Adjustable Power Supply**  
With overload protection and LED power on indicator. Assem \$28.50  
HKIT-503 Kit \$24.50

**30W Single Channel Power Amp.**  
Compact power amp. with volume, treble and base control. Excellent for boosting the power of your portable radio, or cassette. Connect to your TV audio and experience the real sound of your TV program.  
HKIT-300 Assembled \$19.95 Kit \$16.95

**Programmable Music Door-bell**  
Electronic door-bell that has 9 programmable tones. Uses CMOS for low power consumption and has auto shut-off feature.  
HKIT-47A Assembled \$16.50 Kit \$14.50

**5 Function LCD Pen Watch**  
High Quality ball point pen with built-in 5 function LCD watch. Comes as finished product only with gift box. \$9.99

**Electronic Chinese Dice**  
A 3 dice game kit. All kinds of combinations. Fun. Assem \$28.50  
HKIT-31 Kit \$24.50

**18V 10A Power Supply**  
Designed for your special power requirement. Has current limit, auto volts, and current. Uses dual power trans. Excellent for CB or power charger.  
HKIT-1810 Assem \$39.50 Kit \$29.50

**LED Stereo Level Meter**  
LSI circuitry w/peak hold and auto reset. -15 to +2 dB range. 1-200V input w/sens. adj. Works w/car Batt input w/sens. adj. Kit \$29.95  
HKIT-33 Assem \$33.90 Kit \$29.95

**Electronic Wheel of Fortune**  
A fun game that uses CMOS circuit and LED's to simulate a real Wheel of Fortune. Easy to assemble.  
HKIT-8 Assem \$10.50. Kit \$8.50  
Kits do not include xformer/batt./case

**Many more items available. Please see Ad in next issue or WRITE FOR CATALOG**

To Order, send check or money order to:  
**Hitech Electronics**  
4425 W. Sepulveda Blvd., Torrance CA 90505  
Phone Orders: (213) 371-2160  
VISA and MC welcomed.  
Shipping and Handling \$2.00. CA resident add 6% tax.  
**PLEASE VISIT OUR STORE.** Open 10:00-8:00 Mon. thru Sat.  
Special discounts available to educational institutions. Dealer inquiries invited.

**ELECTRONIC KITS FROM HAL-TRONIX**

2304 MHZ DOWN CONVERTERS. TUNES IN ON CHANNELS 2 TO 7 ON YOUR OWN HOME T.V. HAS FREQUENCY RANGE FROM 2000 MHZ TO 2500 MHZ. EASY TO CONSTRUCT AND COMES COMPLETE WITH ALL PARTS INCLUDING A DIE-CAST ALUM CASE AND COAX FITTINGS, REQUIRE A VARIABLE POWER SUPPLY AND ANTENNA (Antenna can be a dish type or coffee can type depending on the signal strength in your area.)

2304 MOD 1 (Basic Kit) \$49.95  
(Less case & fittings)

2304 MOD 2 (Basic / Pre-amp) \$59.95  
(includes case & fittings)

2304 MOD 3 (Hi-Gain Pre-amp) \$69.95  
(includes case & fittings)

POWER SUPPLY FOR EITHER MODEL ABOVE IS AVAILABLE. COMES COMPLETE WITH ALL PARTS, CASE, TRANSFORMER, ANTENNA SWITCH AND CONNECTORS (Kit) \$24.95  
Slotted Microwave Antenna For Above Downverters.....\$39.95

**PREAMPLIFIERS**

HAL PA-19—1.5 mhz to 150 mhz. 19db gain operates on 8 to 18 volts at 10ma. Complete unit \$8.95.  
HAL PA-14—3 mhz to 1.4 ghz. 10 to 12 db gain operates on 8 to 18 volts at 10ma. Complete unit \$12.95.  
(The above units are ideal for receivers, counters, etc.)

16 LINE TOUCH TONE DECODER KIT WITH P.C. BOARD AND PARTS .....\$69.95

12 LINE TOUCH TONE DECODER KIT WITH P.C. BOARD AND PARTS .....\$39.95

16 LINE ENCODER KIT, COMPLETE WITH CASE, PAD AND COMPONENTS ....\$39.95

12 LINE ENCODER KIT, COMPLETE WITH CASE, PAD AND COMPONENTS ....\$29.95

**MANY, MANY OTHER KITS AVAILABLE**

Send 20 cents stamp or S.A.S.E. for information and flyer on other HAL-TRONIX products. To order by phone: 1-315-251-1782

**HAL-TRONIX**  
P.O. Box 1101  
Southgate, MI 48195

ORDERS OVER \$25.00 WILL BE SHIPPED POSTPAID EXCEPT ON ITEMS WHERE ADDITIONAL CHARGES ARE REQUIRED. ON ORDERS LESS THAN \$25.00 PLEASE INCLUDE ADDITIONAL \$2.00 FOR HANDLING AND MAILING CHARGES.

RADIO-ELECTRONICS



**ramsey**

# the first name in Counters !



## 9 DIGITS 600 MHz \$129<sup>95</sup> WIRED

**PRICES:**  
 CT-90 wired, 1 year warranty \$129.95  
 CT-90 Kit, 90 day parts warranty 109.95  
 AC-1 AC adapter 3.95  
 BP-1 Nicad pack + AC Adapter/Charger 12.95  
 OV-1, Micro power Oven time base 49.95  
 External time base input 14.95

The CT-90 is the most versatile, feature packed counter available for less than \$300.00! Advanced design features include: three selectable gate times, nine digits, gate indicator and a unique display hold function which holds the displayed count after the input signal is removed! Also, a 10MHz TCXO time base is used which enables easy zero beat calibration checks against WWV. Optionally, an internal nicad battery pack, external time base input and Micro-power high stability crystal oven time base are available. The CT-90, performance you can count on!

**SPECIFICATIONS:**

Range: 20 Hz to 600 MHz  
 Sensitivity: Less than 10 MV to 150 MHz  
 Less than 50 MV to 500 MHz  
 Resolution: 0.1 Hz (10 MHz range)  
 1.0 Hz (60 MHz range)  
 10.0 Hz (600 MHz range)  
 Display: 9 digits 0.4" LED  
 Time base: Standard-10,000 mHz, 1.0 ppm 20-40°C.  
 Optional Micro-power oven-0.1 ppm 20-40°C  
 Power: 8-15 VAC @ 250 ma

## 7 DIGITS 525 MHz \$99<sup>95</sup> WIRED



**SPECIFICATIONS:**

Range: 20 Hz to 525 MHz  
 Sensitivity: Less than 50 MV to 150 MHz  
 Less than 150 MV to 500 MHz  
 Resolution: 1.0 Hz (5 MHz range)  
 10.0 Hz (50 MHz range)  
 100.0 Hz (500 MHz range)  
 Display: 7 digits 0.4" LED  
 Time base: 1.0 ppm TCXO 20-40°C  
 Power: 12 VAC @ 250 ma

The CT-70 breaks the price barrier on lab quality frequency counters. Deluxe features such as; three frequency ranges - each with pre-amplification, dual selectable gate times, and gate activity indication make measurements a snap. The wide frequency range enables you to accurately measure signals from audio thru UHF with 1.0 ppm accuracy - that's .0001%! The CT-70 is the answer to all your measurement needs, in the field, lab or ham shack.

**PRICES:**

CT-70 wired, 1 year warranty \$99.95  
 CT-70 Kit, 90 day parts warranty 84.95  
 AC-1 AC adapter 3.95  
 BP-1 Nicad pack + AC adapter/charger 12.95

## 7 DIGITS 500 MHz \$79<sup>95</sup> WIRED



**PRICES:**

MINI-100 wired, 1 year warranty \$79.95  
 AC-Z Ac adapter for MINI-100 3.95  
 BP-Z Nicad pack and AC adapter/charger 12.95

Here's a handy, general purpose counter that provides most counter functions at an unbelievable price. The MINI-100 doesn't have the full frequency range or input impedance qualities found in higher price units, but for basic RF signal measurements, it can't be beat! Accurate measurements can be made from 1 MHz all the way up to 500 MHz with excellent sensitivity throughout the range, and the two gate times let you select the resolution desired. Add the nicad pack option and the MINI-100 makes an ideal addition to your tool box for "in-the-field" frequency checks and repairs.

**SPECIFICATIONS:**

Range: 1 MHz to 500 MHz  
 Sensitivity: Less than 25 MV  
 Resolution: 100 Hz (slow gate)  
 1.0 KHz (fast gate)  
 Display: 7 digits, 0.4" LED  
 Time base: 2.0 ppm 20-40°C  
 Power: 5 VDC @ 200 ma

## 8 DIGITS 600 MHz \$159<sup>95</sup> WIRED



**SPECIFICATIONS:**

Range: 20 Hz to 600 MHz  
 Sensitivity: Less than 25 mv to 150 MHz  
 Less than 150 mv to 600 MHz  
 Resolution: 1.0 Hz (60 MHz range)  
 10.0 Hz (600 MHz range)  
 Display: 8 digits 0.4" LED  
 Time base: 2.0 ppm 20-40°C  
 Power: 110 VAC or 12 VDC

The CT-50 is a versatile lab bench counter that will measure up to 600 MHz with 8 digit precision. And, one of its best features is the Receive Frequency Adapter, which turns the CT-50 into a digital readout for any receiver. The adapter is easily programmed for any receiver and a simple connection to the receiver's VFO is all that is required for use. Adding the receiver adapter in no way limits the operation of the CT-50, the adapter can be conveniently switched on or off. The CT-50, a counter that can work double-duty!

**PRICES:**

CT-50 wired, 1 year warranty \$159.95  
 CT-50 Kit, 90 day parts warranty 119.95  
 RA-1, receiver adapter kit 14.95  
 RA-1 wired and pre-programmed (send copy of receiver schematic) 29.95

## DIGITAL MULTIMETER \$99<sup>95</sup> WIRED



**PRICES:**

DM-700 wired, 1 year warranty \$99.95  
 DM-700 Kit, 90 day parts warranty 79.95  
 AC-1, AC adaptor 3.95  
 BP-3, Nicad pack + AC adapter/charger 19.95  
 MP-1, Probe kit 2.95

The DM-700 offers professional quality performance at a hobbyist price. Features include: 26 different ranges and 5 functions, all arranged in a convenient, easy to use format. Measurements are displayed on a large 3 1/2 digit, 1/2 inch LED readout with automatic decimal placement, automatic polarity, overrange indication and overload protection up to 1250 volts on all ranges, making it virtually goof-proof! The DM-700 looks great, a handsome, jet black, rugged ABS case with convenient retractable tilt bail makes it an ideal addition to any shop.

**SPECIFICATIONS:**

DC/AC volts: 100uV to 1 KV, 5 ranges  
 DC/AC current: 0.1uA to 2.0 Amps, 5 ranges  
 Resistance: 0.1 ohms to 20 Megohms, 6 ranges  
 Input impedance: 10 Megohms, DC/AC volts  
 Accuracy: 0.1% basic DC volts  
 Power: 4 'C' cells

### AUDIO SCALER

For high resolution audio measurements, multiplies UP in frequency.

- Great for PL tones
- Multiplies by 10 or 100
- 0.01 Hz resolution

\$29.95 Kit \$39.95 Wired

### ACCESSORIES

Telescopic whip antenna - BNC plug ..... \$ 7.95  
 High impedance probe, light loading ..... 15.95  
 Low pass probe, for audio measurements ..... 15.95  
 Direct probe, general purpose usage ..... 12.95  
 Tilt bail, for CT 70, 90, MINI-100 ..... 3.95  
 Color burst calibration unit, calibrates counter against color TV signal ..... 14.95

### COUNTER PREAMP

For measuring extremely weak signals from 10 to 1,000 MHz. Small size, powered by plug transformer-included.

- Flat 25 db gain
  - BNC Connectors
  - Great for sniffing RF with pick-up loop
- \$34.95 Kit \$44.95 Wired

**ramsey electronics, inc.**  
 2575 BAIRD RD. • PENFIELD, NY 14526

PHONE ORDERS  
 CALL 716-586-3950

**TERMS**

Satisfaction guaranteed - examine for 10 days, if not pleased, return in original form for refund. Add 5% for shipping - insurance to a maximum of \$10. Overseas add 15% COD, add \$2. Orders under \$10. add \$1.50. NY residents add 7% tax.

CIRCLE 6 ON FREE INFORMATION CARD













\*\*TV BOX BUILDERS\*\*

Table listing TV box components and prices: Sanyo UHF Varactor Tuner \$34.95, Transformer 9 & 16.5V @ 1A \$3.45, LM 7812 \$1.35, LM 7815 \$1.15, LM1800 \$2.45, LM1889 \$2.75, LM 301 \$1.90, LM 1458 \$1.00, LM 380 \$1.90, NE 565 \$1.90, MC1330 \$2.40, MC1350 \$1.90, MC1358 \$2.10, 74123 \$1.80

Simple Simon was simple - But this one is a SNAP\* ONLY \$109.95. PRICE INCLUDES: I.C.s/Resistors/Capacitors/Variable Resistors/Trim Cap/Coils/Transformer Diodes/Regulator/Sony Varactor Tuner. Plus you get a FREE Drilled & Etched 4 1/2 x 5 Printed Circuit Board w/assembly.

Instructions with each \$109.95 order. WALL TRANSFORMER 17V.A.C. - 7.5V.A. with 6 ft. cord \$4.45

CH3/CH4 Modulator \$1795. Image of the modulator unit.

MICRO PROCESSOR IC's. Z80 CPU \$5.75, Z80 SIO/I \$10.95, Z80 DMA \$10.95, Z80 PIO \$5.00, D2716-6 Intel \$3.25, D2708 \$2.75. Image of a Z80 CPU chip.

EPROM'S. C1702A 2K 1US \$7.50, C2708 1K x 8 450 ns \$3.50, C2716/1MS2516 (Intel version) \$4.75, 16K 450NS Single 5V Supply \$4.75, TMS2532 (T I Pin Out) \$14.95, 32K (4096 x 8) 450 ns \$69.95, TMS2546 64K (8K x 8) 450 ns \$69.95. Image of an EPROM chip.

HMR II\* 6 MO. WARRANTY. HAM MICROWAVE RECEIVER w/Cable & Power Supply \$149.95. Image of the microwave receiver.

ORDERING INSTRUCTIONS. Minimum order \$10.00. C.O.D. Payment by cash or money order, company check. C.O.D. - \$2.25 + \$2.35 shipping. CREDIT CARDS - Master Charge & Visa. SHIPPING MINIMUM \$2.35 + 35c per \$100.00 for insurance. \*We do not sell these items for the use of receiving subscription type TV transmissions.

CPU'S & SUPPORT CHIPS

Table of CPU and support chips: 8080, 8085, AMD2801, 8027, 8251, 8252, 8253, 8254, 8255, 8256, 8257, 8258, 8259, 8260, 8261, 8262, 8263, 8264, 8265, 8266, 8267, 8268, 8269, 8270, 8271, 8272, 8273, 8274, 8275, 8276, 8277, 8278, 8279, 8280, 8281, 8282, 8283, 8284, 8285, 8286, 8287, 8288, 8289, 8290, 8291, 8292, 8293, 8294, 8295, 8296, 8297, 8298, 8299, 8300, 8301, 8302, 8303, 8304, 8305, 8306, 8307, 8308, 8309, 8310, 8311, 8312, 8313, 8314, 8315, 8316, 8317, 8318, 8319, 8320, 8321, 8322, 8323, 8324, 8325, 8326, 8327, 8328, 8329, 8330, 8331, 8332, 8333, 8334, 8335, 8336, 8337, 8338, 8339, 8340, 8341, 8342, 8343, 8344, 8345, 8346, 8347, 8348, 8349, 8350, 8351, 8352, 8353, 8354, 8355, 8356, 8357, 8358, 8359, 8360, 8361, 8362, 8363, 8364, 8365, 8366, 8367, 8368, 8369, 8370, 8371, 8372, 8373, 8374, 8375, 8376, 8377, 8378, 8379, 8380, 8381, 8382, 8383, 8384, 8385, 8386, 8387, 8388, 8389, 8390, 8391, 8392, 8393, 8394, 8395, 8396, 8397, 8398, 8399, 8400, 8401, 8402, 8403, 8404, 8405, 8406, 8407, 8408, 8409, 8410, 8411, 8412, 8413, 8414, 8415, 8416, 8417, 8418, 8419, 8420, 8421, 8422, 8423, 8424, 8425, 8426, 8427, 8428, 8429, 8430, 8431, 8432, 8433, 8434, 8435, 8436, 8437, 8438, 8439, 8440, 8441, 8442, 8443, 8444, 8445, 8446, 8447, 8448, 8449, 8450, 8451, 8452, 8453, 8454, 8455, 8456, 8457, 8458, 8459, 8460, 8461, 8462, 8463, 8464, 8465, 8466, 8467, 8468, 8469, 8470, 8471, 8472, 8473, 8474, 8475, 8476, 8477, 8478, 8479, 8480, 8481, 8482, 8483, 8484, 8485, 8486, 8487, 8488, 8489, 8490, 8491, 8492, 8493, 8494, 8495, 8496, 8497, 8498, 8499, 8500, 8501, 8502, 8503, 8504, 8505, 8506, 8507, 8508, 8509, 8510, 8511, 8512, 8513, 8514, 8515, 8516, 8517, 8518, 8519, 8520, 8521, 8522, 8523, 8524, 8525, 8526, 8527, 8528, 8529, 8530, 8531, 8532, 8533, 8534, 8535, 8536, 8537, 8538, 8539, 8540, 8541, 8542, 8543, 8544, 8545, 8546, 8547, 8548, 8549, 8550, 8551, 8552, 8553, 8554, 8555, 8556, 8557, 8558, 8559, 8560, 8561, 8562, 8563, 8564, 8565, 8566, 8567, 8568, 8569, 8570, 8571, 8572, 8573, 8574, 8575, 8576, 8577, 8578, 8579, 8580, 8581, 8582, 8583, 8584, 8585, 8586, 8587, 8588, 8589, 8590, 8591, 8592, 8593, 8594, 8595, 8596, 8597, 8598, 8599, 8600, 8601, 8602, 8603, 8604, 8605, 8606, 8607, 8608, 8609, 8610, 8611, 8612, 8613, 8614, 8615, 8616, 8617, 8618, 8619, 8620, 8621, 8622, 8623, 8624, 8625, 8626, 8627, 8628, 8629, 8630, 8631, 8632, 8633, 8634, 8635, 8636, 8637, 8638, 8639, 8640, 8641, 8642, 8643, 8644, 8645, 8646, 8647, 8648, 8649, 8650, 8651, 8652, 8653, 8654, 8655, 8656, 8657, 8658, 8659, 8660, 8661, 8662, 8663, 8664, 8665, 8666, 8667, 8668, 8669, 8670, 8671, 8672, 8673, 8674, 8675, 8676, 8677, 8678, 8679, 8680, 8681, 8682, 8683, 8684, 8685, 8686, 8687, 8688, 8689, 8690, 8691, 8692, 8693, 8694, 8695, 8696, 8697, 8698, 8699, 8700, 8701, 8702, 8703, 8704, 8705, 8706, 8707, 8708, 8709, 8710, 8711, 8712, 8713, 8714, 8715, 8716, 8717, 8718, 8719, 8720, 8721, 8722, 8723, 8724, 8725, 8726, 8727, 8728, 8729, 8730, 8731, 8732, 8733, 8734, 8735, 8736, 8737, 8738, 8739, 8740, 8741, 8742, 8743, 8744, 8745, 8746, 8747, 8748, 8749, 8750, 8751, 8752, 8753, 8754, 8755, 8756, 8757, 8758, 8759, 8760, 8761, 8762, 8763, 8764, 8765, 8766, 8767, 8768, 8769, 8770, 8771, 8772, 8773, 8774, 8775, 8776, 8777, 8778, 8779, 8780, 8781, 8782, 8783, 8784, 8785, 8786, 8787, 8788, 8789, 8790, 8791, 8792, 8793, 8794, 8795, 8796, 8797, 8798, 8799, 8800, 8801, 8802, 8803, 8804, 8805, 8806, 8807, 8808, 8809, 8810, 8811, 8812, 8813, 8814, 8815, 8816, 8817, 8818, 8819, 8820, 8821, 8822, 8823, 8824, 8825, 8826, 8827, 8828, 8829, 8830, 8831, 8832, 8833, 8834, 8835, 8836, 8837, 8838, 8839, 8840, 8841, 8842, 8843, 8844, 8845, 8846, 8847, 8848, 8849, 8850, 8851, 8852, 8853, 8854, 8855, 8856, 8857, 8858, 8859, 8860, 8861, 8862, 8863, 8864, 8865, 8866, 8867, 8868, 8869, 8870, 8871, 8872, 8873, 8874, 8875, 8876, 8877, 8878, 8879, 8880, 8881, 8882, 8883, 8884, 8885, 8886, 8887, 8888, 8889, 8890, 8891, 8892, 8893, 8894, 8895, 8896, 8897, 8898, 8899, 8900, 8901, 8902, 8903, 8904, 8905, 8906, 8907, 8908, 8909, 8910, 8911, 8912, 8913, 8914, 8915, 8916, 8917, 8918, 8919, 8920, 8921, 8922, 8923, 8924, 8925, 8926, 8927, 8928, 8929, 8930, 8931, 8932, 8933, 8934, 8935, 8936, 8937, 8938, 8939, 8940, 8941, 8942, 8943, 8944, 8945, 8946, 8947, 8948, 8949, 8950, 8951, 8952, 8953, 8954, 8955, 8956, 8957, 8958, 8959, 8960, 8961, 8962, 8963, 8964, 8965, 8966, 8967, 8968, 8969, 8970, 8971, 8972, 8973, 8974, 8975, 8976, 8977, 8978, 8979, 8980, 8981, 8982, 8983, 8984, 8985, 8986, 8987, 8988, 8989, 8990, 8991, 8992, 8993, 8994, 8995, 8996, 8997, 8998, 8999, 9000, 9001, 9002, 9003, 9004, 9005, 9006, 9007, 9008, 9009, 9010, 9011, 9012, 9013, 9014, 9015, 9016, 9017, 9018, 9019, 9020, 9021, 9022, 9023, 9024, 9025, 9026, 9027, 9028, 9029, 9030, 9031, 9032, 9033, 9034, 9035, 9036, 9037, 9038, 9039, 9040, 9041, 9042, 9043, 9044, 9045, 9046, 9047, 9048, 9049, 9050, 9051, 9052, 9053, 9054, 9055, 9056, 9057, 9058, 9059, 9060, 9061, 9062, 9063, 9064, 9065, 9066, 9067, 9068, 9069, 9070, 9071, 9072, 9073, 9074, 9075, 9076, 9077, 9078, 9079, 9080, 9081, 9082, 9083, 9084, 9085, 9086, 9087, 9088, 9089, 9090, 9091, 9092, 9093, 9094, 9095, 9096, 9097, 9098, 9099, 9100, 9101, 9102, 9103, 9104, 9105, 9106, 9107, 9108, 9109, 9110, 9111, 9112, 9113, 9114, 9115, 9116, 9117, 9118, 9119, 9120, 9121, 9122, 9123, 9124, 9125, 9126, 9127, 9128, 9129, 9130, 9131, 9132, 9133, 9134, 9135, 9136, 9137, 9138, 9139, 9140, 9141, 9142, 9143, 9144, 9145, 9146, 9147, 9148, 9149, 9150, 9151, 9152, 9153, 9154, 9155, 9156, 9157, 9158, 9159, 9160, 9161, 9162, 9163, 9164, 9165, 9166, 9167, 9168, 9169, 9170, 9171, 9172, 9173, 9174, 9175, 9176, 9177, 9178, 9179, 9180, 9181, 9182, 9183, 9184, 9185, 9186, 9187, 9188, 9189, 9190, 9191, 9192, 9193, 9194, 9195, 9196, 9197, 9198, 9199, 9200, 9201, 9202, 9203, 9204, 9205, 9206, 9207, 9208, 9209, 9210, 9211, 9212, 9213, 9214, 9215, 9216, 9217, 9218, 9219, 9220, 9221, 9222, 9223, 9224, 9225, 9226, 9227, 9228, 9229, 9230, 9231, 9232, 9233, 9234, 9235, 9236, 9237, 9238, 9239, 9240, 9241, 9242, 9243, 9244, 9245, 9246, 9247, 9248, 9249, 9250, 9251, 9252, 9253, 9254, 9255, 9256, 9257, 9258, 9259, 9260, 9261, 9262, 9263, 9264, 9265, 9266, 9267, 9268, 9269, 9270, 9271, 9272, 9273, 9274, 9275, 9276, 9277, 9278, 9279, 9280, 9281, 9282, 9283, 9284, 9285, 9286, 9287, 9288, 9289, 9290, 9291, 9292, 9293, 9294, 9295, 9296, 9297, 9298, 9299, 9300, 9301, 9302, 9303, 9304, 9305, 9306, 9307, 9308, 9309, 9310, 9311, 9312, 9313, 9314, 9315, 9316, 9317, 9318, 9319, 9320, 9321, 9322, 9323, 9324, 9325, 9326, 9327, 9328, 9329, 9330, 9331, 9332, 9333, 9334, 9335, 9336, 9337, 9338, 9339, 9340, 9341, 9342, 9343, 9344, 9345, 9346, 9347, 9348, 9349, 9350, 9351, 9352, 9353, 9354, 9355, 9356, 9357, 9358, 9359, 9360, 9361, 9362, 9363, 9364, 9365, 9366, 9367, 9368, 9369, 9370, 9371, 9372, 9373, 9374, 9375, 9376, 9377, 9378, 9379, 9380, 9381, 9382, 9383, 9384, 9385, 9386, 9387, 9388, 9389, 9390, 9391, 9392, 9393, 9394, 9395, 9396, 9397, 9398, 9399, 9400, 9401, 9402, 9403, 9404, 9405, 9406, 9407, 9408, 9409, 9410, 9411, 9412, 9413, 9414, 9415, 9416, 9417, 9418, 9419, 9420, 9421, 9422, 9423, 9424, 9425, 9426, 9427, 9428, 9429, 9430, 9431, 9432, 9433, 9434, 9435, 9436, 9437, 9438, 9439, 9440, 9441, 9442, 9443, 9444, 9445, 9446, 9447, 9448, 9449, 9450, 9451, 9452, 9453, 9454, 9455, 9456, 9457, 9458, 9459, 9460, 9461, 9462, 9463, 9464, 9465, 9466, 9467, 9468, 9469, 9470, 9471, 9472, 9473, 9474, 9475, 9476, 9477, 9478, 9479, 9480, 9481, 9482, 9483, 9484, 9485, 9486, 9487, 9488, 9489, 9490, 9491, 9492, 9493, 9494, 9495, 9496, 9497, 9498, 9499, 9500, 9501, 9502, 9503, 9504, 9505, 9506, 9507, 9508, 9509, 9510, 9511, 9512, 9513, 9514, 9515, 9516, 9517, 9518, 9519, 9520, 9521, 9522, 9523, 9524, 9525, 9526, 9527, 9528, 9529, 9530, 9531, 9532, 9533, 9534, 9535, 9536, 9537, 9538, 9539, 9540, 9541, 9542, 9543, 9544, 9545, 9546, 9547, 9548, 9549, 9550, 9551, 9552, 9553, 9554, 9555, 9556, 9557, 9558, 9559, 9560, 9561, 9562, 9563, 9564, 9565, 9566, 9567, 9568, 9569, 9570, 9571, 9572, 9573, 9574, 9575, 9576, 9577, 9578, 9579, 9580, 9581, 9582, 9583, 9584, 9585, 9586, 9587, 9588, 9589, 9590, 9591, 9592, 9593, 9594, 9595, 9596, 9597, 9598, 9599, 9600, 9601, 9602, 9603, 9604, 9605, 9606, 9607, 9608, 9609, 9610, 9611, 9612, 9613, 9614, 9615, 9616, 9617, 9618, 9619, 9620, 9621, 9622, 9623, 9624, 9625, 9626, 9627, 9628, 9629, 9630, 9631, 9632, 9633, 9634, 9635, 9636, 9637, 9638, 9639, 9640, 9641, 9642, 9643, 9644, 9645, 9646, 9647, 9648, 9649, 9650, 9651, 9652, 9653, 9654, 9655, 9656, 9657, 9658, 9659, 9660, 9661, 9662, 9663, 9664, 9665, 9666, 9667, 9668, 9669, 9670, 9671, 9672, 9673, 9674, 9675, 9676, 9677, 9678, 9679, 9680, 9681, 9682, 9683, 9684, 9685, 9686, 9687, 9688, 9689, 9690, 9691, 9692, 9693, 9694, 9695, 9696, 9697, 9698, 9699, 9700, 9701, 9702, 9703, 9704, 9705, 9706, 9707, 9708, 9709, 9710, 9711, 9712, 9713, 9714, 9715, 9716, 9717, 9718, 9719, 9720, 9721, 9722, 9723, 9724, 9725, 9726, 9727, 9728, 9729, 9730, 9731, 9732, 9733, 9734, 9735, 9736, 9737, 9738, 9739, 9740, 9741, 9742, 9743, 9744, 9745, 9746, 9747, 9748, 9749, 9750, 9751, 9752, 9753, 9754, 9755, 9756, 9757, 9758, 9759, 9760, 9761, 9762, 9763, 9764, 9765, 9766, 9767, 9768, 9769, 9770, 9771, 9772, 9773, 9774, 9775, 9776, 9777, 9778, 9779, 9780, 9781, 9782, 9783, 9784, 9785, 9786, 9787, 9788, 9789, 9790, 9791, 9792, 9793, 9794, 9795, 9796, 9797, 9798, 9799, 9800, 9801, 9802, 9803, 9804, 9805, 9806, 9807, 9808, 9809, 9810, 9811, 9812, 9813, 9814, 9815, 9816, 9817, 9818, 9819, 9820, 9821, 9822, 9823, 9824, 9825, 9826, 9827, 9828, 9829, 9830, 9831, 9832, 9833, 9834, 9835, 9836, 9837, 9838, 9839, 9840, 9841, 9842, 9843, 9844, 9845, 9846, 9847, 9848, 9849, 9850, 9851, 9852, 9853, 9854, 9855, 9856, 9857, 9858, 9859, 9860, 9861, 9862, 9863, 9864, 9865, 9866, 9867, 9868, 9869, 9870, 9871, 9872, 9873, 9874, 9875, 9876, 9877, 9878, 9879, 9880, 9881, 9882, 9883, 9884, 9885, 9886, 9887, 9888, 9889, 9890, 9891, 9892, 9893, 9894, 9895, 9896, 9897, 9898, 9899, 9900, 9901, 9902, 9903, 9904, 9905, 9906, 9907, 9908, 9909, 9910, 9911, 9912, 9913, 9914, 9915, 9916, 9917, 9918, 9919, 9920, 9921, 9922, 9923, 9924, 9925, 9926, 9927, 9928, 9929, 9930, 9931, 9932, 9933, 9934, 9935, 9936, 9937, 9938, 9939, 9940, 9941, 9942, 9943, 9944, 9945, 9946, 9947, 9948, 9949, 9950, 9951, 9952, 9953, 9954, 9955, 9956, 9957, 9958, 9959, 9960, 9961, 9962, 9963, 9964, 9965, 9966, 9967, 9968, 9969, 9970, 9971, 9972, 9973, 9974, 9975, 9976, 9977, 9978, 9979, 9980, 9981, 9982, 9983, 9984, 9985, 9986, 9987, 9988, 9989, 9990, 9991, 9992, 9993, 9994, 9995, 9996, 9997, 9998, 9999, 10000

C/MOS

Table of C/MOS chips: 4001, 4002, 4003, 4004, 4005, 4006, 4007, 4008, 4009, 4010, 4011, 4012, 4013, 4014, 4015, 4016, 4017, 4018, 4019, 4020, 4021, 4022, 4023, 4024, 4025, 4026, 4027, 4028, 4029, 4030, 4031, 4032, 4033, 4034, 4035, 4036, 4037, 4038, 4039, 4040, 4041, 4042, 4043, 4044, 4045, 4046, 4047, 4048, 4049, 4050, 4051, 4052, 4053, 4054, 4055, 4056, 4057, 4058, 4059, 4060, 4061, 4062, 4063, 4064, 4065, 4066, 4067, 4068, 4069, 4070, 4071, 4072, 4073, 4074, 4075, 4076, 4077, 4078, 4079, 4080, 4081, 4082, 4083, 4084, 4085, 4086, 4087, 4088, 4089, 4090, 4091, 409



# SURPLUS ELECTRONICS CORP.

7294 N.W. 54th Street  
Miami, Florida 33166

WHOLESALE/RETAIL

EQUIPMENT/COMPONENTS/WIRE & CABLE/ACCESSORIES

Phone: (305) 887-8228

TWX: 810-848-6085

We accept MasterCard and Visa.

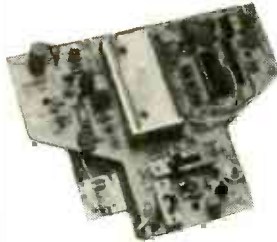

### "TANK BATTLE" TV GAME

In just a short time and with a few minor parts, the most novice hobbyist can complete this exciting Tank Battle game. Create a fun-filled evening for the whole family. Two independent tanks rumble thru land mine fields, shoot shells and fragment when hit. Four distinct engine sounds are produced for the different speeds. Sounds of gunfire, shell bursts and tank explosions are realistic. Automatic on-screen scoring. Supplied with schematic drawing.

SOLD AS IS  
**\$9.95 ea.**



### C.B. SPECIAL

CONVERT THESE TO 10 METER FM

New HY-GAIN printed circuit board assembly with PLL02A chip and 3 crystals. (Squelch pot, volume control and channel switch not included.) Boards sold as is, the way we bought them from the manufacturer. Board dimensions 6" x 6 1/2"

1-9 **\$7.50**  
10-49 **\$6.50**

50-99 **\$6.00**  
100-UP **\$5.50**

### COPPER CLAD BOARD (Double Side)

Size 9.25 x 10.75  
Thickness .062

**\$2.00 ea.**

### DIP SWITCH

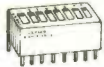

5 POSITION **\$1.00 ea.**  
8 POSITION **\$1.50 ea.**  
10 POSITION **\$2.00 ea.**  
12 POSITION **\$2.50 ea.**

### AMP METERS



2 1/4" square, no shunt required.  
Easy-to-read dial.

Movements: 0-6, 0-10, 0-17

**\$2.50 ea.**

### SPEAKER

3" Diam.,  
8 Ohm,  
5 Watts.



**\$2.00 ea.**

### COAX CONNECTORS

UG-273/U BNC-F/UHF-M **\$2.50**  
UG-255/U BNC-M/UHF-F **\$3.00**  
UG-146 A/U N-M/UHF-F **\$4.50**  
UG-83B/U N-F/UHF-M **\$4.50**  
UG-175 RG-58 Adapt **\$.20**  
UG-176 RG-59 Adapt **\$.20**  
UG-1094 BNC-F/Panel **\$1.00**  
S0239 **50c**  
PL259 **60c**

### COAXIAL CABLE

50 OHM-RG 174

**\$4.95/100' \$3.00/50'**

### SCREW DRIVER KIT



Handle stores four blades  
2 single slot 5/32" & 3/32"  
1 Phillips 1 scratch awl  
6" long with one blade inserted  
**\$1.00 ea.**

### TRIMMER CAP



1.5-20pF  
(ARCO PC-402)

**50c ea.**

### SUB-MINI 10K POT

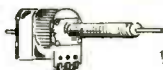

**5/\$1.00**

with On-Off  
1/4" hole mount,  
1/8" D shaft,  
3/4" thread section.

### POWER TRANSFORMER

**\$14.95 ea.**

Primary - 115 vac  
Secondary - 32 v with  
24 v tap at 15 amps  
Dim. 4 1/2" h X 3 3/4" w X 4" deep



### SOLID GEL BATTERY

6 volt @ 8 a.h. with Charger



**\$14.95**

Epipower EP 680 may be charged constant voltage or constant current. Battery is self-contained and requires no maintenance. Connections made with quick connect lugs. All plastic case size 5 1/2" h x 2 3/4" w x 4 1/2" l, weight 4 lbs.

### TEXAS INSTRUMENT KEYBOARD

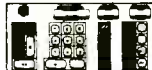

Has 3 slide switches, 26 different keys, key pad removable by 4 screws

**\$1.95 ea. 5/\$8.00**

### C & K SWITCHES



Part # Movement

J-60 7101 SPDT

L-3 7108 SPDT (momentary)

J-3 7201 DPDT (special large rocker)

**\$1.00 ea. 6/\$5.00**

### E. F. JOHNSON "S" METER



Edge Meter 250 UA, fits in 3/8" x 1 3/8" hole. Black background. Scale 1-20 Top, 0-5 Bottom.

**\$1.25 ea. 5/\$5.00**

### COMPUTER GRADE ELECTROLYTICS

| VALUE/MFD | VOLTS  | DIAM./LGTH.     | PRICE             |
|-----------|--------|-----------------|-------------------|
| 63,000    | @ 15V  | 3" x 5 1/2"     | <b>\$4.00 ea.</b> |
| 10,000    | @ 20V  | 1 1/2" x 5 3/4" | <b>\$3.00 ea.</b> |
| 2,700     | @ 25V  | 1 1/4" x 2 1/4" | <b>\$2.00 ea.</b> |
| 2,900     | @ 25V  | 1 1/4" x 2"     | <b>\$2.00 ea.</b> |
| 100,000   | @ 30V  | 3" x 5 1/2"     | <b>\$6.00 ea.</b> |
| 39,000    | @ 30V  | 1" x 5 3/4"     | <b>\$4.00 ea.</b> |
| 34,800    | @ 50V  | 3" x 5 1/2"     | <b>\$3.00 ea.</b> |
| 450       | @ 75V  | 1 1/4" x 2 1/4" | <b>\$2.00 ea.</b> |
| 500       | @ 100V | 1 1/2" x 3 1/4" | <b>\$2.00 ea.</b> |
| 50        | @ 450V | 1 1/4" x 2"     | <b>\$2.00 ea.</b> |

### TELEPHONE & TTY INTERFACE MODEM

MFG by Anderson Jacobson  
DAA Modem Model DC 230 with A-36 Telephone Coupler



**\$69.95**

Rated 300 Baud, half or full duplex. DAA level adjustable 0 to -3, -4 to -5, -7 to -10, TTY and DAA outputs brought out to 15 pin Molex connectors. FSK oscillator sends 1070 Hz space and 1270 Hz mark. Receives 2025 Hz space and 2225 Hz mark. Telephone coupler has 4-ft. cord and plug. Size 4 1/4" W x 15 L x 3" Dp. designed to be recessed in desk or panel. Electronics in case, 6 3/4" W x 12 x 2 3/4" Dp. with 8-ft. 3-wire U-ground cord and plug. Operates on 115 vac, 50/60 Hz, 1/2 Amp. Supplied with connection sheet. Removed from equipment, excellent condition, guaranteed.

### AXIAL LEAD ELECTROLYTIC CAPACITORS

2 uF @ 15V **\$12.00**  
10 uF @ 15V **\$1.00**  
20 uF @ 15V **\$1.00**  
50 uF @ 15V **\$1.00**  
2.2 uF @ 25V **\$1.00**  
3.3 uF @ 25V **\$1.00**  
1 uF @ 35V **\$1.00**  
2 uF @ 150V **\$1.00**  
25 uF @ 25V **\$2.00**  
3 uF @ 50V **\$2.00**  
5 uF @ 50V **\$2.00**  
10 uF @ 50V **\$2.00**  
250 uF @ 25V **\$2.00**  
50 uF @ 75V **\$2.00**

### MODEM CABLE ASSEMBLIES

**\$5.50 ea.**



| Conn & Hood | 22 AWG # Cond | Length |
|-------------|---------------|--------|
| 25 P        | 14            | 15'    |
| 25 S        | 10            | 17'    |

### 9 VOLT NiCd RECHARGEABLE BATTERY

NEW. Replaces the popular 9V Transistor Battery.

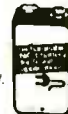

**\$4.75 ea.**

### MAHOGANY PROJECT BOX

**\$1.50 ea.**



4 3/8" w x 7 3/8" l x 3/4" to 1 1/2" h

Has a lip for recessed face plate and a felt bottom

### POWER SUPPLY

+ 12 vdc .1 amps  
+ 5 vdc .4 amps



**\$3.95 ea.**

### IC SOCKETS GOLD-PLATED WIRE WRAP

14 pin **40c ea.**

16 pin **45c ea.**



### MUFFIN FANS



MFG By Rotron Inc.  
3 Blades 4 1/4" Square  
USED

110 VAC **\$5.95 ea.**

NEW

230 VAC Model MU3A1

**\$12.00 ea.**

### NEW SPRITE FAN

Mfg. by Rotron Inc.,  
Model SU2A5,  
115v AC, .19 amps.  
(Impedance protected.)  
3 1/4" x 3 1/4" x 1 1/4"

**\$12.00 ea.**

### 7' POWER CORD HEWLETT PACKARD TYPE



Molded 3 Prong Plug with molded receptacle  
Belden 16 AWG

**\$3.00 ea.**

### 24-Volt POWER SUPPLY 5.4 AMPS

MFG by ACDC Electronics Inc.  
Model OEM 24N5-4-1



Input 105-125 vac 50/60 Hz. Has volt adj and O.L. adj. Output terminals contain +, out, - sen.

- sen, - out, ac neut, ac line and GND. 13 LBS.

**\$45.00**

**TERMS:** All material guaranteed unless otherwise stated. If you are not satisfied with our product, it may be returned within 10 days for a refund (less shipping). Please add \$4.00 for shipping and handling on all orders. COD's accepted for orders totaling \$50 or more. All orders shipped UPS unless otherwise specified. Florida residents please add 4% sales tax. Minimum order, \$15.00. Foreign orders - US funds only, add 20% for shipping and handling.

# 16K Memory

4116-200ns **8/15.95**

ALL MERCHANDISE 100% GUARANTEED!

CALL US FOR VOLUME QUOTES

## EPROMS

|         |          |                      | Each  | 8 pcs |
|---------|----------|----------------------|-------|-------|
| 1702    | 256 x 8  | (1ns)                | 4.95  | 4.50  |
| 2708    | 1024 x 8 | (450ns)              | 2.99  | 2.75  |
| 2758    | 1024 x 8 | (5V) (450ns)         | 9.95  | 8.95  |
| TMS2516 | 2048 x 8 | (5V) (450ns)         | 6.95  | 5.95  |
| 2716    | 2048 x 8 | (5V) (450ns)         | 5.50  | 4.95  |
| 2716-1  | 2048 x 8 | (5V) (350ns)         | 9.00  | 8.50  |
| TMS2716 | 2048 x 8 | (450ns)              | 9.95  | 8.95  |
| TMS2532 | 4096 x 8 | (5V) (450ns)         | 12.95 | 11.95 |
| 2732    | 4096 x 8 | (5V) (450ns) (200ns) |       | CALL  |
| 2764    | 8192 x 8 | (5V) (450ns)         |       | CALL  |

## DYNAMIC RAMS

|          |            |         | 100 pcs |      |
|----------|------------|---------|---------|------|
| 4027     | 4096 x 1   | (250ns) | 2.50    | 2.00 |
| 4116-120 | 16,384 x 1 | (120ns) | 8/29.95 | CALL |
| 4116-150 | 16,384 x 1 | (150ns) | 8/18.95 | 1.95 |
| 4116-200 | 16,384 x 1 | (200ns) | 8/15.95 | 1.80 |
| 4116-300 | 16,384 x 1 | (300ns) | 8/14.95 | 1.75 |
| 4164     | 64,536 x 1 | (200ns) |         | CALL |

## STATIC RAMS

|            |          |                         | 100 pcs |      |
|------------|----------|-------------------------|---------|------|
| 2101       | 256 x 4  | (450ns)                 | 1.95    | 1.85 |
| 2102-1     | 1024 x 1 | (450ns)                 | .89     | .85  |
| 21L02-4    | 1024 x 1 | (L-) (450ns)            | 1.29    | 1.15 |
| 21L02-2    | 1024 x 1 | (LP) (250ns)            | 1.69    | 1.55 |
| 2111       | 256 x 4  | (450ns)                 | 2.99    | 2.49 |
| 2112       | 256 x 4  | (450ns)                 | 2.99    | 2.79 |
| 2114       | 1024 x 4 | (450ns)                 | 8/16.95 | 1.95 |
| 2114L-2    | 1024 x 4 | (L-) (200ns)            | 8/19.95 | 2.35 |
| 2114L-3    | 1024 x 4 | (L-) (300ns)            | 8/18.95 | 2.25 |
| 2114L-4    | 1024 x 4 | (L-) (450ns)            | 8/17.95 | 2.10 |
| 2147       | 4096 x 1 | (5ns)                   | 9.95    | CALL |
| TMS4044-4  | 4096 x 1 | (450ns)                 | 3.49    | 3.25 |
| TMS4044-3  | 4096 x 1 | (300ns)                 | 3.99    | 3.75 |
| TMS40L44-2 | 4096 x 1 | (LP) (200ns)            | 4.49    | 4.25 |
| TMM2016    | 2048 x 8 | (200ns) (150ns)         |         | CALL |
| HM6116     | 2048 x 8 | (200ns) (150ns) (120ns) |         | CALL |

LP = LOW POWER

## CRYSTALS

|            |      |
|------------|------|
| 32.768 KHZ | 3.95 |
| 1.0 MHZ    | 4.95 |
| 1.8432     | 4.95 |
| 2.0        | 3.95 |
| 2.097152   | 3.95 |
| 2.4576     | 3.95 |
| 3.2768     | 3.95 |
| 3.579545   | 3.95 |
| 4.0        | 3.95 |
| 5.0        | 3.95 |
| 5.0688     | 3.95 |
| 5.185      | 3.95 |
| 5.7143     | 3.95 |
| 6.5536     | 3.95 |
| 8.0        | 3.95 |
| 10.0       | 3.95 |
| 14.31818   | 3.95 |
| 18.0       | 3.95 |
| 18.432     | 3.95 |
| 20.0       | 3.95 |
| 22.1184    | 3.95 |
| 32.0       | 3.95 |

## MISC.

|          |       |
|----------|-------|
| AY5-2376 | 12.50 |
| 11C90    | 13.95 |
| XR2206   | 4.95  |
| 3242     | 7.95  |
| 3480     | 9.00  |
| MC4024   | 3.95  |
| MC4044   | 4.50  |
| 7103     | 9.50  |
| 7106     | 9.95  |
| 7107     | 12.95 |
| 76477    | 3.95  |
| 8038     | 3.95  |
| 95H90    | 7.99  |
| 9602     | 1.50  |

## DISC CONTROLLERS

|      |       |
|------|-------|
| 1771 | 24.95 |
| 1791 | 36.95 |
| 1793 | 44.95 |
| 1797 | 54.95 |

## UARTS

|          |      |
|----------|------|
| AY3-1014 | 6.95 |
| AY5-1013 | 3.95 |
| TR1602   | 4.95 |
| IM6402   | 7.95 |

## INTERFACE

|        |      |
|--------|------|
| 8T26   | 1.69 |
| 8T28   | 2.49 |
| 8T95   | .99  |
| 8T96   | .99  |
| 8T97   | .99  |
| 8T98   | .99  |
| DM8131 | 2.95 |
| DS8836 | 1.29 |

## CLOCK CIRCUITS

|         |       |
|---------|-------|
| MM5369  | 3.95  |
| MM5375  | 3.95  |
| MSM5832 | 7.45  |
| 7207    | 7.50  |
| 7208    | 15.95 |

## CONVERTERS

|           |      |
|-----------|------|
| MC1408 L8 | 4.95 |
| DAC-0800  | 4.95 |
| ADC-0804  | 4.95 |

## March Specials

|           |      |
|-----------|------|
| Z-80A-CPU | 6.00 |
| Z-80A-PIO | 6.00 |
| 8214      | 2.95 |
| 8216      | 1.50 |
| 6800      | 4.95 |
| 6810      | 3.95 |

## TMS 40L44-20 4096 x 1 low power 200ns RAMS

By Texas Instruments - not equivalent part number made by another manufacturer as sold by others:

4.49 each 125.00/32 pcs.

Specials end March 28, 1982  
Please state "March Specials" when ordering

**800-538-5000**  
**800-662-6279**  
(CALIFORNIA RESIDENTS)

CALL JDR BEFORE YOU BUY!  
WE WILL BEAT ANY COMPETITORS' PRICES

## 6502

|        |       |
|--------|-------|
| 6502   | 6.95  |
| 6502-A | 12.95 |
| 6504   | 6.95  |
| 6505   | 8.95  |
| 6507   | 9.95  |
| 6520   | 4.35  |
| 6522   | 9.95  |
| 6532   | 14.95 |
| 6551   | 11.85 |

## Z80

|            |       |
|------------|-------|
| Z80-CPU    | 8.95  |
| Z80A-CPU   | 6.00  |
| Z80-PIO    | 6.50  |
| Z80A-PIO   | 6.00  |
| Z80-CTC    | 5.95  |
| Z80A-CTC   | 8.65  |
| Z80-DART   | 15.25 |
| Z80A-DART  | 18.75 |
| Z80-DMA    | 17.50 |
| Z80A-DMA   | 27.50 |
| Z80-S10/0  | 23.95 |
| Z80A-S10/0 | 28.95 |
| Z80-S10/1  | 23.95 |
| Z80A-S10/1 | 28.95 |
| Z80-S10/2  | 23.95 |
| Z80A-S10/2 | 28.95 |
| Z80-S10/9  | 17.95 |
| Z80A-S10/9 | 22.95 |
| Z80B-CPU   | 18.95 |
| Z80B-CTC   | 17.95 |
| Z80B-PIO   | 17.95 |
| Z8671      | 39.95 |
| Z6132      | 34.95 |

## 74LS00 SERIES

|        |      |         |      |         |      |         |      |
|--------|------|---------|------|---------|------|---------|------|
| 74LS00 | .25  | 74LS85  | 1.15 | 74LS166 | 2.40 | 74LS293 | 1.85 |
| 74LS01 | .25  | 74LS86  | .40  | 74LS168 | 1.75 | 74LS295 | 1.05 |
| 74LS02 | .25  | 74LS90  | .65  | 74LS169 | 1.75 | 74LS298 | 1.20 |
| 74LS03 | .25  | 74LS91  | .89  | 74LS170 | 1.75 | 74LS324 | 1.75 |
| 74LS04 | .25  | 74LS92  | .70  | 74LS173 | .80  | 74LS352 | 1.55 |
| 74LS05 | .25  | 74LS93  | .65  | 74LS174 | .95  | 74LS353 | 1.55 |
| 74LS08 | .35  | 74LS94  | .65  | 74LS175 | .95  | 74LS363 | 1.35 |
| 74LS10 | .25  | 74LS95  | .85  | 74LS181 | 2.15 | 74LS364 | 1.95 |
| 74LS11 | .35  | 74LS96  | .95  | 74LS189 | 9.95 | 74LS365 | .95  |
| 74LS12 | .35  | 74LS97  | .40  | 74LS190 | 1.00 | 74LS366 | .95  |
| 74LS13 | .45  | 74LS109 | .40  | 74LS191 | 1.00 | 74LS367 | .70  |
| 74LS14 | 1.00 | 74LS112 | .45  | 74LS192 | .85  | 74LS368 | .70  |
| 74LS15 | .35  | 74LS113 | .45  | 74LS193 | .95  | 74LS373 | .99  |
| 74LS20 | .25  | 74LS114 | .50  | 74LS194 | 1.00 | 74LS374 | 1.75 |
| 74LS21 | .35  | 74LS122 | .45  | 74LS195 | .95  | 74LS377 | 1.45 |
| 74LS22 | .25  | 74LS123 | .95  | 74LS196 | .85  | 74LS378 | 1.18 |
| 74LS26 | .35  | 74LS124 | 2.99 | 74LS197 | .85  | 74LS379 | 1.35 |
| 74LS27 | .35  | 74LS125 | .95  | 74LS221 | 1.20 | 74LS385 | 1.90 |
| 74LS28 | .35  | 74LS126 | .85  | 74LS240 | .99  | 74LS386 | .65  |
| 74LS30 | .25  | 74LS136 | .55  | 74LS241 | .99  | 74LS390 | 1.90 |
| 74LS32 | .35  | 74LS137 | .99  | 74LS242 | 1.85 | 74LS393 | 1.90 |
| 74LS33 | .55  | 74LS138 | .75  | 74LS243 | 1.85 | 74LS395 | 1.65 |
| 74LS37 | .55  | 74LS139 | .75  | 74LS244 | .99  | 74LS399 | 1.70 |
| 74LS38 | .35  | 74LS145 | 1.20 | 74LS245 | 1.90 | 74LS424 | 2.95 |
| 74LS40 | .35  | 74LS147 | 2.49 | 74LS247 | .76  | 74LS447 | .37  |
| 74LS42 | .55  | 74LS148 | 1.35 | 74LS248 | 1.25 | 74LS490 | 1.95 |
| 74LS47 | .75  | 74LS151 | .75  | 74LS249 | .99  | 74LS668 | 1.69 |
| 74LS48 | .75  | 74LS153 | .75  | 74LS251 | 1.30 | 74LS669 | 1.89 |
| 74LS49 | .75  | 74LS154 | 2.35 | 74LS253 | .85  | 74LS670 | 2.20 |
| 74LS51 | .25  | 74LS155 | 1.15 | 74LS257 | .85  | 74LS674 | 9.65 |
| 74LS54 | .35  | 74LS156 | .95  | 74LS258 | .85  | 74LS682 | 3.20 |
| 74LS55 | .35  | 74LS157 | .75  | 74LS259 | 2.85 | 74LS683 | 2.30 |
| 74LS63 | 1.25 | 74LS158 | .75  | 74LS260 | .65  | 74LS684 | 2.40 |
| 74LS73 | .40  | 74LS159 | .90  | 74LS266 | .55  | 74LS685 | 2.40 |
| 74LS74 | .45  | 74LS161 | .95  | 74LS273 | 1.65 | 74LS688 | 2.40 |
| 74LS75 | .50  | 74LS162 | .95  | 74LS275 | 3.35 | 74LS689 | 2.40 |
| 74LS76 | .40  | 74LS163 | .95  | 74LS279 | .55  | 81LS95  | 1.69 |
| 74LS78 | .50  | 74LS164 | .95  | 74LS280 | 1.98 | 81LS96  | 1.69 |
| 74LS83 | .75  | 74LS165 | .95  | 74LS283 | 1.00 | 81LS97  | 1.69 |
|        |      |         |      | 74LS290 | 1.25 | 81LS98  | 1.69 |

HOURS: Mon. - Fri., 9 to 5; Sat., 11 to 3



## JDR MICRODEVICES, INC.

1224 So. Bascom Ave.

San Jose, CA 95128

800-538-5000 • 800-662-6279 (CA)

(408) 995-5430 • Telex 171-110

## VISIT OUR RETAIL STORE!

TERMS: For shipping include \$2.00 for UPS ground, \$3.00 for UPS Blue Label air. \$10.00 minimum order. Bay Area residents add 6 1/2% sales tax. California residents add 6% sales tax. We reserve the right to limit quantities and substitute manufacturer. Prices subject to change without notice. Send SASE for complete list.



# 2716 EPROMS 450NS (5V)

# 8/4.95 ea.

ALL MERCHANDISE 100% GUARANTEED!

CALL US FOR VOLUME QUOTES

### 8000

|         |       |
|---------|-------|
| 8035    | 16.95 |
| 8039    | 19.95 |
| 8080A   | 3.95  |
| 8085    | 12.95 |
| 8085A-2 | 16.95 |
| 8086    | 99.95 |
| 8088    | 39.95 |
| 8155    | 11.95 |
| 8156    | 11.95 |
| 8185    | 29.95 |
| 8185-2  | 39.95 |
| 8741    | 39.95 |
| 8748    | 29.95 |
| 8755    | 44.95 |

### 8200

|        |       |
|--------|-------|
| 8202   | 45.00 |
| 8205   | 3.50  |
| 8212   | 1.85  |
| 8214   | 3.85  |
| 8216   | 1.80  |
| 8224   | 2.50  |
| 8226   | 1.80  |
| 8228   | 4.90  |
| 8237   | 19.95 |
| 8238   | 4.95  |
| 8239   | 4.85  |
| 8243   | 4.45  |
| 8250   | 14.95 |
| 8251   | 4.75  |
| 8253   | 9.25  |
| 8253-5 | 9.85  |
| 8255   | 4.75  |
| 8255-5 | 5.25  |
| 8257   | 8.75  |
| 8259   | 6.90  |
| 8272   | 39.95 |
| 8275   | 29.95 |
| 8279   | 9.50  |
| 8279-5 | 10.50 |
| 8282   | 6.65  |
| 8283   | 6.65  |
| 8284   | 5.70  |
| 8286   | 6.65  |
| 8287   | 6.50  |
| 8288   | 25.00 |
| 8289   | 49.95 |

### TV CIRCUITS

|        |      |
|--------|------|
| MC1330 | 1.89 |
| MC1350 | 1.29 |
| MC1358 | 1.79 |
| LM380  | 1.29 |
| LM386  | 1.50 |
| LM565  | .99  |
| LM741  | .29  |
| LM1310 | 2.90 |
| LM1800 | 2.99 |
| LM1889 | 1.49 |



### APPLE FAN \$69.00

- EXTRA PLUG-IN CARDS CAN CAUSE YOUR APPLE TO OVERHEAT
- ULTRA-QUIET APPLE FAN DRAWS COOL AIR THROUGH YOUR COMPUTER
- ELIMINATES DOWN TIME
- SAVES REPAIR CHARGES
- INCREASES RELIABILITY
- CLIPS ON — NO HOLES OR SCREWS
- COLOR MATCHES APPLE
- LONG LIFE, LOW NOISE MOTOR



\* APPLE IS A TRADEMARK OF APPLE COMPUTER INC.

### IC SOCKETS

|                 |           |
|-----------------|-----------|
| 1-99            | 100       |
| 8 pin ST        | .13 .11   |
| 14 pin ST       | .15 .12   |
| 16 pin ST       | .17 .13   |
| 16 pin ST       | .20 .18   |
| 20 pin ST       | .29 .27   |
| 22 pin ST       | .30 .27   |
| 24 pin ST       | .30 .27   |
| 26 pin ST       | .40 .32   |
| 40 pin ST       | .49 .39   |
| ST = SOLDERTAIL |           |
| 8 pin WW        | .59 .49   |
| 14 pin WW       | .69 .52   |
| 16 pin WW       | .69 .58   |
| 18 pin WW       | .99 .90   |
| 20 pin WW       | 1.09 .98  |
| 22 pin WW       | 1.39 1.28 |
| 24 pin WW       | 1.49 1.35 |
| 23 pin WW       | 1.69 1.49 |
| 40 pin WW       | 1.99 1.80 |
| WW = WIREWRAP   |           |

### CONNECTORS

|              |      |
|--------------|------|
| FS232 MALE   | 3.25 |
| FS232 FEMALE | 3.75 |
| FS232 HOOD   | 1.25 |
| S-100 ST     | 3.95 |
| S-100 WW     | 4.95 |

### DIP SWITCHES

|            |     |
|------------|-----|
| 4 POSITION | .85 |
| 5 POSITION | .90 |
| 6 POSITION | .90 |
| 7 POSITION | .95 |
| 6 POSITION | .95 |

### 6800

|       |       |
|-------|-------|
| 6800  | 5.70  |
| 6802  | 10.95 |
| 6808  | 9.95  |
| 6809  | 24.95 |
| 6809E | 29.95 |
| 6810  | 4.60  |
| 6820  | 4.95  |
| 6821  | 4.95  |
| 6828  | 9.95  |
| 6834  | 16.95 |
| 6840  | 14.95 |
| 6843  | 42.95 |
| 6844  | 44.95 |
| 6845  | 16.95 |
| 6847  | 15.95 |
| 6850  | 4.75  |
| 6852  | 5.75  |
| 6860  | 10.95 |
| 6862  | 11.95 |
| 6875  | 6.95  |
| 6880  | 2.95  |
| 68B00 | 10.95 |
| 68B21 | 12.95 |
| 68B50 | 12.95 |

### EPROM ERASERS

|                     |        |
|---------------------|--------|
| PE-14               | 78.50  |
| PE-14T (with timer) | 108.50 |
| PE-24T (with timer) | 154.50 |

ALL ARE HIGH QUALITY UNITS ENCLOSED IN A BLACK ANODIZED ALUMINUM ENCLOSURE.

OUR AD MAY BE IMITATED BUT OUR SERVICE CAN NEVER BE DUPLICATED.

### TRANSISTORS

|                |         |           |
|----------------|---------|-----------|
| PN2222         | 10/1.00 | 100/ 8.99 |
| 2N2222         | .25     | 50/10.99  |
| 2N2907         | .25     | 50/10.99  |
| 2N3055         | .79     | 10/ 6.99  |
| 2N3904         | 10/1.00 | 100/ 8.99 |
| 2N3906         | 10/1.00 | 100/ 8.99 |
| 1N4148 (1N914) |         | 10/ 1.00  |
| 1N4004         |         | 25/ 1.00  |

### VOLTAGE REG's

|        |      |        |      |
|--------|------|--------|------|
| 7805T  | .79  | 7905T  | .89  |
| 7808T  | .99  | 7912T  | .89  |
| 7812T  | .79  | 7915T  | 1.19 |
| 7815T  | .99  | 7924T  | 1.19 |
| 7824T  | .99  |        |      |
| 7805K  | 1.39 | 7905K  | 1.49 |
| 7812K  | 1.39 | 7912K  | 1.49 |
| 7815K  | 1.39 | 79LO5  | .79  |
| 78LO5  | .69  | 79L12  | .79  |
| 78L12  | .69  | 79L15  | .79  |
| 78L15  | .69  |        |      |
| LM309K | 1.49 | LM317K | 3.95 |
| LM317T | 1.95 | LM323K | 4.95 |
|        |      | LM337K | 3.95 |

T = TO-220 K = TO-3 L = TO-92

### LINEAR

|         |      |
|---------|------|
| LM301V  | .34  |
| LM308V  | .98  |
| LM309K  | 1.49 |
| LM311   | .54  |
| LM317T  | 1.95 |
| LM317K  | 3.35 |
| LM318   | 1.49 |
| LM323K  | 4.35 |
| LM324   | .59  |
| LM337K  | 3.95 |
| LM339   | .99  |
| LM377   | 2.29 |
| LM380   | 1.29 |
| LM386V  | 1.50 |
| LM555V  | .39  |
| LM556   | .69  |
| LM565   | .99  |
| LM566V  | 1.49 |
| LM567V  | 1.29 |
| LM723   | .49  |
| LM733   | .98  |
| LM741V  | .29  |
| LM747   | .79  |
| LM748V  | .59  |
| LM1310  | 2.90 |
| MC1330V | 1.89 |
| MC1350V | 1.29 |
| MC1358  | 1.79 |
| LM1414  | 1.59 |
| LM1458V | .69  |
| LM1488  | .99  |
| LM1489  | .99  |
| LM1800  | 2.99 |
| LM1889  | 2.49 |
| LM3900  | .59  |
| LM3909V | .98  |
| LM3914  | 3.95 |
| LM3915  | 3.95 |
| LM3916  | 3.95 |
| 75451V  | .39  |
| 75452V  | .39  |
| 75453V  | .39  |

### 7400 SERIES

|      |     |       |      |       |      |       |       |
|------|-----|-------|------|-------|------|-------|-------|
| 7400 | .19 | 7451  | .23  | 74136 | .50  | 74186 | 18.50 |
| 7401 | .19 | 7453  | .23  | 74141 | .65  | 74190 | 1.15  |
| 7402 | .19 | 7454  | .23  | 74142 | 2.95 | 74191 | 1.15  |
| 7403 | .19 | 7460  | .23  | 74143 | 2.95 | 74192 | .79   |
| 7404 | .19 | 7470  | .35  | 74144 | 2.95 | 74193 | .79   |
| 7405 | .22 | 7472  | .29  | 74145 | .60  | 74194 | .85   |
| 7406 | .22 | 7473  | .34  | 74147 | 1.75 | 74195 | .85   |
| 7407 | .22 | 7474  | .35  | 74148 | 1.20 | 74196 | .79   |
| 7408 | .24 | 7475  | .49  | 74150 | 1.35 | 74197 | .75   |
| 7409 | .19 | 7476  | .35  | 74151 | .65  | 74198 | 1.35  |
| 7410 | .19 | 7480  | .59  | 74152 | .65  | 74199 | 1.35  |
| 7411 | .25 | 7481  | 1.10 | 74153 | .55  | 74221 | 1.35  |
| 7412 | .30 | 7482  | .95  | 74154 | 1.40 | 74246 | 1.35  |
| 7413 | .35 | 7483  | .50  | 74155 | .75  | 74247 | 1.25  |
| 7414 | .55 | 7485  | .65  | 74156 | .65  | 74248 | 1.85  |
| 7415 | .25 | 7486  | .35  | 74157 | .55  | 74249 | 1.95  |
| 7416 | .25 | 7489  | 4.95 | 74159 | 1.65 | 74251 | .75   |
| 7417 | .19 | 7490  | .35  | 74160 | .85  | 74259 | 2.25  |
| 7418 | .35 | 7491  | .40  | 74161 | .70  | 74265 | 1.35  |
| 7419 | .29 | 7492  | .50  | 74162 | .85  | 74273 | 1.95  |
| 7420 | .29 | 7493  | .49  | 74163 | .85  | 74276 | 1.25  |
| 7421 | .29 | 7494  | .65  | 74164 | .85  | 74279 | .75   |
| 7422 | .29 | 7495  | .55  | 74165 | .85  | 74283 | 2.00  |
| 7423 | .29 | 7496  | .70  | 74166 | 1.00 | 74284 | 3.75  |
| 7424 | .45 | 7497  | 2.75 | 74167 | 2.95 | 74285 | 3.75  |
| 7425 | .19 | 74100 | 1.00 | 74170 | 1.65 | 74290 | .95   |
| 7426 | .29 | 74107 | .30  | 74172 | 5.95 | 74293 | .75   |
| 7427 | .29 | 74109 | .45  | 74173 | .75  | 74298 | .85   |
| 7428 | .29 | 74110 | .45  | 74174 | .89  | 74351 | 2.25  |
| 7429 | .19 | 74111 | .55  | 74175 | .89  | 74365 | .65   |
| 7430 | .19 | 74116 | 1.55 | 74176 | .89  | 74366 | .65   |
| 7431 | .49 | 74120 | 1.20 | 74177 | .75  | 74367 | .65   |
| 7432 | .65 | 74121 | .29  | 74178 | 1.15 | 74368 | .65   |
| 7433 | .69 | 74122 | .45  | 74179 | 1.75 | 74376 | 2.20  |
| 7434 | .69 | 74123 | .55  | 74180 | .75  | 74390 | 1.75  |
| 7435 | .59 | 74125 | .45  | 74181 | 2.25 | 74393 | 1.35  |
| 7436 | .69 | 74126 | .45  | 74182 | .75  | 74425 | 3.15  |
| 7437 | .69 | 74128 | .55  | 74184 | 2.00 | 74426 | .85   |
| 7438 | .19 | 74132 | .45  | 74185 | 2.00 | 74490 | 2.55  |

### 74S00 SERIES

|       |      |         |      |        |       |        |       |
|-------|------|---------|------|--------|-------|--------|-------|
| 74S00 | 44   | 74S74   | .69  | 74S163 | 3.75  | 74S257 | 1.39  |
| 74S02 | 48   | 74S85   | 2.39 | 74S168 | 4.65  | 74S258 | 1.49  |
| 74S03 | 48   | 74S86   | 1.44 | 74S169 | 5.44  | 74S260 | 1.83  |
| 74S04 | 79   | 74S11-2 | 1.59 | 74S174 | 1.09  | 74S274 | 19.95 |
| 74S05 | 79   | 74S11-3 | 1.98 | 74S175 | 1.09  | 74S275 | 19.95 |
| 74S08 | 48   | 74S11-4 | 1.50 | 74S181 | 4.47  | 74S280 | 2.90  |
| 74S09 | 98   | 74S124  | 2.77 | 74S182 | 2.95  | 74S287 | 4.75  |
| 74S10 | 69   | 74S132  | 1.24 | 74S188 | 3.95  | 74S288 | 4.45  |
| 74S11 | 88   | 74S133  | .98  | 74S189 | 14.95 | 74S289 | 6.98  |
| 74S15 | 70   | 74S134  | .69  | 74S194 | 2.95  | 74S301 | 6.95  |
| 74S20 | 68   | 74S135  | 1.48 | 74S195 | 1.89  | 74S373 | 3.45  |
| 74S22 | 98   | 74S138  | 1.08 | 74S196 | 4.90  | 74S374 | 3.45  |
| 74S30 | 48   | 74S139  | 1.25 | 74S197 | 4.25  | 74S381 | 7.95  |
| 74S32 | 98   | 74S140  | 1.45 | 74S201 | 14.95 | 74S387 | 5.75  |
| 74S37 | 1.87 | 74S151  | 1.19 | 74S225 | 8.95  | 74S412 | 2.98  |
| 74S38 | 1.68 | 74S153  | 1.19 | 74S240 | 3.98  | 74S471 | 9.95  |
| 74S40 | 44   | 74S157  | 1.19 | 74S241 | 3.75  | 74S472 | 16.85 |
| 74S51 | .78  | 74S158  | 1.45 | 74S244 | 3.98  | 74S474 | 17.85 |
| 74S64 | .79  | 74S151  | 2.85 | 74S251 | 1.90  | 74S482 | 15.60 |
| 74S65 | 1.25 | 74S152  | 3.70 | 74S253 | 7.45  | 74S570 | 7.80  |
|       |      |         |      |        |       | 74S571 | 7.80  |

HOURS: Mon. - Fri., 9 to 5; Sat. 11 to 3

VISIT OUR RETAIL STORE!



### JDR MICRODEVICES, INC.

1224 S. Bascom Ave.  
San Jose, CA 95128

800-538-50C0 • 800-662-6279 (CA)  
(408) 995-5430 • Telex 171-110

TERMS: For shipping include \$2.00 for UPS Ground, \$3.00 for UPS Blue Label Air. \$10.00 minimum order. Bay Area residents add 6 1/2 % sales tax. California residents add 6% sales tax. We reserve the right to limit quantities and substitute manufacturer. Prices subject to change without notice. Send SASE for complete list.

|   |  |  |   |  |  |
|---|--|--|---|--|--|
| <b>\$395</b><br><br><b>SONALERT</b><br>MALLORY SNP-428<br>4-28 VDC 3-16 ma.<br>Fits 1 1/8" hole         | <b>\$795</b><br><br><b>SOLDER</b><br>KESTER 60/40<br>Rosin core .020 dia.<br>1-Pound Roll  | <b>\$1200</b><br><br><b>FAN</b><br>Whisper by Rotron<br>WR2H1 4-3/4" Sq.<br>115 VAC 7 Watt         | <b>5 VOLT STEPPING MOTOR \$2000</b><br><br>SLO-SYN MP70-1A-Z9-1A-005<br>5.2 V @ 1.44 A 48 Steps/Rev.<br>1/4" Shaft 1/2" L. Mtg. Holes 2-3/16" C-C | <b>SHUGART HEAD</b><br><br>Fits SHUGART 800/801<br><b>\$6500</b>   | <br><b>DYNAMIC RAMS</b><br>4K x 1 300 ns<br>D2104A 16 Pin<br>TMS 4030 22 Pin<br><b>95c</b><br><b>PROM</b><br>Harris 7640<br>512 x 8 VOL OC<br>24 Pin \$795<br><b>UART</b><br>COM 2502 25KHz<br>40 Pin +5 -12<br><b>\$495</b> |
| <br><b>JOYSTICK</b><br>4 - 10K Linear pots<br>1 - 1/2" metal handle<br>2 - 1/8" square<br><b>\$595</b> | <br><b>POWER SUPPLY</b><br><b>\$4750</b><br>IN PUT<br>110 - 220 VAC<br>5 - 3/4 x 7 - 1/2 x 4" h<br>OUTPUT<br>+ 5 VDC - 5 Amp.<br>+ 12 VDC - 1 Amp.<br>- 12 VDC - 1 Amp. | <b>DIABLO PRINT HEAD</b><br><br>Matrix Head #24800<br>Fits DIABLO 1660<br><b>\$9500</b>           | <b>BRIDGE 10 AMP 600 VOLT 200 ns Tr</b><br><br>VARO VJ648X<br>1/2" Leads<br><b>\$200 10 for \$1500</b>  | <b>1000 VOLT 12 AMP DIODE</b><br><br>MR 1130 R<br><b>\$125 10 for \$1000</b>  | <b>COMPUTER GRADE CAPS</b><br>5,200 MFD 25VDC<br>1-7/16 x 2-3/8H <b>\$125</b><br>11,000 MFD 35VDC<br>1-3/4 x 4-1/2 h <b>\$350</b><br>12,000 MFD 25VDC<br>1-7/16 x 3-7/16 h <b>\$250</b><br>22,000 MFD 25VDC<br>1-7/16 x 41/4 h <b>\$350</b>  |
| <br><b>EDGE METER</b><br>0 - 15 VDC<br>25/32 x 1-13/16<br><b>\$350</b>                                 | <b>SHIELDED POWER CORD</b><br><br>6' - 7" Lg. <b>\$250 10 for \$2000</b>  | <b>RS-232 CONNECTOR</b><br><br>DBC-25P male<br>Crimp Pin <b>\$225</b><br>DB-25 cover <b>\$125</b> | <b>LM 323 5 VOLT 3 AMP</b><br><br><b>\$395</b><br>Heat Sink 75c  | <b>DATA CASSETTES</b><br><br><b>\$175</b><br>10 for \$1500<br>Made for Datapoint<br>by Maxell<br>60 min. with case<br>5 screw high strength shell | <b>TRIAC</b><br><br><b>MAC 10-4</b><br>10 AMP <b>\$125</b><br>200 V 10 for \$1000   |
| <b>ROTARY DIP SWITCH</b><br><br>10 Position BCD<br><b>\$150 10 for \$1250</b>                          | <b>REFLECTIVE SENSOR</b><br><br>MONSANTO MCA 7<br>Infrared emitter and<br>Photo Darlington output<br><b>\$150 10 for \$1250</b>   | <b>PHONE JACK</b><br><br><b>25c</b><br>Switchcraft #12A<br>1/4" 2 conductor<br>with Switch        | <b>7812 12 VOLT 1 AMP</b><br><br><b>90c 10 for \$750</b><br>Heat Sink 25c  | <b>TERMS</b><br>Quantities Limited<br>COD, check, money order<br>VISA, Mastercharge<br>Texas residents add 5% state sales tax.<br>Add 13% shipping charges for orders<br>under \$500.  |  |
| <b>ALTEX ELECTRONICS</b><br>618 W. Sunset<br>San Antonio, Texas<br>78216<br><b>1-800-531-5369</b><br>In Texas Call<br>(512) 828-0503  |  |  |   |  |  |

CIRCLE 15 ON FREE INFORMATION CARD

**CALIFORNIA COMPUTER SYSTEMS**

|                       |  |          |
|-----------------------|--|----------|
| <b>\$100</b>          | 2032 32K STATIC RAM A & T                |          |
|                       | 200 NSEC                                 | \$629.00 |
|                       | 2116 16K STATIC RAM A & T                |          |
|                       | 200 NSEC                                 | \$329.00 |
|                       | 2065 64K DYNAMIC RAM A & T               | \$548.95 |
|                       | 2200 S-100 MAIN FRAM A & T               | \$379.95 |
|                       | 2422 FLOPPY DISC WITH CP/M 2.2"          | \$329.95 |
|                       | 2802 6502 PROCESSOR A & T                | \$282.95 |
|                       | 2810A Z80 CPU A & T                      | \$249.95 |
|                       | 2710A 4 SERIAL 1/0 A & T                 | \$291.95 |
|                       | 2718A 2 SERIAL, 2 PARALLEL A & T         | \$305.95 |
|                       | 2720A 4 PARALLEL A & T                   | \$214.95 |
|                       | PROTO BOARDS WW                          | \$39.95  |
| <b>APPLE PRODUCTS</b> |  |          |
|                       | 7114A 12K ROM/PROM                       | \$68.50  |
|                       | 7424A CALENDAR/CLOCK                     | \$106.95 |
|                       | 7440A PROGRAMMABLE TIMER                 | \$98.50  |
|                       | 7470A A TO O CONVERTER                   | \$105.95 |
|                       | 7490A GPIB (IE 488) INTERFACE            | \$265.95 |
|                       | 7710A ASYNC SERIAL                       | \$125.95 |
|                       | 7712A SYNC SERIAL                        | \$153.95 |
|                       | 7720A PARALLEL STANDARD                  | \$98.95  |
|                       | 7720B PARALLEL CENTRONICS                | \$98.95  |
|                       | 7811B ARITHMETIC PROCESSOR W/DISC        | \$342.95 |
|                       | 7811C ARITHMETIC PROCESSOR W/ROM         | \$342.95 |
|                       | 7500A WW BOARD                           | \$22.95  |
|                       | 7510A SOLDEXTAIL BOARD                   | \$23.95  |
| <b>SOFTWARE</b>       |  |          |
|                       | 2610 CP/M™ MACRO ASSEMBLER ON DISK       | \$76.95  |
|                       | 2620 CP/M™ SYMBOLIC INSTRUCTION DEBUGGER | \$64.25  |
|                       | 2630 CP/M™ TEXT FORMATER                 | \$64.25  |
|                       | 2640 CP/M™ BACKGROUND PRINT UTILITY      | \$42.95  |

OTHER CCS PRODUCTS ARE AVAILABLE  
CALL FOR PRICE.

**SSM MICROCOMPUTER PRODUCTS**

|                                  |                 |          |
|----------------------------------|-----------------|----------|
| <b>\$100 PRODUCTS</b>            |                 |          |
| CB1A 8080 PROCESSOR PCBD         |                 | \$32.95  |
| KIT                              | \$155.95, A & T | \$215.95 |
| CB-2 280 PROCESSOR BOARD         |                 |          |
| KIT                              | \$198.95, A & T | \$269.95 |
| VBIC 64 x 16 VIDEO, PCBD         |                 | \$32.95  |
| KIT                              | \$153.95, A & T | \$199.95 |
| VB2 64 x 16 VIDEO, PCBD          |                 | \$32.95  |
| KIT                              | \$175.95, A & T | \$234.95 |
| VB3 80 CHARACTER VIDEO 4MHZ      |                 |          |
| KIT                              | \$345.95, A & T | \$425.95 |
| UPGRADE RAMS FOR VB-3            |                 | \$42.00  |
| 104 2 PARALLEL 2 SERIAL, PCBD    |                 | \$32.95  |
| KIT                              | \$155.95, A & T | \$194.95 |
| PB-1 2708, 2716 PROGRAMMER BOARD |                 |          |
| KIT                              | \$135.95, A & T | \$185.95 |
| MB-10 16K STATIC RAM             |                 |          |
| KIT                              | \$299.95, A & T | \$339.95 |
| <b>APPLE PRODUCTS</b>            |                 |          |
| A488 IEEE 488 INTERFACE          |                 | \$399.95 |
| A10 SERIAL/PARALLEL INTERFACE    |                 |          |
| KIT                              | \$125.95, A & T | \$155.95 |
| AS10 SERIAL I/O                  |                 |          |
| KIT                              | \$87.95, A & T  | \$97.95  |
| AP10 PARALLEL I/O W/O CABLES     |                 |          |
| KIT                              | \$67.95 A & T   | \$87.95  |

OTHER SSM PRODUCTS ARE AVAILABLE  
CALL FOR PRICES.

# MIKOS

MONDAY-FRIDAY, 8:00 TO 12:00, 1:00 TO 5:30  
THURSDAYS, 8:00 TO 9:00 P.M.  
(415) 728-9121  
P.O. BOX 955 • EL GRANADA, CA 94018  
PLEASE SEND FOR IC, XISTOR AND COMPUTER PARTS LIST

**MAR. SPECIAL SALE  
ON PREPAID ORDERS**  
(CHARGE CARDS, C.O.D. OR P.O.'S NOT AVAILABLE)

**MIKOS WIRE WRAP PROTOTYPE BOARD, ROOM FOR 5 REGULATORS, GLASS FILLED EPOXY, \$100, OVER 3000 HOLES, PLATED THROUGH HOLE, ALL EDGE CONNECTOR PINS NUMBERED AND LABELED.**

PCBD ..... \$27.95, 5 FOR ..... \$129.95

**74 LS' SERIES PRIME PARTS**

| EA 5 FOR       | EA 5 FOR        | EA 5 FOR        |
|----------------|-----------------|-----------------|
| LS00 .25 1.23  | LS132 .75 3.56  | LS197 .85 4.04  |
| LS02 .25 1.23  | LS136 .50 2.38  | LS221 1.15 5.46 |
| LS04 .25 1.23  | LS138 .75 3.56  | LS240 1.80 8.55 |
| LS05 .25 1.23  | LS139 .75 3.56  | LS243 1.75 8.31 |
| LS08 .35 1.66  | LS145 1.20 5.70 | LS244 1.75 8.31 |
| LS10 .25 1.23  | LS147 2.49      | LS245 2.15      |
| LS13 .45 2.14  | LS148 1.35      | LS251 1.00 4.75 |
| LS14 .99 4.50  | LS151 .75 3.56  | LS257 .85 4.04  |
| LS20 .25 1.23  | LS153 .75 3.56  | LS258 .85 4.04  |
| LS26 .35 1.66  | LS155 .90 4.28  | LS260 .65       |
| LS27 .35 1.66  | LS156 .90 4.28  | LS266 .46 2.19  |
| LS30 .25 1.23  | LS157 .75 3.56  | LS279 .50 2.38  |
| LS32 .35 1.66  | LS158 .75 3.56  | LS290 .80 3.80  |
| LS37 .55 2.50  | LS160 .90 4.28  | LS293 .80 3.80  |
| LS38 .35 1.66  | LS161 .95 4.51  | LS295 1.05 4.99 |
| LS42 .55 2.50  | LS162 .95 4.51  | LS367 .70 3.33  |
| LS74 .45 2.14  | LS163 .95 4.51  | LS368 .70 3.33  |
| LS75 .50 2.38  | LS164 .95 4.51  | LS373 1.85 8.79 |
| LS85 1.15 5.46 | LS166 1.75 8.31 | LS374 1.80 8.55 |
| LS86 .40 1.90  | LS173 .80 3.80  | LS377 1.45 6.89 |
| LS90 .60 2.85  | LS174 .95 4.51  | LS378 1.18 5.61 |
| LS92 .60 2.85  | LS175 .95 4.51  | LS620 2.25      |
| LS93 .60 2.85  | LS190 1.00 4.75 | LS626 2.25      |
| LS122 .45 2.14 | LS191 1.00 4.75 | LS629 1.44      |
| LS123 .95 4.50 | LS192 .85 4.04  | LS682 3.20      |
| LS125 .90 4.28 | LS193 .95 4.51  | LS683 2.30      |
| LS126 .75 3.56 | LS196 .85 4.04  | LS688 2.40      |

QUANTITY OF 5 FOR MUST BE OF THE SAME DEVICE. THEY MAY NOT BE MIXED. AN ADDITIONAL 5% OFF PURCHASE OVER \$50 ON LS PARTS ON PREPAID ORDERS BY CHECK OR MONEY ORDER ONLY.

VISA or MASTERCHARGE Send account number, interbank number, expiration date and sign your order. Approx. postage will be added. Orders with check or money order will be sent post paid in U.S. If you are not a regular customer, please use charge, cashier's check or postal money order. Otherwise there will be a two-week delay for checks to clear. Calif. residents add 6% tax. Money back 30-day guarantee. We cannot accept returned IC's that have been soldered to. Prices subject to change without notice. \$20 minimum order. \$2.00 service charge on orders less than \$20.00.

CIRCLE 14 ON FREE INFORMATION CARD



# DIGI-KEY 800-346-5144 CORPORATION

In Mn., Ak., HI, Call 218-681-6674

NATIONAL SEMICONDUCTOR • PANASONIC • QUALITY — Name brand products from nationally recognized manufacturers. CHEMICALS • ARIES • PLESSEY • MOLEX • E  
 AAVIP • CHEMVAL • BISHOP GRAPHICS • N. MACHINE • DIAMOND TOOL • UNGAR • GC CH  
 MOLEX • AAVIP • CHEMVAL • BISHOP GRAPHICS • N. MACHINE • DIAMOND TOOL • UNGAR • GC CH  
 OIL MACHINE • UNGAR • GC CHEMICALS • ARIES • PLESSEY • MOLEX • E  
 NATIONAL SEMICONDUCTOR • PANASONIC • SAVINGS — Volume Discounts • OEM Quantity Pricing • Toll Free 800 Number  
 SERVICE — Computerized order processing and inventory control. CHEMICALS • ARIES • PLESSEY • MOLEX • E  
 The Big DICKI-E Discount makes a Big Price Difference. **\$35.95** **\$24.95** **\$79.95**

## INTEGRATED CIRCUITS

**4116**  
 250 nsec 16,384! Dynamic Ram

| 7400 TTL | 74LS00 TTL | 74S00 TTL | Line # |
|----------|------------|-----------|--------|
| 7400     | 74LS00     | 74S00     | 1.00   |
| 7401     | 74LS01     | 74S01     | 1.00   |
| 7402     | 74LS02     | 74S02     | 1.00   |
| 7403     | 74LS03     | 74S03     | 1.00   |
| 7404     | 74LS04     | 74S04     | 1.00   |
| 7405     | 74LS05     | 74S05     | 1.00   |
| 7406     | 74LS06     | 74S06     | 1.00   |
| 7407     | 74LS07     | 74S07     | 1.00   |
| 7408     | 74LS08     | 74S08     | 1.00   |
| 7409     | 74LS09     | 74S09     | 1.00   |
| 7410     | 74LS10     | 74S10     | 1.00   |
| 7411     | 74LS11     | 74S11     | 1.00   |
| 7412     | 74LS12     | 74S12     | 1.00   |
| 7413     | 74LS13     | 74S13     | 1.00   |
| 7414     | 74LS14     | 74S14     | 1.00   |
| 7415     | 74LS15     | 74S15     | 1.00   |
| 7416     | 74LS16     | 74S16     | 1.00   |
| 7417     | 74LS17     | 74S17     | 1.00   |
| 7418     | 74LS18     | 74S18     | 1.00   |
| 7419     | 74LS19     | 74S19     | 1.00   |
| 7420     | 74LS20     | 74S20     | 1.00   |
| 7421     | 74LS21     | 74S21     | 1.00   |
| 7422     | 74LS22     | 74S22     | 1.00   |
| 7423     | 74LS23     | 74S23     | 1.00   |
| 7424     | 74LS24     | 74S24     | 1.00   |
| 7425     | 74LS25     | 74S25     | 1.00   |
| 7426     | 74LS26     | 74S26     | 1.00   |
| 7427     | 74LS27     | 74S27     | 1.00   |
| 7428     | 74LS28     | 74S28     | 1.00   |
| 7429     | 74LS29     | 74S29     | 1.00   |
| 7430     | 74LS30     | 74S30     | 1.00   |
| 7431     | 74LS31     | 74S31     | 1.00   |
| 7432     | 74LS32     | 74S32     | 1.00   |
| 7433     | 74LS33     | 74S33     | 1.00   |
| 7434     | 74LS34     | 74S34     | 1.00   |
| 7435     | 74LS35     | 74S35     | 1.00   |
| 7436     | 74LS36     | 74S36     | 1.00   |
| 7437     | 74LS37     | 74S37     | 1.00   |
| 7438     | 74LS38     | 74S38     | 1.00   |
| 7439     | 74LS39     | 74S39     | 1.00   |
| 7440     | 74LS40     | 74S40     | 1.00   |
| 7441     | 74LS41     | 74S41     | 1.00   |
| 7442     | 74LS42     | 74S42     | 1.00   |
| 7443     | 74LS43     | 74S43     | 1.00   |
| 7444     | 74LS44     | 74S44     | 1.00   |
| 7445     | 74LS45     | 74S45     | 1.00   |
| 7446     | 74LS46     | 74S46     | 1.00   |
| 7447     | 74LS47     | 74S47     | 1.00   |
| 7448     | 74LS48     | 74S48     | 1.00   |
| 7449     | 74LS49     | 74S49     | 1.00   |
| 7450     | 74LS50     | 74S50     | 1.00   |
| 7451     | 74LS51     | 74S51     | 1.00   |
| 7452     | 74LS52     | 74S52     | 1.00   |
| 7453     | 74LS53     | 74S53     | 1.00   |
| 7454     | 74LS54     | 74S54     | 1.00   |
| 7455     | 74LS55     | 74S55     | 1.00   |
| 7456     | 74LS56     | 74S56     | 1.00   |
| 7457     | 74LS57     | 74S57     | 1.00   |
| 7458     | 74LS58     | 74S58     | 1.00   |
| 7459     | 74LS59     | 74S59     | 1.00   |
| 7460     | 74LS60     | 74S60     | 1.00   |
| 7461     | 74LS61     | 74S61     | 1.00   |
| 7462     | 74LS62     | 74S62     | 1.00   |
| 7463     | 74LS63     | 74S63     | 1.00   |
| 7464     | 74LS64     | 74S64     | 1.00   |
| 7465     | 74LS65     | 74S65     | 1.00   |
| 7466     | 74LS66     | 74S66     | 1.00   |
| 7467     | 74LS67     | 74S67     | 1.00   |
| 7468     | 74LS68     | 74S68     | 1.00   |
| 7469     | 74LS69     | 74S69     | 1.00   |
| 7470     | 74LS70     | 74S70     | 1.00   |
| 7471     | 74LS71     | 74S71     | 1.00   |
| 7472     | 74LS72     | 74S72     | 1.00   |
| 7473     | 74LS73     | 74S73     | 1.00   |
| 7474     | 74LS74     | 74S74     | 1.00   |
| 7475     | 74LS75     | 74S75     | 1.00   |
| 7476     | 74LS76     | 74S76     | 1.00   |
| 7477     | 74LS77     | 74S77     | 1.00   |
| 7478     | 74LS78     | 74S78     | 1.00   |
| 7479     | 74LS79     | 74S79     | 1.00   |
| 7480     | 74LS80     | 74S80     | 1.00   |
| 7481     | 74LS81     | 74S81     | 1.00   |
| 7482     | 74LS82     | 74S82     | 1.00   |
| 7483     | 74LS83     | 74S83     | 1.00   |
| 7484     | 74LS84     | 74S84     | 1.00   |
| 7485     | 74LS85     | 74S85     | 1.00   |
| 7486     | 74LS86     | 74S86     | 1.00   |
| 7487     | 74LS87     | 74S87     | 1.00   |
| 7488     | 74LS88     | 74S88     | 1.00   |
| 7489     | 74LS89     | 74S89     | 1.00   |
| 7490     | 74LS90     | 74S90     | 1.00   |
| 7491     | 74LS91     | 74S91     | 1.00   |
| 7492     | 74LS92     | 74S92     | 1.00   |
| 7493     | 74LS93     | 74S93     | 1.00   |
| 7494     | 74LS94     | 74S94     | 1.00   |
| 7495     | 74LS95     | 74S95     | 1.00   |
| 7496     | 74LS96     | 74S96     | 1.00   |
| 7497     | 74LS97     | 74S97     | 1.00   |
| 7498     | 74LS98     | 74S98     | 1.00   |
| 7499     | 74LS99     | 74S99     | 1.00   |
| 7500     | 74LS100    | 74S100    | 1.00   |

## TEXAS INSTRUMENTS I.C. SOCKETS

**Solder Tail Single Board Dip Sockets**  
 Body — 94 V. polyimide with Copper Alloy contacts. Accommodates standard IC leads up to 0.014" thick and 0.020" wide. Contact is designed and limited to the underside to trap the broad "flange" of the IC case, allowing for "pop" insertion and high retention force. Socket is designed to achieve maximum density on boards.

**TIN Plated Solder Tail Single Board Low Profile Dip Sockets**  
 Body — 94 V. polyimide with Copper Alloy contacts. Accommodates standard IC leads up to 0.014" thick and 0.020" wide. Contact is designed and limited to the underside to trap the broad "flange" of the IC case, allowing for "pop" insertion and high retention force. Socket is designed to achieve maximum density on boards.

**GOLD Wire Solder Tail Single Board Low Profile Dip Sockets**  
 Body — 94 V. polyimide with Copper Alloy contacts. Accommodates standard IC leads up to 0.014" thick and 0.020" wide. Contact is designed and limited to the underside to trap the broad "flange" of the IC case, allowing for "pop" insertion and high retention force. Socket is designed to achieve maximum density on boards.

**WIRE WRAP DIP SOCKETS**  
 Standard configurations. Universal mounting and wire wrap compatibility. Contact width adjustable to 0.131" for use with standard wire wrap wire. Wire wrap wire is held in place by a 0.010" wide groove. All sockets are designed to achieve maximum density on boards.

**TIN PLATED WIRE WRAP DIP SOCKETS**  
 Standard configurations. Universal mounting and wire wrap compatibility. Contact width adjustable to 0.131" for use with standard wire wrap wire. Wire wrap wire is held in place by a 0.010" wide groove. All sockets are designed to achieve maximum density on boards.

**GOLD WIRE WRAP DIP SOCKETS**  
 Standard configurations. Universal mounting and wire wrap compatibility. Contact width adjustable to 0.131" for use with standard wire wrap wire. Wire wrap wire is held in place by a 0.010" wide groove. All sockets are designed to achieve maximum density on boards.

## TEXAS INSTRUMENTS GOLD EDGEBOARD CONNECTORS

**RELAY COST-EFFECTIVE CONTACT CONNECTORS**  
 (All Wire Wraps to be soldered into contact holes) — Copper plated, conformal surface design.

**WIRE SERIES 100'S 200'S EDGEBOARD CONNECTORS**  
 Standard configurations. Universal mounting and wire wrap compatibility. Contact width adjustable to 0.131" for use with standard wire wrap wire. Wire wrap wire is held in place by a 0.010" wide groove. All sockets are designed to achieve maximum density on boards.

**WIRE SERIES 133'S 250'S EDGEBOARD CONNECTORS**  
 Standard configurations. Universal mounting and wire wrap compatibility. Contact width adjustable to 0.131" for use with standard wire wrap wire. Wire wrap wire is held in place by a 0.010" wide groove. All sockets are designed to achieve maximum density on boards.

**WIRE SERIES 156'S 200'S EDGEBOARD CONNECTORS**  
 Standard configurations. Universal mounting and wire wrap compatibility. Contact width adjustable to 0.131" for use with standard wire wrap wire. Wire wrap wire is held in place by a 0.010" wide groove. All sockets are designed to achieve maximum density on boards.

**TEMPERATURE PROGRAMMABLE MODULE**  
 USE PROGRAMMABLE FOR:  
 1. Temperature measurement  
 2. Temperature control  
 3. Temperature compensation

**8085 MICROPROCESSOR REAL-TIME CLOCK/CALENDAR FEATURES**  
 1. Real-time clock  
 2. Calendar  
 3. Alarm  
 4. Interrupt

**THE "PROGRAMMABLE" CLOCK MODULES**  
 1. 1000 Hz  
 2. 100 Hz  
 3. 10 Hz  
 4. 1 Hz

## 3 AMP SILICON RECTIFIER

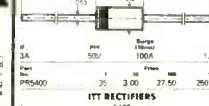

**150 CAPACITORS**  
 Price includes conversion from standard plastic to metal case for use with storage and back boxes.

**ITT RECTIFIERS**  
 2400  
 1. 2400  
 2. 2400  
 3. 2400

**ITT SILICON ZENER DIODES**  
 2000  
 1. 2000  
 2. 2000  
 3. 2000

**SILICON TRANSISTORS**  
 2000  
 1. 2000  
 2. 2000  
 3. 2000

**DIODES**  
 2000  
 1. 2000  
 2. 2000  
 3. 2000

**TRANSISTORS**  
 2000  
 1. 2000  
 2. 2000  
 3. 2000

**DIODES**  
 2000  
 1. 2000  
 2. 2000  
 3. 2000

**TRANSISTORS**  
 2000  
 1. 2000  
 2. 2000  
 3. 2000

**DIODES**  
 2000  
 1. 2000  
 2. 2000  
 3. 2000

**TRANSISTORS**  
 2000  
 1. 2000  
 2. 2000  
 3. 2000

**DIODES**  
 2000  
 1. 2000  
 2. 2000  
 3. 2000

**TRANSISTORS**  
 2000  
 1. 2000  
 2. 2000  
 3. 2000

**DIODES**  
 2000  
 1. 2000  
 2. 2000  
 3. 2000

**TRANSISTORS**  
 2000  
 1. 2000  
 2. 2000  
 3. 2000

## PANASONIC TSW Series Large Format Electrolytic Capacitors

**NEW! KIT**  
 2000  
 1. 2000  
 2. 2000  
 3. 2000

**PANASONIC POLYESTER CAPACITORS**  
 100 nsec 10% TOLERANCE  
 2000  
 1. 2000  
 2. 2000  
 3. 2000

**NEW! KIT**  
 2000  
 1. 2000  
 2. 2000  
 3. 2000

**PANASONIC METALLIZED POLYESTER CAPACITORS**  
 2000  
 1. 2000  
 2. 2000  
 3. 2000

**NEW! KIT**  
 2000  
 1. 2000  
 2. 2000  
 3. 2000

**PANASONIC TSW Series Large Format Electrolytic Capacitors**  
 2000  
 1. 2000  
 2. 2000  
 3. 2000

**NEW! KIT**  
 2000  
 1. 2000  
 2. 2000  
 3. 2000

**PANASONIC TSW Series Large Format Electrolytic Capacitors**  
 2000  
 1. 2000  
 2. 2000  
 3. 2000

**NEW! KIT**  
 2000  
 1. 2000  
 2. 2000  
 3. 2000

**PANASONIC TSW Series Large Format Electrolytic Capacitors**  
 2000  
 1. 2000  
 2. 2000  
 3. 2000

**NEW! KIT**  
 2000  
 1. 2000  
 2. 2000  
 3. 2000

**PANASONIC TSW Series Large Format Electrolytic Capacitors**  
 2000  
 1. 2000  
 2. 2000  
 3. 2000

**NEW! KIT**  
 2000  
 1. 2000  
 2. 2000  
 3. 2000

**PANASONIC TSW Series Large Format Electrolytic Capacitors**  
 2000  
 1. 2000  
 2. 2000  
 3. 2000

**NEW! KIT**  
 2000  
 1. 2000  
 2. 2000  
 3. 2000

## PANASONIC TSW Series Large Format Electrolytic Capacitors

**NEW! KIT**  
 2000  
 1. 2000  
 2. 2000  
 3. 2000

**PANASONIC POLYESTER CAPACITORS**  
 100 nsec 10% TOLERANCE  
 2000  
 1. 2000  
 2. 2000  
 3. 2000

**NEW! KIT**  
 2000  
 1. 2000  
 2. 2000  
 3. 2000

**PANASONIC METALLIZED POLYESTER CAPACITORS**  
 2000  
 1. 2000  
 2. 2000  
 3. 2000

**NEW! KIT**  
 2000  
 1. 2000  
 2. 2000  
 3. 2000

**PANASONIC TSW Series Large Format Electrolytic Capacitors**  
 2000  
 1. 2000  
 2. 2000  
 3. 2000

**NEW! KIT**  
 2000  
 1. 2000  
 2. 2000  
 3. 2000

**PANASONIC TSW Series Large Format Electrolytic Capacitors**  
 2000  
 1. 2000  
 2. 2000  
 3. 2000

**NEW! KIT**  
 2000  
 1. 2000  
 2. 2000  
 3. 2000

**PANASONIC TSW Series Large Format Electrolytic Capacitors**  
 2000  
 1. 2000  
 2. 2000  
 3. 2000

**NEW! KIT**  
 2000  
 1. 2000  
 2. 2000  
 3. 2000

**PANASONIC TSW Series Large Format Electrolytic Capacitors**  
 2000  
 1. 2000  
 2. 2000  
 3. 2000

**NEW! KIT**  
 2000  
 1. 2000  
 2. 2000  
 3. 2000

**PANASONIC TSW Series Large Format Electrolytic Capacitors**  
 2000  
 1. 2000  
 2. 2000  
 3. 2000

**NEW! KIT**  
 2000  
 1. 2000  
 2. 2000  
 3. 2000

## PANASONIC TSW Series Large Format Electrolytic Capacitors

**NEW! KIT**  
 2000  
 1. 2000  
 2. 2000  
 3. 2000

**PANASONIC POLYESTER CAPACITORS**  
 100 nsec 10% TOLERANCE  
 2000  
 1. 2000  
 2. 2000  
 3. 2000

**NEW! KIT**  
 2000  
 1. 2000  
 2. 2000  
 3. 2000

**PANASONIC METALLIZED POLYESTER CAPACITORS**  
 2000  
 1. 2000  
 2. 2000  
 3. 2000

**NEW! KIT**  
 2000  
 1. 2000  
 2. 2000  
 3. 2000

**PANASONIC TSW Series Large Format Electrolytic Capacitors**  
 2000  
 1. 2000  
 2. 2000  
 3. 2000

**NEW! KIT**  
 2000  
 1. 2000  
 2. 2000  
 3. 2000

**PANASONIC TSW Series Large Format Electrolytic Capacitors**  
 2000  
 1. 2000  
 2. 2000  
 3. 2000

**NEW! KIT**  
 2000  
 1. 2000  
 2. 2000  
 3. 2000

**PANASONIC TSW Series Large Format Electrolytic Capacitors**  
 2000  
 1. 2000  
 2. 2000  
 3. 2000

**NEW! KIT**  
 2000  
 1. 2000  
 2. 2000  
 3. 2000

**PANASONIC TSW Series Large Format Electrolytic Capacitors**  
 2000  
 1. 2000  
 2. 2000  
 3. 2000

**NEW! KIT**  
 2000  
 1. 2000  
 2. 2000  
 3. 2000

**PANASONIC TSW Series Large Format Electrolytic Capacitors**  
 2000  
 1. 2000  
 2. 2000  
 3. 2000

**NEW! KIT**  
 2000  
 1. 2000  
 2. 2000  
 3. 2000

## TANT



# VIDEO DISCOUNTS

**TEKNIKA WIRELESS REMOTE CONTROL TV TUNER**  
**\$110.00** ea.

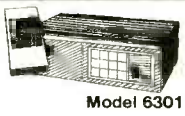

**PHILIPS REMOTE TV CONVERTER**  
 Wireless Remote Control 40 Channels  
**139.95** ea. **125.00** ea. (4 or more)



**36 CHANNEL UP CONVERTER FOR TV & VTR Cable VHF to UHF**  
 Model V5736  
 1-3 pieces **\$29.95** ea.  
 4 pieces & up **\$24.95** ea.

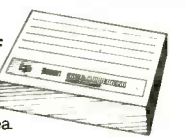

**VIDEO SWITCHER**  
 Model V 4801 **\$29.95** ea.  
 Flip a switch to watch a program on any channel, while simultaneously recording a program on any cable or pay TV channel - or vice versa. Plus, you can use your recorder's programming feature to record TV programs while you're away.



**VIDEO CONTROL CENTER**  
 Model IV 4802 **\$39.95** ea.  
 Provides remote control access of all your Video, TV or Cable inputs to your TV set or Big Screen TV from one convenient location by merely flipping a switch.

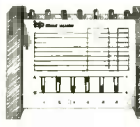

**COAXIAL SWITCHING FOR TV VIDEO CASSETTE RECORDERS**  
 Model AB-370 **\$6.95** ea.  
 3-position coaxial push-button switch.

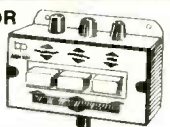

**COAX AB SWITCHES**  
 Model AB-27 **\$2.95** ea.  
 • Input: 75 ohm. • Output: 75 ohm.

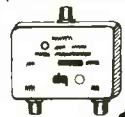

Model AB-28 **\$2.95** ea. Model AB-29 **\$2.95** ea.  
 • Input: 75 ohm. • Output: 300 ohm. • Input: 75 & 300 ohm.

**ANTENNA/CABLE TV SWITCH**  
 Model AB-400 **\$10.95** ea.

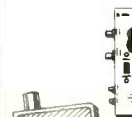

**ANTENNA/CABLE TV SWITCH**  
 Model AB-410 **\$9.95** ea.  
 • Switches from cable to antenna system instantly. • Accepts 75 or 300 ohm inputs.



**TV GATE SWITCH**  
 Model IV 450 **\$2.95**  
 300 ohm in and out with RCA plug.

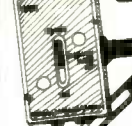

**COAXIAL SWITCH**  
 Model DCS-A/B **\$7.95**  
 A versatile product, with a range of consumer and MATV applications.



## VHF/FM AMPLIFIERS

Model 7002 **\$9.95** ea.  
 • All solid state signal amplifier boosts weak signals. For 2 sets.

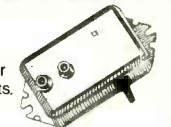

Model 7004 **\$12.95** ea.  
 • For up to 4 sets • Signal gain 3 dB

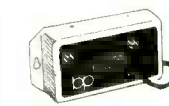

**DISTRIBUTION AMPLIFIER VHF/UHF FM**  
 With FM Trap  
 Model DA-425 **\$29.95** ea.  
 • Designed for TV/VCR multiple-set installations.

**QUICK CONNECT "F" PLUG & BALUN**

Model IV 400 **\$1.50** ea.  
 10 for \$12.50



**QUICK CONNECT "F" PLUG**  
 Model IV 403 **.75**  
 10 for \$6.00  
 For 75 ohm cable. No wiring necessary.



**QUICK CONNECT "F" PLUG RG 59U**  
 Model IV 4036 **\$2.50** ea.  
 6 ft.



## VHF/UHF MATCHING TRANSFORMERS

Model MT-1 **.75** ea.  
 10 for \$6.00  
 VHF/UHF 75-300 ohm matching unit. Miniature size completely shielded and balanced for reduction of direct pick-up.



Model MT-2 **\$1.10** ea.  
 10 for \$9.00  
 Completely plastic molded construction for weather-proofing. Supplied with rubber boot.

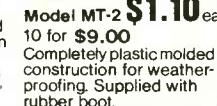

# FORDHAM

855 Conklin St., Farmingdale, N.Y. 11735  
 ■ Master Charge ■ BankAmericard  
 ■ Visa ■ COD ■ Check ■ Money Order

**TOLL FREE (800) 645-9518**  
 in N.Y. State call (516) 752-0050

**COMPUTERS**  
**ATARI 800™ COMPUTER SYSTEM**  
 16k → **\$750.00**  
 48k → **\$898.00**  
 "APPLE II Plus"  
 48k → ~~\$1199.00~~  
 64k → ~~\$1399.00~~  
**ATARI Software**  
 Missile Command  
 Asteroids  
 Star Raiders  
 Chess  
 All **\$36.00/ea.**

**REAL-TIME CLOCK CALENDAR (MSM 5832)**  
 Features:  
 • Time Month, Date, Year, & Day of Week  
 • Blue Oriented  
 • 1 Bit Data Bus  
 • 1 Bit Address  
 • R/W Hold Select.  
**\$7.45**  
 XTAL **\$2.85**  
 • Inter. Signal  
 • 32 768KHz.ystal Control  
 • 5v. Pow. Sup.  
 • Low Power Dissipation

**No "Glitches", Surges Or Interference**  
 THE MPD117 TAKES AN ORDINARY OUTLET INTO A CONTROLLED FILTERED POWER SOURCE!  
**MPD 117 \$79.50**

**DISKETTE «SALE»**  
 Wabash:  
 5 1/4 → 10/ **\$24.95**  
 Binch → 10/ **\$27.95**  
 Call For Quant.  
**!PRICING! \$¢**

**★SPECIALS★**  
**ZEMITH ZYM-121 Video Monitor: Green Phosphor**  
 12 inch. 15+Mhz. → **\$129.00**  
 3inch MUFFIN FAN w/cord → **\$9.95**  
 UPD 765: Floppy Disk Cont. → **\$9.95**  
 8155- RAM → **\$11.50**  
 8255- PPI → **\$7.95**  
 2111- Static RAM → **\$1.75**  
 8085A CPU → **\$8.50**  
 MC 6800- CPU → **\$7.75**  
 ER 2501- EAROM → **4.95**  
 AY3-8603 → **\$4.95**  
 6402 → **\$6.50**  
 6802 → **\$9.50**  
 6502 → **\$6.50**  
 6810 → **\$3.95**  
 6821 → **\$4.95**  
 8279 → **\$12.50**

**MONITORS**  
**AMDEK Corp.**  
 12in. B/W → **\$129.00**  
 12in. Green → **\$155.00**  
 13in. Color → **\$365.00**

**☆ADDS☆**  
**VIEWPOINT TERMINAL**  
**\$579.00**

**CONCORD COMPUTER PRODUCTS**  
 1971 SO. STATE COLLEGE ANAHEIM, CALIF. 92806  
 (714) 937-0637  
 CHECK - M/O NO COD  
 \$10. MIN ORDER/ CA RES. ADD 6% FRT  
 10-49 \$2.00 250 499 \$9.00  
 50-99 4.00 500 999 11.00  
 100-240 8.00 1000 UP CALL

**COMPONENTS**

|         |    |          |     |       |      |        |      |
|---------|----|----------|-----|-------|------|--------|------|
| SN7400N | 22 | SN7482N  | 30  | 74900 | 39   | 74S138 | 75   |
| SN7402N | 18 | SN7482N  | 48  | 74902 | 45   | 74S140 | 1.00 |
| SN7404N | 21 | SN7483N  | 45  | 74903 | 38   | 74S158 | .75  |
| SN7408N | 22 | SN7489N  | 90  | 74904 | 30   | 74S174 | 1.35 |
| SN7410N | 18 | SN7490N  | 28  | 74905 | 30   | 74S175 | 1.35 |
| SN7412N | 20 | SN7412N  | 30  | 74910 | 39   | 74S182 | .75  |
| SN7413N | 22 | SN74138N | 95  | 74915 | 45   | 74S186 | 4.25 |
| SN7414N | 29 | SN74141N | 99  | 74920 | 55   | 74S201 | 6.75 |
| SN7416N | 27 | SN74151N | 65  | 74922 | 55   | 74S240 | 2.75 |
| SN7417N | 29 | SN74153N | 95  | 74930 | 75   | 74S944 | 2.95 |
| SN7420N | 17 | SN74154N | 125 | 74937 | 55   | 74S251 | 2.75 |
| SN7425N | 20 | SN74155N | 75  | 74950 | 65   | 74S287 | 2.95 |
| SN7430N | 17 | SN74157N | 58  | 74951 | 49   | 74S288 | 2.95 |
| SN7437N | 26 | SN74160N | 99  | 74954 | 55   | 74S290 | 5.75 |
| SN7438N | 24 | SN74161N | 85  | 74974 | 65   | 74S470 | 9.25 |
| SN7440N | 18 | SN74163N | 87  | 74986 | 65   | 74S471 | 9.25 |
| SN7442N | 45 | SN74164N | 81  | 74988 | 1.95 | 74S473 | 9.50 |
| SN7443N | 42 | SN74165N | 55  | 74989 | 1.45 | 74S474 | 9.50 |
| SN7445N | 84 | SN74174N | 88  | 74990 | 1.45 |        |      |
| SN7451N | 19 | SN74175N | 79  |       |      |        |      |
| SN7454N | 19 | SN74180N | 75  |       |      |        |      |
| SN7474N | 27 | SN74181N | 115 |       |      |        |      |
| SN7475N | 35 | SN74383N | 106 |       |      |        |      |

**74LS00**

|         |    |         |     |           |      |             |       |
|---------|----|---------|-----|-----------|------|-------------|-------|
| 74LS00  | 28 | 74LS158 | 89  | 2102      | .85  | 1103A       | .75   |
| 74LS02  | 28 | 74LS161 | 83  | 4508S     | .95  | UPD765      | 19.95 |
| 74LS03  | 28 | 74LS162 | 88  | 8038      | 2.95 | Floppy disk | w/... |
| 74LS04  | 28 | 74LS163 | 98  | MS565     | .27  | controller  | w/... |
| 74LS05  | 22 | 74LS164 | 86  | AYS-1013A | 4.25 | ULH2001     | 1.95  |
| 74LS08  | 29 | 74LS165 | 86  | 1488      | .95  | TMS4400     | 1.40  |
| 74LS09  | 28 | 74LS169 | 156 | 1489      | 1.30 | MC4008P     | 1.50  |
| 74LS10  | 28 | 74LS170 | 175 | 8726      | 1.30 | MC4026      | 1.55  |
| 74LS14  | 89 | 74LS174 | 85  | 8212      | 1.95 | D3024       | 1.95  |
| 74LS20  | 22 | 74LS175 | 85  | 8216      | 1.95 | D3001       | 1.95  |
| 74LS21  | 26 | 74LS190 | 85  | 8218      | .85  | D3002       | 1.95  |
| 74LS26  | 40 | 74LS191 | 125 | 8216      | .85  |             |       |
| 74LS27  | 17 | 74LS195 | 86  | 2102      | .85  |             |       |
| 74LS28  | 37 | 74LS197 | 75  | 4508S     | .95  |             |       |
| 74LS30  | 29 | 74LS221 | 125 | 8038      | 2.95 |             |       |
| 74LS32  | 31 | 74LS240 | 165 | MS565     | .27  |             |       |
| 74LS38  | 31 | 74LS241 | 165 | AYS-1013A | 4.25 |             |       |
| 74LS42  | 83 | 74LS243 | 156 | 1488      | .95  |             |       |
| 74LS48  | 77 | 74LS244 | 156 | 1489      | 1.30 |             |       |
| 74LS74  | 36 | 74LS245 | 245 | 8726      | 1.30 |             |       |
| 74LS75  | 56 | 74LS251 | 125 | 8212      | 1.95 |             |       |
| 74LS86  | 45 | 74LS253 | 86  | 8216      | 1.95 |             |       |
| 74LS90  | 58 | 74LS257 | 86  | 8218      | .85  |             |       |
| 74LS93  | 65 | 74LS259 | 195 | 2102      | .85  |             |       |
| 74LS98  | 80 | 74LS280 | 56  | 4508S     | .95  |             |       |
| 74LS107 | 43 | 74LS273 | 155 | 8038      | 2.95 |             |       |
| 74LS110 | 45 | 74LS278 | 45  | MS565     | .27  |             |       |
| 74LS122 | 45 | 74LS290 | 125 | AYS-1013A | 4.25 |             |       |
| 74LS123 | 89 | 74LS293 | 195 | 1488      | .95  |             |       |
| 74LS125 | 89 | 74LS386 | 86  | 1489      | 1.30 |             |       |
| 74LS126 | 79 | 74LS387 | 75  | 8726      | 1.30 |             |       |
| 74LS138 | 64 | 74LS373 | 145 | 8212      | 1.95 |             |       |
| 74LS139 | 59 | 74LS376 | 145 | 8216      | 1.95 |             |       |
| 74LS151 | 49 | 74LS377 | 125 | 8218      | .85  |             |       |
| 74LS153 | 49 | 74LS689 | 155 | 2102      | .85  |             |       |
| 74LS177 | 99 | 74LS670 | 180 | 4508S     | .95  |             |       |

**Bare Bones APPLE II**  
 W/O Keyboard **\$450**  
 W/O Pwr. Supply

|                 |        |
|-----------------|--------|
| Z-80            | 9.95   |
| Z-80A CTC       | 10.50  |
| Z-80A CPU       | 10.50  |
| Z-80 002 16 64K | 129.00 |
| 8088A           | 13.90  |
| 2801A           | 7.50   |
| MC9800          | 9.50   |

RADIO-ELECTRONICS



# HAMEG Oscilloscopes to meet every need

20 MHz  
DUAL TRACE

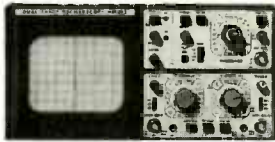

The high performance of the HM203 has been achieved by the optimum use of both discrete semiconductor and integrated circuit technology. Quality and long term reliability are assured through the use of high quality components throughout this instrument. Each unit is supplied with a comprehensive manual which includes operating and servicing instructions, circuit diagrams, and PCB layouts.

- DC-20 MHz
- 8 x 10cm Display
- Triggering up to 30 MHz

HM203 ..... \$580.00  
HM203N ..... \$600.00

## TG105 PULSE GENERATOR



- Period: 200nsec to 200ms (5MHz to 5Hz)
- Pulse Width: 100nsec to 100ms
- 50 ohm output range: 0.1V-10V
- TTL output
- Sync. output
- Operating Modes: Run, External trigger.
- External gate, Manual 1-shot or Gate
- Compliment and square wave

TG105 ..... Reg. Price \$219.00  
★ SPECIAL WITH COUPON \$195.00★

ANCRONA P.O. Box 2208R, Culver City, CA 90230

# ★ SPECIAL ★ COUPON

Bring this Coupon into one of our stores or mail to our Mail Order address shown below and receive the Special Discounts listed on this page with purchases of \$50.00 or more.  
**Offer EXPIRES on April 30, 1982**

NAME \_\_\_\_\_  
ADDRESS \_\_\_\_\_  
CITY \_\_\_\_\_ STATE \_\_\_\_\_  
ZIP \_\_\_\_\_ PHONE \_\_\_\_\_  
Coupons accepted only with full name and address filled in

## MICROPROCESSOR CONTROLLED EPROM PROGRAMMER



PROGRAMS  
VERIFIES  
TESTS - COPIES

□ 2516 □ 2716 □ 2732 □ 2732A

The K2578 EPROM Programmer is a microprocessor based standalone unit complete with power supply, housing and test socket. The unit comes standard with 16Kbit RAM (2K byte), and is expandable to 32Kbit (4K byte). It has a crystal controlled clock and requires no personality modules. It will program, test, copy or verify the EPROMs listed above.

Model K2578 Regular \$649.95 ... Special with Coupon \$525.95  
Model K2578-Kit Regular \$549.95 ... Special with Coupon \$425.95

## Capacitance Meter

- Easy to use - plug in capacitor, push range button and read the value to 0.1%
- 0.5 n. liquid crystal display
- Exclusive "Charge/Dvolt" measurement circuit (patent pending) holds ±0.1% basic accuracy for a full year.
- Up to 200 hrs operation on standard 9V Batt.
- 8 easy pushbutton ranges cover 0.1pf to 1959 microfarads.
- Best of all it's easy on the budget - only



MODEL 938 \$185

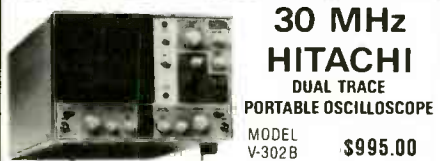

30 MHz  
HITACHI  
DUAL TRACE  
PORTABLE OSCILLOSCOPE

MODEL V-302B \$995.00

More sensitive to your input

★ SPECIAL WITH COUPON \$796.00★

## Universal Oscilloscope

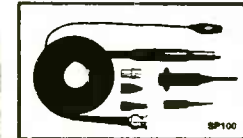

Probe  
\$36.00

**SWITCHABLE X1 and X10 Attenuation Factor**  
KEY ADDITIONAL FEATURES: • 100MHz bandwidth • Heavy duty tip • Break resistant center conductor • Slender, flexible cable • 6ft cable length • Wide compensation range • Fits all scopes • Ground reference can be activated at tip • Includes SPRING HOOK, I.C. TIP, BNC ADAPTOR, INSULATING TIP and TRIMMER TOOL ACCESSORIES

**ANCRONA**  
P.O. BOX 2208R, CULVER CITY, CA 90230  
STORES DO NOT ACCEPT MAIL ORDERS  
**MAIL ORDER**  
PHONE ORDERS: (213) 641-4064

Minimum Order \$10.00. Add \$2.00 to cover postage and handling. Master Charge and VISA welcomed. Please include your charge card number, interbank number and expiration date. Some items are subject to prior sale. Not responsible for typos. Store pricing may vary from Mail Order pricing. We reserve the right to substitute manufacturer.

## The Sound Choice from KEITHLEY

A smart choice for field service, the 128 beeper DMM is designed for the real world of hard knocks. The audible tone allows rapid troubleshooting. Use it for continuity checks, logic levels or hot tests. Designed for maximum full function flexibility, the 128 is loaded with practical capabilities, not expensive frills.



Model 128  
only \$139.00  
Case/Stand ... \$10.00

See/hear display includes a large, 0.6" LCD, over/under array and audible tone.

Beeper operates on all 5 functions — ACV, DCV, ACA, DCA, Ohms — and on all ranges for each function.

Special diode test range permits testing of LEDs and multiple junction components such as darlings.

Unique adjustable beeper threshold can be user-set to suit the different requirements of various applications.

Meter maintains 10M Ohm input resistance even with the beeper on.

Synetec Systems  
SYM-1  
\$239.00

**ANCRONA HAS MOTOROLA SEMICONDUCTORS**

|           |        |            |        |           |         |          |        |
|-----------|--------|------------|--------|-----------|---------|----------|--------|
| BFR90     | \$1.91 | MC1373P    | \$5.19 | MC6808P   | \$13.90 | M0A100A  | \$2.05 |
| BFR91     | 2.42   | MC1391P    | 1.44   | MC6809P   | 18.85   | M0A101A  | 2.21   |
| CA3064    | 1.54   | MC1408L6   | 3.84   | MC6821P   | 4.54    | MDA200   | 2.21   |
| CA3059    | 3.34   | MC1408L8   | 6.55   | MC6840P   | 8.73    | MDA204   | 2.67   |
| CA3079    | 2.23   | MC1455P1   | .99    | MC6845P   | 19.90   | MDA206   | 2.99   |
| DAC09CP   | 3.49   | MC1458CP-1 | 1.08   | MC6847P   | 16.06   | MDA2501  | 4.19   |
| MB0101    | .73    | MC1458P1   | 1.08   | MC8250L   | 11.31   | MDA2502  | 4.32   |
| MB0102    | .88    | MC1488L    | 1.68   | MC8505P   | 4.40    | MDA2504  | 4.58   |
| MB0201    | 1.03   | MC1489AL   | 1.89   | MC8522P   | 5.45    | MDA3500  | 4.46   |
| MB0501    | 1.57   | MC1489L    | 1.68   | MC8600P   | 12.92   | MDA3502  | 4.71   |
| MC1310P   | 6.29   | MC1496G    | 2.07   | MC875L    | 13.49   | MEJ3055T | 1.29   |
| MC1330A1P | 2.20   | MC3325P    | 2.10   | MC10116P  | .92     | MOC3010  | 1.91   |
| MC1349F   | 1.72   | MC3340P    | 2.10   | MC14412VP | 15.53   | MOC3011  | 2.27   |
| MC1350P   | 1.44   | MC4024P    | 6.59   | MC14459P  | 3.96    | MOC3031  | 2.93   |
| MC1358F   | 1.91   | MC6800P    | 8.73   | MC16674P  | 11.17   | MRF901   | 3.15   |
| MC1372P   | 6.48   | MC6802P    | 10.13  | MCRI03    | .79     | MRF911   | 3.04   |

★ SPECIAL 20% DISCOUNT WITH COUPON ★

**Z-80 SERIES MICROPROCESSOR IC's**

|          |           |            |         |             |         |
|----------|-----------|------------|---------|-------------|---------|
| 2.5 MHz  | Z-80-DART | \$14.30    | 4.0 MHz | Z-80A-DART  | \$15.50 |
| Z-80-CPU | \$7.10    | Z-80-S10/0 | 20.10   | Z-80A-CPU   | \$8.05  |
| Z-80-CTC | 5.90      | Z-80-S10/9 | 14.50   | Z-80A-CTC   | 6.35    |
| Z-80-P10 | 5.90      | Z80-DMA    | 21.50   | Z-80A-S10/9 | 15.70   |
|          |           | Z-80A-P10  | 6.35    | Z-80A-DMA   | 22.70   |

★ SPECIAL 20% DISCOUNT WITH COUPON ★

**6500 SERIES MICROPROCESSOR IC's**

|             |         |             |        |             |        |
|-------------|---------|-------------|--------|-------------|--------|
| A = (2 MHz) |         | B = (3 MHz) |        | C = (4 MHz) |        |
| P6502       | \$ 8.82 | P6506A      | \$8.82 | P6520A      | \$3.74 |
| P6502A      | 9.66    | P6507       | 8.09   | P6820       | 3.40   |
| P6502B      | 15.02   | P6507A      | 8.82   | P6820B      | 3.74   |
| P6502C      | 21.00   | P6512       | 8.82   | P6521       | 4.90   |
| P6503       | 8.09    | P6512A      | 9.66   | P6521A      | 5.34   |
| P6503A      | 8.82    | P6513       | 8.09   | P6821       | 4.90   |
| P6504       | 8.09    | P6513A      | 8.82   | P6821B      | 5.34   |
| P6504A      | 8.82    | P6514       | 8.09   | P6522       | 8.40   |
| P6505       | 8.09    | P6514A      | 8.82   | P6822A      | 11.24  |
| P6505A      | 8.82    | P6515       | 8.09   | P6530-004   | 15.84  |
| P6506       | 8.09    | P6520       | 3.40   | P1793-02    | 40.00  |

★ SPECIAL 20% DISCOUNT WITH COUPON ★

## MINIATURE DOT MATRIX IMPACT PRINTER

MODEL DP-822



## The Unique New Printer That Gives You All These Exciting Features.

- Low Cost
- Disposable printing head
- Simple interface
- Handles any type font
- Needs only one 12-volt DC power supply
- Uses standard 2 1/4" adding machine tape or carbonless paper
- 21-column printing at 25 lines per second
- Easy to install and maintain

Model DP-822 \$80.00

★ SPECIAL \$70.00 WITH COUPON ★

Dot Matrix Printer Control/Drive Card  
Model DP-822-08B \$125.00

**SD SYSTEMS Z-80 STARTER KIT**  
A COMPLETE MICRO-COMPUTER ON A BOARD  
Regular \$401.00  
★ SPECIAL with COUPON ★ \$368.00

- FEATURES**
- Z-80 CPU with 158 instructions
  - On-Board Keyboard and Display
  - On-Board PROM Programmer for PROMS (2716, 2758, T12516)
  - Kansas City Standard Cassette Int
  - Simple Key Controlled Audio Cassette Load and Dump
  - Expansion Provision for Mounting Two S-100 Connectors
  - Wire Wrap Area for Custom Circuitry
  - Single Step through RAM or PROM
  - Memory Examine and Change
  - Port Examine and Change
  - Z-80 CPU Register and Change
  - 2K Byte ZBUG Monitor in ROM
  - 1K Bytes of RAM (expandable to 2K)
  - 4 Channel Hardware Counter/Timer
  - Two Bi-Directional 8-Bit I/O Ports
  - Up to 5 Programmable Breakpoints
  - Switch Selectable PROM or Monitor Restart
  - Vectored Interrupts provided by Z-80-CTC and Z-80-P10

## Full ASCII Encoded Keyboards

**RCA 128-Character, 58-Key Typewriter Format for Alphanumeric Entry**

- VP-501 8-bit parallel output ... \$69.00
- VP-605 Async serial output ... \$99.00

**58-Key Typewriter Format Plus Calculator-Type Keypad for Fast Numeric Entry**

- VP-611 8-bit parallel output ... \$89.00
- VP-616 Asynchronous serial output ... \$119.00

Operation From Single +5 Volt Supply

VISIT A STORE NEAR YOU TODAY - We stock a large selection of Technical Books, Discrete Components, Integrated Circuits, Test Equipment and Electronic Supplies.

|   |  |  |  |   |   |   |
|---|--|--|--|---|---|---|
| <b>ATLANTA</b><br>3330 Piedmont Rd. N.E.<br>Atlanta, GA 30305<br>(404) 261-7100 | <b>CULVER CITY</b><br>11080 Jefferson Blvd.<br>Culver City, CA 90230<br>(213) 390-3595 | <b>HOUSTON</b><br>2649 Richmond<br>Houston, TX 77098<br>(713) 529-3489 | <b>PORTLAND</b><br>1125 N.E. 82nd Ave.<br>Portland, OR 97220<br>(503) 257-9464 | <b>SANTA ANA</b><br>1300 E. Edinger Ave.<br>Santa Ana, CA 92705<br>(714) 547-8424 | <b>SUNNYVALE</b><br>1054 E. El Camino Real<br>Sunnyvale, CA 94087<br>(408) 243-4121 | <b>TUCSON</b><br>4518 E. Broadway<br>Tucson, AZ 85711<br>(602) 881-2348 |
|---|--|--|--|---|---|---|



# MORE GAIN THAN A VARACTOR UHF TUNER

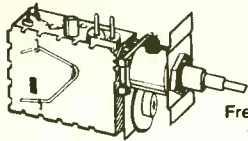

We start with a Mechanical UHF Tuner, add 2 coils and a diode, then peak it on our Spectrum Analyzer for maximum gain.

Frequency Range 470-899 MHz channels 14-83  
Output Channel 3. Available on request:  
Ch 2 or 4.

| PART NO. | DESCRIPTION  | PRICE   |
|----------|--|---------|
| B20      | Modified High Gain UHF Tuner   | \$15.00 |
| B21      | Pre-Drilled circuit board, screen printed layout, soldermask on foil side, needs only one jumper   | \$17.00 |
| B22      | Complete parts kit includes: All resistors (30), PCB Potentiometers (1-5K, 3-10K), Power Transformer (1A/24v), Panel Mount Potentiometer (10K), Integrated Circuits (7), Diodes (4), Voltage Regulator, Heat Sink, Electrolytic Capacitors (6), Disc Capacitors (35), Variable Capacitors (4), Coil Kit with #26 wire (4), IC Sockets (4-8 pin, 3-14 pin), Speaker (4", 3 oz), Standoffs, Hookup Wire, All misc. Hardware and the most complete and comprehensive 17 page instruction manual we have seen. All items individually packaged | \$80.00 |

When ordering 3 above items ..... \$110.00  
Order 5 each of the 3 items ..... \$ 95.00/set  
Order 10 each of the 3 items ..... \$ 85.00/set

| ACCESSORIES, AMPLIFIERS |   |
|-------------------------|---|
| A02                     | New 2 stage 28 db gain amplifier Kit \$18.00<br>Assembled \$25.00 |
| A03                     | New 14 db Gain single stage amp Kit \$10.50<br>Assembled \$15.50  |
| A04                     | 75-300 ohm matching transformer \$ 1.15                           |
| F-59                    | Coaxial connectors \$ 0.35  |

Mail order only.  
Send check or money order to:  
**GILCO INTERNATIONAL, INC.**  
P.O. Box 8817,  
Coral Gables, FL 33124  
Tel. (305) 823-5891 For COD orders

Minimum order \$25.00.  
Add 10% shipping and handling.  
Florida orders will not be accepted.  
For orders over \$50, Add 5%.

# MICROWAVE TV CONVERTERS

MODEL DCV-1-A

DOWN CONVERTER/ANTENNA  
COMBINATION

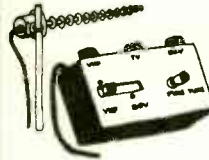

- 2 MICROWAVE PREAMP STAGES for maximum gain
- ONE PIECE CONSTRUCTION simplifies installation
- ALUMINUM AND ZINC PLATED STEEL for durability
- BUILT IN A/B SWITCH with more than 95dB isolation
- 2.1-2.8 GHz Covers all ham, commercial and ITFS channels

Years of enjoyment are yours with our model DCV-1-A. Two preamp stages coupled with the yagi antenna/housing provide a typical system gain of 53dB.

ASSEMBLED & TESTED  
LIST - \$175.00

**ONLY**  
**\$149.95**

INTRODUCTORY PRICE

YOU GET: 75' downlead  
3' jumper  
300 ohm matching transformer  
detailed instructions

WE CARRY A COMPLETE LINE INCLUDING PARABOLICS

DEALER INQUIRIES INVITED

**TRITON**  
MARKETING CORP.

1933 ROCKAWAY PARKWAY  
BROOKLYN, N.Y. 11238

**212-531-9004**



**FREE!**  
1982  
DISCOUNT  
ELECTRONICS  
CATALOG

JOIN THE PAK!

Send for our Free catalog and become a member of our exclusive Pak. Our members receive Poly Paks' exciting catalog several times a year. We offer: Penny Sales, Free Premiums and Low, Low Prices on a wide variety of Electronic Products such as Computer Peripherals, Integrated Circuits, Speakers, Audio Equipment, Rechargeable Batteries, Solar Products, Semiconductors, and much, much more! Take advantage of our 25 years as America's foremost Supplier of discount electronics.

Over  
4.5 Million  
Satisfied  
Customers

RUSH ME YOUR FREEDISCOUNT CATALOG!

NAME: \_\_\_\_\_  
ADDRESS: \_\_\_\_\_  
CITY: \_\_\_\_\_  
STATE: \_\_\_\_\_ ZIP: \_\_\_\_\_

CLIP AND MAIL COUPON TODAY TO:

**POLY PAKS, INC.**

P.O. Box 942, RA-3  
S. LYNNFIELD, MA. 01940

(617) 245-3828

Limited time, Introductory offer!

Assembled  
~~\$298.95~~  
\$249.95  
KIT  
~~\$249.95~~  
\$219.95



## PACCOM 8085 A TRAINING UNIT

Rated Best Value by instructors!

LEARN COMPUTING FROM THE GROUND UP!

- Design and code microprocessor software.
- Use logic and bit manipulation techniques.
- Enter and execute programs on your own computer.
- Understand microprocessor architecture.
- Control programmable input/output ports.
- Implement real-time interrupt and data transfer. Design your own micro-computer

Comes to you complete:

- Step by step instruction manual, operators manual
- 8085A sub-routine manual, 352 pg. Cookbook.
- 334 pg. Software Des. book, 190 programs.
- Fully expandable, deluxe operating system.

Hardware includes:

- Fully assembled, tested 8085A unit.
- CPU circuitry with 44 pin connector.
- User determined BUS system.
- Wire wrap area for buffers, gates, etc.
- Two EPROM sockets.

**ETRONIX**  
14803 NE 40th, DEPT RE382  
Redmond, WA 98052

CALL 1-800-426-1044 TOLL-FREE

□ SEND FREE INTRO PLUS PARTS LIST

# SCR SUPER-BUYS

① FREE SCRAMBLER PLANS plus a brochure describing our new UHF-VHF Conversion Kit are yours just by sending us your name, address and a 20c stamp.

**FREE**

② 9-INCH BLACK AND WHITE CRT MONITOR. Ideal for microcomputer or security use. 22 transistors. Designed for excellent resolution. Frequency response - 12 MHz. Continuous DC restoration for superior contrast.

Our  
Factory  
Direct  
Price

**\$165.00**  
ea.

③ UHF-VHF CONVERSION KIT. Complete with PC board; all required components; cabinet with speaker; and comprehensive brochure incl. schematic, board layout, mounting and hook-up diagrams, parts list and assembly and set-up instructions. All parts are industrial prime quality.

Our  
Own  
Famous  
Kit

**\$119.95**  
ea.

④ NEW ZENITH ZVM-121 HIGH-LEGIBILITY CRT MONITOR. Features 12" green phosphor CRT, with 15 MHz Bandwidth, 40 or 80 character widths are operator switch-selectable. Fully compatible with 80-column Apple cards, etc.

Our  
Factory  
Direct  
Price

**\$117.95**  
ea.

⑤ MITSUMI VARACTOR-TUNER. Channels 15-82. Modified for kit use.

**\$30.00**  
ea.

Standard versions. **\$28.00** ea.

**SCR ELECTRONICS INC.**  
5303 Lincoln Ave., Cypress, CA 90630

\$10.00 MIN. ORDER HANDLING/SHIPPING \$5.00  
Pay by CHECK, M.O., VISA, M/C, C.O.D.  
UPS ANYWHERE IN CONTINENTAL U.S.  
For Free Buyers Guide Catalog Circle No. 79



# CHANEY electronics inc.

P.O. BOX 27038, DENVER, COLO. 80227

- Minimum Order \$9.00
- Please include \$1.50 for shipping (UPS)
- We accept VISA and MASTERCHARGE
- EXTRA FAST SERVICE

PHONE ORDERS: 303-781-5750

## TEACHERS AND HOBBYISTS

Chaney Electronics has been providing quality electronic kits for high schools, tech schools, universities and hobbyists for over 10 years and we hope you will join the thousands of satisfied Chaney Electronic kit builders. All of our kits contain a quality etched and drilled glass epoxy pc board, all necessary electronic parts (except as noted on a few kits) and easy to understand assembly instructions. You provide a battery for the battery operated kits and if desired you may

wish to provide a case. We recommend that you use a low wattage soldering iron and good quality rosin core solder when assembling your kits. Building our kits is both rewarding and fun because they are thoroughly tested and designed so that with proper assembly they work the first time! If you have any questions please call or write; we are here to assist you.

**TIME REACTION TESTER KIT**  
If you ever thought that your sense of timing was good here's an electronic device to prove it! A LED flashes at a precise interval and you are to push a button at the exact moment it is to light. If your timing is good the led will stay on, if not the LED continues to flash. Size of board: 1" x 2". Operates on 9V battery.  
C4516 \$3.50



**ELECTRONIC "COIN TOSSER" KIT**  
This kit features an electronic way to "toss a coin". Push the button and a speaker clicks while two readouts flash "0" and "1". Use it to electronically replace the tossing of a coin in games, sporting events, etc. Operates on 9V battery. Size of board: 1 1/2" x 3 1/4".  
C4389 \$8.95



**SUPER LED FLASHER KIT**  
One of our most popular display kits, this unit is perfect for use in robot projects. Simple to build kit features IC circuitry to alternately flash 4 LEDs: 2 red, 1 yellow and 1 green. Produces a bright and colorful display. Operates from 9V battery. Size of board: 2" x 2".  
C4407 \$4.98



**120VAC VARIABLE STROBE LIGHT KIT**  
Complete variable rate strobe light kit produces brilliant flashes of light. For parties, dances, display, discos, etc. Operates from standard 120VAC. Reliable design — thousands of these are in use throughout the world. Contains XF-1 straight xenon flashtube. Overall size of completed board: 3" L x 2" W x 3" H.  
C3071 \$7.50

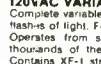

**SINGLE CHANNEL COLOR ORGAN KIT**  
Simple to build kit uses SCR to flash a Christmas tree lamp to the beat of music. Connect this up to your stereo or radio and watch the display. Operates from 120VAC and features audio input transformer for isolation and impedance matching. Size of board: 2" x 1".  
C4489 \$3.50



**GREEN NEON WINKER KIT**  
This long time favorite now has a new twist. We have designed it with green neons instead of the usual orange glow type. Features 6 green neons that randomly flash. Provides a unique display in the dark. Operates on standard 120VAC. Size of board: 4 1/2" x 2 1/2".  
C4488 \$4.75



**3VDC ELECTRONIC WARNING FLASHER KIT**  
This portable battery operated device continuously emits bursts of intense light at a fixed repetition rate. Can be seen for great distances making it a great safety device for bicycle riders, skiers, hikers, boaters, campers, etc. Transistorized kit uses high output XF-2 xenon flashtube. Operates on 3VDC (two 1.5V batteries). Size of board: 2 1/2" L x 2" W.  
C3207 \$7.95



**ELECTRONIC WHEEL OF FORTUNE KIT**  
Very popular game device! Push the start button and a bright red ball (LEDs) appear to spin around ten numbers gaining speed as you hold the button down. When you release the button the electronic ball appears to slow down and finally comes to a stop on one number. As the ball spins a small speaker emits a ticking sound in synchronization. Unit operates from 9V battery. Size of board: 2 1/2" x 2 1/2".  
C3806 \$9.99



**SOUND EFFECTS GENERATOR KIT**  
Exciting sound effects kit uses the popular T176477 chip to develop phaser, locomotive, siren, tweeting bird, organ, model T, etc. sounds. Uses dip switch for simple programming of the generator. A programming chart is included for many different sounds! The kit produces good volume and tone from 2" speaker. Operates from 9V battery. Size of board: 3 1/2" x 2".  
C4422 \$12.95



**HIGH POWER 120VAC STROBE LIGHT KIT**  
Variable rate high power strobe light similar to our standard 120VAC kit except produces flashes many times more brilliant. This kit has variable rate control and uses a XF-4 xenon horseshoe flashtube. This kit also includes a reflector for the flashtube. Operates from standard 120VAC. Overall size of board: 4 1/2" L x 3" W.  
C4182 \$15.95

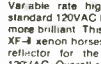

**6VDC ELECTRONIC STROBE FLASHER KIT**  
This kit is similar to our 3V Warning Flasher, however it requires 6VDC for operation and produces an even brighter flash. Although supplied with the XF-3 straight flashtube it can even power the optional horseshoe flashtube, XF-4. This unit makes a great safety device or attention getter. Can also be used with optional adapter. Size of circuit board: 3" x 1 1/2".  
C3808 \$7.95 AC ADAPTER C3804 \$1.49



**PHASOR GUN SOUND AND LIGHT KIT**  
Here's a simple kit which makes an excellent first project. Uses special IC, darlington transistor and LED to produce "outer space phasor gun" sound and flashing red light. Uses 2" speaker and small size board. Operates from 9V battery. Size of board: 1" x 1 1/2".  
C4484 \$4.00



**EXECUTIVE DECISION MAKER KIT**  
Here's another easy to build kit which is fun to use. Each time you need to make an "important" decision just operate the switch and one of two neon lamps will stay on. Features green "yes" lamp and orange "no" lamp. Operates from standard 120VAC. Size of board: 2" x 1".  
C4510 \$3.75



**3 CHANNEL COLOR ORGAN**  
Very popular 3 channel color organ causes lights of your choice to flash to the beat of music. Has 3 different filter stages for low, medium and high notes. Features level control and 3 separate AC outlets to connect Christmas lights, lamps, etc. Operates from 120VAC. Size of board: 3" x 5".  
C4530 \$8.50



**AUDIO OSCILLATOR KIT**  
Very useful for demonstration or testing speakers, earphones, etc. Kit produces pleasant tone rich in harmonics. Features output transformer for coupling to speaker of your choice. Two transistor circuit is simple to construct. Operates from 9V battery. Requires speaker. Size of board: 2" x 1".  
C4511 \$3.00



**STROBOSCOPE KIT**  
Reliable IC design kit for use in physics experiments, troubleshooting or demonstrating optical phenomena. Optically stops motion of gears, wheels, pulleys, flywheels, etc. The stroboscope operates from standard 120VAC and features bright xenon flash tube and IC design. Continuously variable flash rate from 100-5000 RPM. Size of board: 3 1/2" x 4 1/2".  
C-070 \$29.95

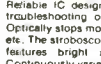

**METRONOME WITH SOUND AND LIGHT**  
One of our most popular kits now has a new feature. Not only does it produce beats in precise time but also it flashes a red LED in time. Features variable control and small speaker. This kit is perfect for music practice and is easy to build. Operates from 9V battery. Size of board: 1" x 2".  
C4533 \$3.50

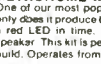

**LIGHT SENSITIVE SOUND GENERATOR KIT**  
Simple to build kit creates a tone which varies depending on amount of light. Uses CDS cell and IC circuitry to provide this unusual effect. In total darkness the unit is silent, as light increases the unit goes from a clicking sound to a loud tone. Uses 2" speaker and operates from 9V battery.  
C4164 \$4.95

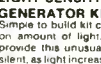

**DIGITAL POWER SUPPLY KIT**  
Regulated power supply, perfect for TTL or CMOS circuits. Regulated output voltage is 5VDC. Maximum output current is 500 amp. Features fused input, neon indicator light and IC regulator. Kit uses heavy duty transformer for trouble free performance. Operates from standard 120VAC. Size of board: 2" x 4".  
C4430 \$6.50



**46WS PHOTO STROBE FLASH KIT**  
Here's your chance to make a quality high power strobe flash for your camera. Can also be used as the master strobe with any of the slave kits. Features quality long life straight flashtube, heavy duty photoflash capacitor, neon ready light, transistorized inverter circuitry and shutter cord for connection to camera. Operates from 4.5VDC to 6VDC. Size of board: 3" x 2 1/2".  
C4512 \$9.95



**100WS SLAVE STROBE AC KIT**  
This kit is similar in operation to the DC slave strobe, however, this unit is more than double the light power output. Features heavy duty horseshoe flashtube, two heavy duty photoflash caps, neon ready light, solar cell sensor, and manual test button. Operates from 120VAC. Size of board: 3 1/2" x 4". NOTE: This kit is NOT for beginners since due to the power of the flash, hazardous potentials are present.  
C4491 \$34.95



**AC TESTER KIT**  
This kit is perfect for testing AC outlets or determining which breaker operates a particular outlet! There's no need to be in the same room as the unit emits a penetrating tone as long as AC is present. Features green "ON" light and piezoelectric tone alert in a compact unit. Size of board: 2" x 1 1/2".  
C4485 \$4.50

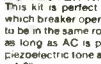

**DUAL LAMP FLASHER KIT**  
Ultra miniature lamp flasher kit uses tiny grain of wheat bulbs and IC to flash 2 bulbs at the same time or alternating. Unit produces bright flashes and can be used on model planes, boats, attention getters, warning lights, etc. Operates from 9V battery. Size of board: 1 1/2" x 8".  
C4487 \$2.50



**LED FLASHER KIT**  
Easy to build functional kit uses the amazing 555 timer IC to alternately flash a red and green led. The kit makes a great attention getter and can be used in robots, warning lights, outer space models, convention badges, etc. Operates from 5 to 9VDC. Size of board: 1 1/2" x 1 1/2".  
C3287 \$2.49

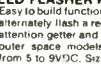

**SIGNAL INJECTOR KIT**  
Signal injectors are useful for troubleshooting all types of radios, amplifiers, tuners, etc. This simple to build transistorized kit produces an output signal rich in harmonics. Every tool kit and test bench should have one of these. Small size allows use of compact cases if desired. Operates from 3VDC. Size of board: 5" x 1 1/2".  
C4513 \$3.00



**TRI STATE LED FLASHER KIT**  
Simple to build kit which flashes a tri-state led. The kit has a trimmer control which can be rotated to provide continuous green, alternating red/green, or continuous red. Kit features IC circuitry and jumbo tri-state LED which, even though it's only a two lead device, can flash red or green. Operates from 9V battery. Size of board: 1 1/4" x 1 1/4".  
C4069 \$2.95



**46WS SLAVE STROBE DC KIT**  
Sensitive slave unit flashes in synchronization with your master strobe. Perfect way to obtain more light for portrait pictures. Comparable units sell for many times this low kit price. Features quality long life straight flashtube, neon ready light, solar cell sensor, heavy duty photoflash capacitor and transistorized inverter circuit. Operates from 4.5VDC to 6VDC. Size of board: 3 1/2" x 2 1/2".  
C4490 \$16.95



**AC FAILURE ALARM KIT**  
Have you ever been late because the AC went off and your clock radio didn't work, well that need not happen again! Simply plug this unit into the wall outlet and if the AC goes off the unit emits a tone. Features green ready light and piezoelectric tone device. Operates on 9V battery. Size of board: 2 1/2" x 2 1/2".  
C4483 \$4.75

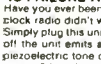

**FASCINATION STAR KIT**  
Produces an "Expanding visual effect using 25 LEDs and IC circuitry. The center LED lights first then the next group of LEDs light and then another set lights until the outer edge of the star lights up. The process then reverses itself. Great attention getter for game rooms, discos, etc. Operates from 9V battery.  
C4432 \$10.95

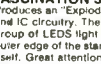

**PHOTO SLAVE TRIGGER KIT**  
Probably the most sensitive trigger kit on the market. Not affected by ambient light. Much superior than LASCR types. This kit can operate from bounce or indirect flash. Simply connect shutter cord (included) to the strobe that will be used as the slave. When the master strobe is fired the slave strobe will also flash. Size of board: 1 1/2" x 1 1/2".  
C4450 \$6.00

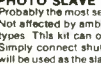

**10 WATT SIREN KIT**  
This kit is perfect for use in burglar alarms, panic buttons, attention getters, etc. Kit produces a loud alternating tone output. Uses two IC's and a power transistor to provide reliable performance. Features variable sound control and 6 to 12VDC operation. Requires 8 ohm speaker. Size of board: 3 1/2" x 1 1/2".  
C4068 \$5.00



**SEQUENTIAL LED FLASHER KIT**  
This kit combines CMOS IC circuitry and 10 jumbo red LEDs to produce a unique visual display. LEDs continuously light sequentially from right to left. Easy to build kit makes a great conversation piece and attention getter. Operates from 9V battery. Size of board: 5 1/2" x 1 1/2".  
C4431 \$6.75



## NEW KITS FROM CHANEY ELECTRONICS

CIRCLE 12 ON FREE INFORMATION CARD

# UNBELIEVABLE!

## HITACHI 30 MHZ DUAL TRACE OSCILLOSCOPE

AT THE LOWEST PRICES  
YOU CAN FIND!



Model V302B

List 995.00

Sale 815.00

See below for freight allowance

- Signal delay line
- 5" CRT
- 12 ns rise time
- TV sync separator
- 1 mV/division sensitivity (max.)
- Vertical magnifier (x5)
- Sweep magnifier (x10)
- X-Y operation
- Front panel trace rotation
- CH1, CH2, Add, Diff. display modes
- "Z" axis (intensity) modulation
- Two years parts and labor warranty
- Two -X10 probes included!

## 15 MHz dual trace AN EVEN GREATER VALUE!



Model V152B

List 735.00

Sale 599.95

- 5" CRT
- 24 ns rise time
- TV Sync separator
- 1 mV/div sensitivity to 5 MHz
- Vertical and sweep magnifiers
- Front panel trace rotation
- Five modes of vertical deflection
- Two years parts and labor warranty
- Two -X10 probes included

### ALL OTHER HITACHI SCOPES ON SALE

50 MHz, 100 MHz, 35 MHz, 20 MHz. Call for details

Also available:

Leader Instruments, Beckman, Univolt, Fluke, and other quality test equipment.

To order call toll free: (800) 423-5336

In Calif. (800) 423-5336

Local, Alaska, Hawaii (213) 701-5848

A DIV. OF ALLIANCE RESEARCH CORP

# ORA Electronics

18215 Parthenia St. Northridge, CA 91325

**TERMS:** All items are subject to prior sale. Limited quantity on hand. Payment: Visa, Mastercard accepted. Exact freight and insurance will be added. C.O.D. orders accepted from recognized businesses. Prepaid orders: Payment must be made with U.S. currency. Orders paid with personal or company check will be held for check to clear. Free freight policy: Prepaid orders paid by cashiers check will be shipped UPS freight free to any point in the continental U.S. (Alaska, Hawaii, Canada excluded.)

## BUY of the YEAR!!!

### Parallel, TTL Input WORD PROCESSOR I/O "Selectric"® TYPEWRITER/PRINTER

The manufacturer put 'em into storage to depreciate 'em... Now they're **FINALLY AVAILABLE!** Removed from working systems, these fantastic machines have built-in driver and decoder circuitry and take TTL level, 6-bit character, plus 4-bit function input signals... Easily driven by most any micro. Use as a typewriter (with minor "repeat" circuitry) or as a KSR I/O printer or both. Requires 115, 60Hz for typewriter motor, 5 VDC for TTL and 24 VDC for solenoids. "Table top" style case. Each "Selectric" I/O machine is complete and in operational condition! Includes schematics, data, case, platen and ribbon. (Type element not included).



New Type Element ..... \$21.00ea. I/O Selectric ..... **\$399.00ea.**  
Add \$20 for Packaging and Handling - Pay Shipping on Delivery

### WORD PROCESSOR CPU ASSEMBLY

Linked to and used with the above machine, this unit completes a system which originally sold for over \$3000.00 each! Features include: standard cassette deck, auto centering, auto repeat, auto underline, suppressed notations, record/playback, auto merge, editing, margin adjusting and much, much more. Parts include tape or "mag" card deck, cabinet, fans, power supply, mother board, connectors, cables, LEDs and more. Worth much more than our price for the parts alone. Includes schematics and data. Tested and functional.



Only **\$199.00ea.**

Add \$20 for Pkg. and Handling - Pay Shipping on Delivery

**Additional Cassette or 'Mag' Card Ass'ly**  
Add-on package includes everything you need to add on the second deck. Easy to retrofit.

Only **\$199.00ea.**

**New, Unused Cassettes or 'Mag' Cards**  
For above Word Processor.

Tape Cassette ..... **\$7.99ea., 10/169.00**  
'Mag' Card ..... **\$2.49ea., 10/119.00**

We Offer New and Used FLOPPY DRIVES, DISK DRIVES, PRINTERS, & MORE at BARGAIN PRICES!!! Ask for our Latest Flyer Listing NOW!

## COMPUTERS, PERIPHERALS, UNLIMITED!

WAREHOUSE:  
18 Granite St., Haverhill, Mass. 01830

MAIL ORDER:  
Box 204, Newton, N.H. 03858

TELEPHONE ORDERS:

**617/372-8637**

Sorry, No Collect Calls

MasterCharge & VISA Accepted



CIRCLE 28 ON FREE INFORMATION CARD



## Components Express, Inc.

"Have you kissed your computer lately?"

1380 E. Edinger, Unit CC Santa Ana, CA 92705 (714) 558-3972

### BROAD BAND MICROWAVE RECEIVER SYSTEM 1.8GHZ to 2.4 GHZ

only  
**\$295.**

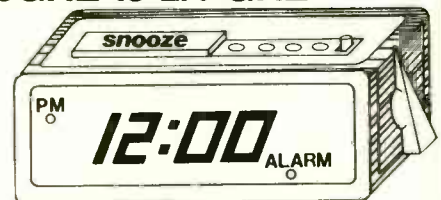

With built-in-converter to channel  
2, 3, or 4 of any standard TV set.

- 24" Dish
- Feed-Horn Receiver
- Mounting Bracket
- Mounting Clamp
- Instructions
- 300 Ohm to 75 Ohm Adapter
- 750 Ohm to 300 Ohm Adapter
- 60 Feet Coax Cable with Connectors
- 3 Feet Coax Cable with Connectors

RANGE: Line of sight to 250 miles.

SCOPE: Will receive within the frequency band from satellites, primary microwave stations, and repeater microwave booster stations.

CONTENTS: Completely packaged in 19"x19"x4 1/2" corrugated carton complete with list.

WARRANTY:

180 days for all factory defects and electronic failures for normal usage and handling. Defective sub-assemblies will be replaced with new or re-manufactured sub assembly on a 48 hour exchange guarantee.

This system is not a kit and requires no additional devices or equipment other than a TV set to place in operation.

Dealer inquiries invited.



# FUJITECH AUDIO KITS

## LATEST AUDIO TECHNOLOGY FROM JAPAN

### Model A501 Power Amp

- Pure Class A 25W + 25W
- Switchable to Class AB 100W + 100W
- Switchable to Bridge Class A 100W mono
- Switchable to Bridge Class AB 300W mono
- Frequency Response 5-200KHz (-1dB)
- Signal-to-Noise Ratio 120dB
- Non-magnetic Chassis
- "Out-board" comprehensive protection circuitry
- DC circuitry with limited use of NFB
- High Efficiency Fluid Convection Cooling
- THD under 0.007%

KIT ONLY  
\$299.00

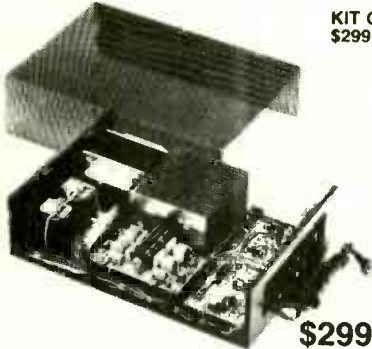

\$299.00

### Model A502 DC Stereo Control Center

- Direct DC coupling from Input to Output
- DC servo circuitry
- Cascade FET Input in all stages
- Separate Moving Coil RIAA amplifier
- Distortion below 0.005% (3V)
- Max Output 15V
- Frequency Response 20Hz-20KHz ±0.2 dB
- Maximum Phono Input
  - MC = 16mv RMS (1KHz)
  - MM = 270mv RMS (1KHz)
- Built-in Headphone amplifier
- Relay Output Muting

KIT ONLY  
\$349.00



\$349.00

### Model A1033 Integrated Tube Amplifier

- Latest Japanese Design
- Distortionless Output Transformer using special winding techniques
- Most circuitry on PCB for easy assembly and humfree performance
- Output 30W x 2 Ultra Linear (Switchable to Triode)
- 15W x 2 Triode Output (near class A performance)
- THD under 0.4%
- Frequency Response 30~30,000 Hz (-1dB)
- Separate Pre-Out and Main-In

KIT ONLY  
\$499.00

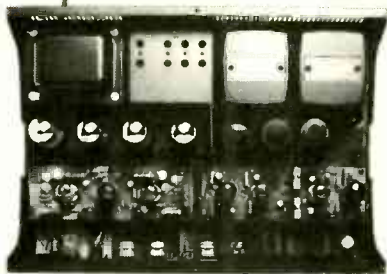

\$499.00

Send \$5.00 for each assembly manual, refundable with order.

Monarchy Engineering, Inc.  
380 Swift Avenue, Unit 21  
South San Francisco, CA 94080  
Visa or Mastercharge acceptable.

# INTRODUCING OUR NEW STVA 14 ELEMENT CORNER REFLECTOR YAGI ANTENNA

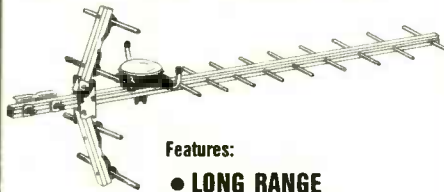

### Features:

- LONG RANGE
- 14.5 dB GAIN
- SELECTABLE 75 or 300 Ohm IMPEDANCE
- NARROW PATTERN for adjacent interference rejection
- ANODIZED FINISH
- STURDY CONSTRUCTION

STVA-3 14.5 dB Selectable Corner Yagi  
Cut for Channels 60 thru 68. . . . \$16.95

STVA-4 14.5 dB Selectable Corner Yagi  
Cut for Channels 44 thru 52. . . . \$16.95

## VTR ACCESSORIES

### SIMPLE SIMON VIDEO STABILIZER



Model  
VS-125

Simple Simon Video Stabilizer, Model VS-125, eliminates the vertical roll and jitter from "copy guard" video tapes when playing through large screen projectors or on another VTR. Simple to use, just adjust the lock control for a stable picture. Once the control is set, the tape will play all the way through without further adjustments. Includes 12V power supply.

VS-125 Video Stabilizer wired . . . . . \$54.95

### SIMPLE SIMON VIDEO SWITCHING BOX



Model VSB-300

The Affordable Video Control Center!

Excellent in isolation and no loss routing system. Simple Simons VSB-300 Video Switching Box enables you to bring a variety of video components together for easy viewing/dubbing. Also you gain the ability to record one channel while viewing another. Unit includes two F-type quick connector ended cables.

VSB-300 Video Switching Box wired . . . . \$19.95

## SIMPLE SIMON EL 7 + 11 SWD

### MITSUMI VARACTOR UHF TUNER Model UES-A56F \$34.95

Freq. Range UHF470 - 889MHz  
Antenna Input 75 ohms  
Channels 14-83 Output Channel 3

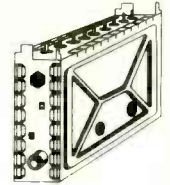

| KIT NO  | PART NO | DESCRIPTION   | PRICE   |
|---|---------|---|---------|
| 1   | VT1-SW  | Varactor UHF Tuner, Model UES-A56F  | \$34.95 |
| 2   | CB1-SW  | Printed Circuit Board, Pre-Drilled  | 18.95   |
| 3   | TP7-SW  | P.C.B. Potentiometers, 1-20K, 1-1K, and 5-10K ohms, 7-pieces  | 5.95    |
| 4   | FR35-SW | Resistor Kit, ¼ Watt, 5% Carbon Film, 32-pieces   | 4.95    |
| 5   | PT1-SW  | Power Transformer, PRI-117VAC, SEC-24VAC, 250ma   | 6.95    |
| 6   | PP2-SW  | Panel Mount Potentiometers and Knobs, 1-1KBT and 1-5KAT w/Switch  | 5.95    |
| 7   | SS14-SW | IC's 7-pcs, Diodes 4-pcs, Regulators 2-pcs Heat Sink 1-piece  | 29.95   |
| 8   | CE9-SW  | Electrolytic Capacitor Kit, 9-pieces  | 5.95    |
| 9   | CC33-SW | Ceramic Disk Capacitor Kit, 50 W.V., 33-pieces  | 7.95    |
| 10  | CT-SW   | Variable Ceramic Trimmer Capacitor Kit, 5-65pfd, 6-pieces   | 5.95    |
| 11  | L4-SW   | Coil Kit, 18mhs 2-pieces, 22µhs 1-piece (prewound inductors) and 1 T37-12 Ferrite Torroid Core with 3 ft. of #26 wire           | 5.00    |
| 12  | ICS-SW  | I.C. Sockets, Tin Inlay, 8-pin 5-pieces and 14-pin 2-pieces   | 1.95    |
| 13  | SR-SW   | Speaker, 4x6" Oval and Prepunched Wood Enclosure  | 14.95   |
| 14  | MISC-SW | Misc. Parts Kit Includes Hardware, [6/32, 8/32 Nuts, 6 Bolts], Hookup Wire, Ant. Terms, OPDT Ant. Switch, Fuse, Fuseholder, etc | 9.95    |
| When Ordering All Items. (1 thru 14), Total Price |         |   | 139.95  |

## UHF ANTENNAS and ACCESSORIES

### ZYZZX

### VHF-UHF WIDEBAND ANTENNA AMPLIFIER

MODEL ALL-1  
50 MHz — 900 MHz  
12 dB GAIN ± 0.5dB

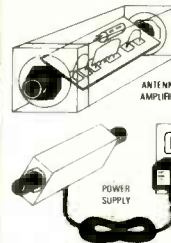

A Revolutionary New One Stage HYBRID IC Broadband Amplifier

This unit is not available anywhere else in the world. One unit serves many purposes and is available in Kit or Assembled form. Ideal for outdoor or indoor use. Input-output impedance is 75 ohms. Amplifier includes separate co-ax feed power supply. Easily assembled in 25 minutes. No coils, capacitors etc. to tune or adjust.

ALL-1 Complete Kit with power supply . . . . . \$24.95

ALL-1 Wired and Tested with power supply . . . . . \$34.95

### Our New STVA 14.5 dB GAIN, 14 ELEMENT CORNER REFLECTOR YAGI ANTENNA



STVA-3 Yagi Antenna, 14.5 dB, 75 ohm, Chan 60-68 . . . \$16.95  
STVA-4 Yagi Antenna, 14.5 dB, 75 ohm, Chan 44-52 . . . \$16.95

STVA-1 Yagi Antenna, 11.5 dB, 75 ohm, Chan 42-54 . . . \$9.95  
STVA-2 Yagi Antenna, 11.5 dB, 75 ohm, Chan 20-28 . . . \$9.95

|         |   |                       |
|---------|---|-----------------------|
| RG-59/U | 75 ohm Low Loss Coax Cable                          | . . . . . \$ .12 p/ft |
| F-59    | Coaxial Connectors, ea                              | . . . . . .39         |
| MT-1    | Special UHF 75-300 ohm Matching Transformer, ea     | . . . . . 1.45        |
| ALL-1   | HYBRID IC Wideband VHF-UHF-FM Antenna Amplifier Kit | . . . . . 24.95       |
| ALL-1   | HYBRID IC Wideband VHF-UHF-FM Ant. Amp. Assembled   | . . . . . 34.95       |

Available by Mail Order Only — Send Check or Money Order To:

## SIMPLE SIMON ELECTRONIC KITS, Inc.

Calif. Orders:  
3871 S. Valley View, Suite 12  
Las Vegas, Nevada 89103  
Tel: (702) 322-5273

All Other Orders:  
11850 S. Hawthorne, Blvd.  
Hawthorne, Calif. 90250  
Tel: (213) 675-3347

Minimum Order: \$16.95. Add 10% Shipping and Handling on orders under \$40.00. For orders over \$40.00, add 5%. Minimum Shipping and Handling \$2.00. Catalog \$1.00. — VISA and Mastercard Acceptable —

Parts at  
**PRICES!**

**CERAMIC RECORD CHANGER**



- \* FULL SIZE CHANGER
- \* B.S.R. MODEL C198
- \* CERAMIC CARTRIDGE
- \* PLAYS 33, 45 & 78 RPM RECORDS....
- \* CUE/PAUSE LEVER
- \* ADJ. TRACKING FORCE

RECORD CHANGER DOES NOT INCLUDE BASE OR A.C. CORD..

**\$25.00 EACH 4 for \$90.00**

**4PDT RELAY**

- 14 pin style
  - 3 amp contacts
  - 24 volt d.c. or 120 volt a.c. Coil
  - Used but fully tested
- \$1.70 EACH**  
specify coil voltage  
LARGE QUANTITIES AVAILABLE  
SOCKETS FOR RELAY 50¢ each



**JOYSTICK**

- PRECISION DEVICE...  
CONTAINS 4 50K CENTER TAPPED ALPS POTS.....
- 
- \$4.75 each**

**MINI SIZE BUZZERS**

- 1/2 to 3 volts 75¢ ea  
WITH WIRE LEADS
- 1/2 to 3 volts 75¢ ea  
WITH PIN TERMINALS
- 3 to 7 volts  
WITH PIN TERMINALS  
75¢ each

**MITSUMI MODEL UES-A55F VARACTOR UHF TUNER**

- FREQ. RANGE  
470 - 889 MHz  
ANTENNA INPUT  
300 OHMS
- 
- \$25.00 each**  
10 for \$220.00

**RFI/EMI FILTER**

- FOR NOISE SUPPRESSION  
C/D# APF50M  
RATED: 5 AMPS  
250 VAC
- 
- \$3.50 each**

**SPECIAL**

- 1000 MFD 25 VOLT  
2 FOR \$1.00

**FLAT LEVER MINI-TOGGLE S.PDT (ON-ON)**

- 5 AMP @ 120 VAC  
CCK # 7105  
**\$1.00 EACH**  
10 for \$8.50  
100 for \$75.00
- 

SEND FOR NEW 1982  
Free! 40 PAGE CATALOG Free!

**COMPUTER GRADE CAPACITOR**

- 1700 mfd. 150VDC \$2.00  
2 1/2" DIA X 4 3/4" HIGH
- 3,600 mfd. 40VDC \$1.00  
1 3/8" DIA. X 3" HI
- 6,400 mfd. 60VDC \$2.50  
1 3/8" DIA X 4 1/4"
- 12,000 mfd. 40 VDC \$3.00  
2" DIA X 4 1/4" HIGH
- 18,000 mfd. 75 VDC \$4.00  
2 1/2" DIA X 4 1/2" HIGH
- 20,000 mfd. 25VDC \$2.00  
2 1/4" DIA. X 2 3/4" HIGH
- 22,000 mfd. 15VDC \$2.00  
2 1/4" DIA X 2 1/2" HIGH
- 22,000 mfd. 40VDC \$3.00  
2 1/4" DIA. X 6" HIGH
- 25,000 mfd. 75 VDC \$4.50  
3" DIA X 4 3/8" HIGH
- 45,000 mfd. 25 VDC \$3.50  
2 1/4" DIA. X 4" HIGH
- 72,000 mfd. 15 VDC \$3.50  
2 1/4" DIA. X 4" HIGH
- CLAMPS TO FIT CAPACITORS 50¢ ea.

**L.E.D.'s STANDARD JUMBO DIFFUSED**

- RED 10 FOR \$1.50  
GREEN 10 FOR \$2.00  
YELLOW 10 FOR \$2.00
- FLASHER LED**  
5 VOLT OPERATION  
JUMBO SIZE  
2 FOR \$1.70
- BI POLAR LED**  
2 FOR \$1.70
- SUB MINI LED**  
.079" X .098"  
20 mA at 1.75v  
10 FOR \$1.00  
200 FOR \$18.00
- QUANTITY PRICES AVAILABLE

**CANNON XLRA-3-13 CONNECTOR**

- 3 PRONG CHASSIS MOUNT CONNECTOR  
**\$2.00 EACH**  
10 for \$19.00
- 

**SUPER SMALL PHOTO-FLASH**

- 170 MFD 330 VOLT  
1 1/4" X 7/8"  
2 for \$1.50  
10 for \$7.00
- 

**BLACK LIGHT (ULTRAVIOLET)**

- G.E. # F6T5BL \$2.50 each
- 

**750 MFD 330 V PHOTO FLASH**

- 2" HIGH X 1 1/4" DIA  
\$1.25 EACH  
10 FOR \$11.00
- 

**TRANSFORMERS**

- 120 volt primaries
- 6 VOLTS at 150 mA \$1.25  
12 V.C.T. at 500 mA \$2.50  
16.5 V. at 3 AMPS \$6.50  
18 VOLTS at 1 AMP \$4.50  
25.2 VCT at 2.8 AMP \$5.50
- 

**BUZZER SPECIAL!**

- 50¢ each  
10 for \$4.00  
100 for \$35.00
- 

**SPECIAL MRF 901**

- MICROWAVE TRANSISTOR  
**\$2.50 EA.**
- 

**ALL ELECTRONICS CORP.**

905 S. Vermont Ave.  
P.O. BOX 20406  
Los Angeles, Calif. 90006  
(213) 380-8000

Mon. - Fri. Saturday  
9 AM - 5 PM 10 AM - 3 PM

TERMS  
• Quantities Limited  
• Min. Order \$10.00  
• Add \$ 2.50 Shipping USA  
• Calif. Res. Add 6%  
• Prompt Shipping

**ADVERTISING INDEX**

RADIO-ELECTRONICS does not assume any responsibility for errors that may appear in the index below.

**Free Information Number Page**

|       |  |               |
|-------|--|---------------|
| 59    | AMC Sales                                  | 84            |
| 53    | A.P. Products                              | 22            |
| 71    | Abex                                       | 73            |
| 9     | Active Electronics                         | 91            |
| -     | Advance Electronics                        | 5.32-33.34.79 |
| 77,78 | Advanced Analog Systems, Inc.              | 73            |
| 3     | Advanced Computers                         | 100-101       |
| 20    | All Electronics                            | 118           |
| 45,73 | Alpha Byte Stores                          | 1.73          |
| 15    | Altex Electronics                          | 110           |
| 38    | American Antenna                           | Cover 4       |
| 10    | Ancrona Electronics                        | 113           |
| 19    | Arizona Electronics                        | 106           |
| 41    | B&K Precision Dynascan Corp.               | 17            |
| -     | Karel Barta                                | 92            |
| 46    | Beckman Instruments Electro-Products Group | 13            |
| -     | Bullet Electronics                         | 102           |
| -     | CIE, Cleveland Institute of Electronics    | 18-21         |
| 55    | Cambridge Learning, Inc.                   | 35            |
| 58    | Castle Marketing                           | 16            |
| 12    | Chaney Electronics                         | 115           |
| -     | Clear-Vue Electronics                      | 93            |
| 64    | Command Productions                        | 89            |
| 48    | Communications Electronics                 | 2             |
| -     | Components Express                         | 116           |
| 28    | Computer Peripherals, Unlimited            | 116           |
| 44    | Computer Shopping Center                   | 71            |
| -     | Cook's Institute of Engineering            | 92            |
| 16    | Concord Electronics                        | 112           |
| 60    | Jan Crystals                               | 86            |
| -     | DRI Industries, Inc.                       | 88            |
| -     | Dage Scientific                            | 92            |
| -     | Data Services Co.                          | 90            |
| 8     | Digi Key Corp.                             | 111           |
| 74    | Digi Max Instruments Corp.                 | 73            |
| 62,63 | Drake Company                              | 88,89         |
| 52    | EG&G Reticon                               | 75            |
| -     | Edu Clac                                   | 81            |
| 70    | Electra Bearcat                            | 82            |
| 31    | Electronic Specialists, Inc.               | 98            |
| -24   | Etco Electronics                           | 96,98         |
| 33    | Etronix                                    | 114           |
| 43    | Fluke Mfg. Co., Inc.                       | 15            |
| -     | Fordham Radio                              | 36-37,112     |
| 2     | Formula International                      | 94-95         |
| 27    | Fuji Svea                                  | 99            |
| 29    | Guico International, Inc.                  | 114           |
| 65    | Gladstone Electronics                      | 85            |
| 47    | Global Specialties Corp.                   | 69            |
| 21    | Global TV Electronics                      | 90            |
| -     | Godbout Electronics                        | 93            |
| 37    | Grantham College of Engineering            | 83            |
| 54    | Grove Enterprises                          | 92            |
| 49    | Hal-Tronix                                 | 102           |
| 34    | Hameg, Inc.                                | 26            |
| 72    | Heath                                      | 14,Cover 3    |
| 36    | Hitech Electronics                         | 102           |
| 61    | Huntron Instruments                        | 73            |
| 11    | Information Unlimited                      | 96            |
| 4     | International Crystal Mfg. Co., Inc.       | 83            |
| 79    | JDR, Microdevices                          | 108-109       |
| 50    | Jameco Electronics                         | 104-105       |
| 25    | Javanco                                    | 99            |
| -     | Keithley Instruments                       | 77            |
| -     | H.J. Knapp                                 | 98            |
| -     | Komac                                      | 99            |
| -     | LT Sound                                   | 93            |
| -     | McGee's Radio                              | 93            |
| -     | Microtenna Associates                      | 90,92         |
| 14    | Mikos                                      | 110           |
| 30    | Monarchy Engineering, Inc.                 | 117           |
| -     | Mountain West                              | 98            |
| -     | NRI Schools                                | 8-11          |
| -     | NTS Schools                                | 28-31         |
| -     | Nabih's, Inc.                              | 86            |
| -     | Netronics                                  | 83            |
| 42    | O.K. Machine & Tool Corp.                  | 38            |
| 17    | Ora Electronics                            | 116           |
| 56    | Pac-tec Corp.                              | 88            |
| 80,81 | Paia Electronics                           | 16,26         |
| 67    | Panavise                                   | 81            |
| 32    | Poly Paks                                  | 114           |
| -     | RCA  | 7.84-85       |
| 5     | Radio Shack                                | 97            |
| 6     | Ramsey Electronics                         | 103           |
| 35    | SCR Electronics                            | 114           |
| -     | SMP, Inc.                                  | 73            |
| 76    | Sabadia Exports Corp.                      | 92            |

|       |                          |         |
|-------|--------------------------|---------|
| 69    | H.W. Sams                | 86      |
| -     | Satellite TV, Inc.       | 90      |
| 51    | Shure Brothers, Inc.     | 72      |
| -     | Simple Simon Electronics | 117     |
| -     | Sinewave Mktg. Corp.     | 114     |
| -     | Sinclair Research        | 24-25   |
| 68    | N.A. Soar                | 89      |
| 13    | Solid State Sales        | 106     |
| -     | Sound Video Research     | 96      |
| -     | Spacecoast Research      | 90      |
| -     | Sunshine Express         | 27      |
| 22    | Suntronics Co., Inc.     | 102     |
| 7     | Surplus Electronics      | 107     |
| 66    | Telematic                | 87      |
| -     | Tennessee Electronics    | 90      |
| 39,40 | Triplet                  | Cover 2 |
| 23    | Tri-Tek                  | 96      |
| 75    | Ungar                    | 73      |
| 57    | Vector Electronics Co.   | 16      |
| -     | Video Playground         | 87      |
| 26    | Westland Electronics     | 96      |
| -     | Wersi                    | 92      |

**Heart disease and stroke will cause half of all deaths this year.**



**American Heart Association**

WE'RE FIGHTING FOR YOUR LIFE

**MOVING?**

Don't miss a single copy of **Radio-Electronics**. Give us:

ATTACH LABEL HERE

Six weeks' notice

Your old address and zip code

Your new address and zip code

name

(please print)

address

city

state

zip code

Mail to: Radio-Electronics  
SUBSCRIPTION DEPT., P.O. BOX 2520,  
BOULDER, COLO. 80322

RADIO-ELECTRONICS



# WHAT'S THE KEY TO BUYING A COMPUTER?

Look beyond the computer. Look at how the total system—hardware, software, support, service—meets your needs, today and tomorrow. That's the key. When you choose a computer source, you choose a long term partner who must stand by you with total support. And no one stands by you like Heath/Zenith.

## Software

Including word processing, business applications, versatile utility programs, and the Heath Users' Group library of over 500 low-cost programs for home, work or play.

And a choice of three operating systems, including CP/M by Digital Research for compatibility with thousands of popular CP/M programs.

## Languages

For your own custom programs, Microsoft languages are available in BASIC (compiler and interpreter), FORTRAN and COBOL.

## Self-Study Courses

Learn at your own pace with *Programming Courses* that teach you to write and run your own programs in Assembly, BASIC, Pascal or COBOL.

For the business person, *Computer Concepts for Small Business* helps you evaluate the ways a computer can benefit your business. And for the novice, *Personal Computing* is a complete introduction to computer fundamentals and BASIC Programming.

## Support

Before and after the sale we work with you to configure the system that serves you best. We help you get your system up and running smoothly. Assistance is always just a phone call away.

## Service

Friendly, experienced technicians are available, either over the phone or at any of the 56 Heathkit Electronic Centers nationwide.

## Visit your Heathkit Electronic Center\*

See your telephone white pages for the store nearest you. And stop in today for a demonstration of how Heath/Zenith Computer Systems can serve you. If you can't get to a store, send \$1.00 for the latest Heathkit Catalog and the new Zenith Data Systems Catalog of assembled commercial computers. Write to Heath Co., Dept. 020-874, Benton Harbor, MI 49022.

Pick a strong partner.  
**Heath/Zenith & You.**

## HEATH/ZENITH

Your strong partner

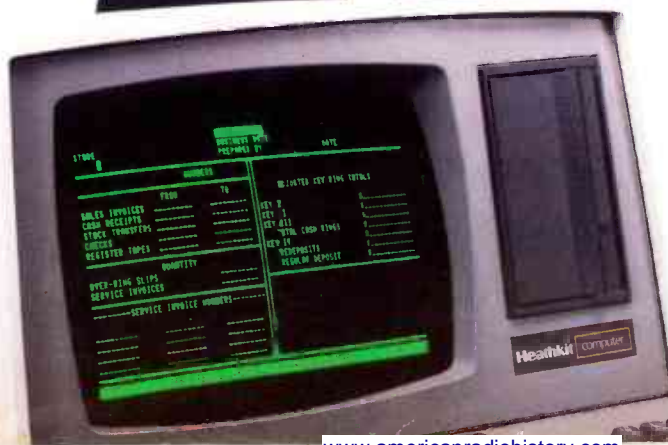

\*Units of Veritechnology Electronics Corporation in the U.S.

Specifications subject to change without notice.

# APRIL 24<sup>TH</sup> 1981 A PROFESSIONAL INDEPENDENT TESTING LABORATORY RATED THE K40 THE HIGHEST PERFORMANCE RADAR DETECTOR IN THE WORLD!

**1** ESCORT, WHISTLER, FOX, JR. MICROWAVE, SUPER SNOOPER AND FUZZBUSTER ALL COMPETED IN THE CONTEST.

**2** THE BRAND NEW K40 RADAR DETECTOR USING A UNIQUE WAVE GUIDE COUPLED DIE CAST ANTENNA DETECTED X BAND RADAR AN AVERAGE OF 54% FURTHER THAN ALL OTHER DETECTORS AND 67% FURTHER ON THE K BAND FREQUENCY.

**3** HERE'S THE TEST THAT PROVED IT!

| TEST RESULTS      |                                       |
|-------------------|---------------------------------------|
| MANUFACTURER      | COMBINED X & K-BAND DISTANCE FROM GUN |
| K40               | 2.96 MILES                            |
| ESCORT            | 2.30 MILES                            |
| GUL               | 2.28 MILES                            |
| BEL               | 2.52 MILES                            |
| RADAR INTERCEPTOR | 1.92 MILES                            |
| WHISTLER D4000    | 1.43 MILES                            |
| AUTOTRONICS       | 1.30 MILES                            |
| FOX               | 1.25 MILES                            |

THEIR TEST NOT OURS



**OUTPERFORMS ESCORT**  
THE K40 OUTPERFORMED THE ESCORT 17% ON K-BAND AND 34% ON X-BAND. THE K40 AVERAGED 28% MORE DISTANCE THAN ESCORT AND 60% FURTHER THAN ALL OTHERS COMBINED.

\*April 24, 1981 TKI International

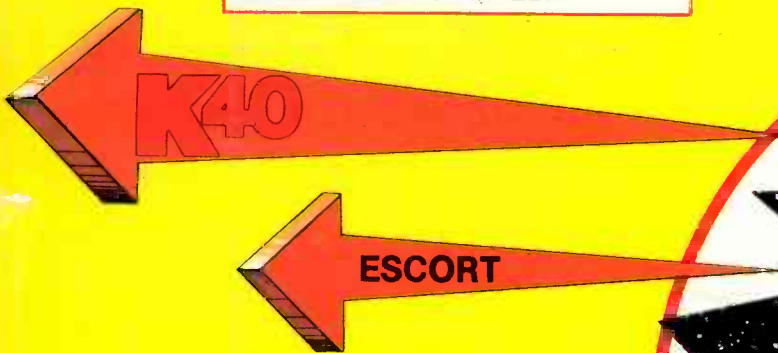

**\$380<sup>00</sup>**  
IT COSTS MORE BECAUSE IT'S MADE BETTER!

**DOUBLE GUARANTEE**  
**GUARANTEE I:** We're so convinced our K40 Radar Detector will intercept Police Radar Better Than Any Commercial Radar Device, we'll allow you to test our K40 in your car for 7 days... if not satisfied with its performance, return to your K40 dealer who installed it for a prompt and full refund.  
**GUARANTEE II:** Unconditionally guaranteed for 12 months. Guaranteed against cracking, chipping or rusting. Guaranteed against mechanical failure. Guaranteed against electrical failure. No exclusions. No gimmicks. For a FULL 12 MONTHS.

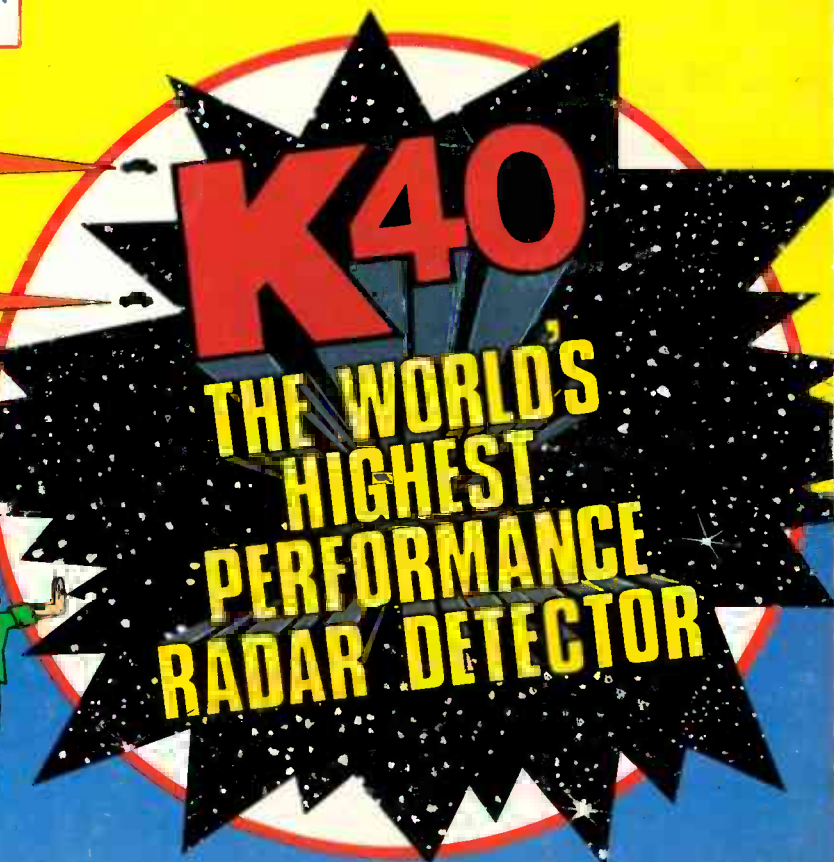

CALL 800-323-5608 (ILLINOIS-800-942-8175) FOR THE DEALER NEAREST YOU. **AMERICAN ANTENNA**

... Sold exclusively by **\$500** American **CB** Dealers throughout the U.S. & Canada.

CIRCLE 38 ON FREE INFORMATION CARD

ELGIN, ILLINOIS 60120  
©COPYRIGHT AMERICAN ANTENNA